



If caregivers have a choice, they choose Lopital



Instruction for use Vienna basic & Vienna deluxe Dressing Table



Instruction for use

IFU5030-2025-01 EN

Vienna basic & Vienna deluxe Dressing Table

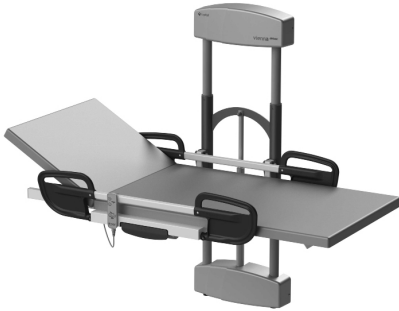

**6500 5030 Vienna deluxe
wall-mounted Dressing Table**

Basic UDI-DI: 872025610360861005030P2



**6500 5035 Vienna basic wall-mounted fixed
height Dressing Table**

Basic UDI-DI: 872025610362265005035LU



If caregivers have a choice, they choose Lopital

Important:

Read these instructions carefully before using the Vienna basic & Vienna deluxe!

Date first used

User

















Name

Address

Manufacturer

Lopital Nederland B.V.
 Laarakkerweg 9, 5061 JR Oisterwijk
 T +31 (0)13 5239300
 www.lopital.nl
 info@lopital.nl

All of the aids produced by Lopital fulfil the following norms for medical products Class 1 (MDR (EU) 2017/745)

Explanation of symbols in 'instructions for use' and on labels			
	Note		Follow the instructions for use.
	Manufacturer details		Read cleaning and disinfecting protocol.
	Date of production		Temperature
	Maximum load		Air pressure
	Article number		Humidity level
	Serialnumber		Antibacterial
	Medical device		Conformité Européenne
	S1 Datamatrix containing the following information: <small>(01) Global Trade Item Number (internationally unique item number) (11) Production date (21) Serial number</small>		Keep the device away from heat, hot surfaces, sparks, open flames, and other ignition sources. No smoking.
	24V DC voltage		

Contents

1. Introduction	5
1.1. Introduction	5
1.2. Safety.....	5
1.3. Warranty.....	7
2. Use	8
3. Operation	11
3.1. Side rail.....	11
3.2. Moving upwards/downwards	11
3.3. Backrest adjustment.....	12
3.4. Changing battery.....	12
3.5. Charging battery.....	13
3.6. Folding up the dressing table.....	14
4. Safety functions	14
4.1. Emergency stop.....	14
4.2. Emergency lowering button	15
5. Cleaning and maintenance	16
6. Environmental conditions.....	17
7. Removal of parts.....	17
8. Technical specifications	18
8.1. Structure.....	18
8.2. Drive	18
8.3. Dimensions	18
9. Checklist for technical problems	21
10. Relation with other supports.....	22
11. Electromagnetic compatibility	22

1. Introduction

1.1. Introduction

The Vienna basic & Vienna deluxe Dressing Table is an aid for the ergonomic care of clients. It offers optimal comfort for both the client and the caregiver. The Vienna deluxe consists of a wall frame and a height-adjustable support surface with a soft lying surface. The dressing table can be mounted on the wall with the head end on either the left or right side. The Vienna deluxe is equipped with a backrest adjustment. There are no “essential performances”.



An antibacterial coating based on silver ions prevents dangerous microorganisms such as bacteria, fungi and algae from multiplying and spreading. The effectiveness was confirmed in several tests. Germs were demonstrably reduced in a short time to 99.99%. The coating only affects bacteria that are found on the surface and not on airborne micro-organisms. The coating protects users or others from disease-causing bacteria, germs, viruses or other harmful organisms. On a dirty surface, the coating loses its antibacterial properties. So proper cleaning and disinfection is still a must.

The Vienna basic & Vienna deluxe is easy to use in combination with other aids such as roll chairs, shower chairs, patient lifts and sliding sheets.

The expected technical life of the Vienna basic / Vienna deluxe is 10 years, assuming it is cleaned daily and regularly maintained according to the maintenance schedule supplied (*See chapter 5. Cleaning and maintenance*).

The Vienna basic & Vienna deluxe is a class 1 medical device with CE-marking. This marking corresponds with regulation MDR (EU) 2017/745. The Vienna basic / Vienna deluxe has been tested for electro-magnetic radiation according to the IEC 60601-1-2.

1.2. Safety



A failure to comply with the following safety points and the further definitions in these instructions for use could lead to hazardous working situations. Please read carefully before use.

Use

- Before you start work with the Vienna deluxe, check that there has been a fully loaded battery placed in the controlbox.
- The electrically powered Vienna deluxe switches to standby after a few seconds, when not in use.
- Notify the client before moving the Vienna basic & Vienna deluxe.
- Be aware of obstacles and persons in the immediately vicinity when moving or adjusting the

dressing table.

- Make sure that the client always places his / her arms / legs within the side rails in order to avoid anything coming jammed.
- Always close the siderails before raising/lowering the Vienna basic / Vienna deluxe with client.
- It is not permitted to load the Vienna deluxe with more than 227 kg / 500 lbs.
- The Vienna basic has a maximum load capacity of 150 kg.
- The Vienna basic & Vienna deluxe is only suitable for caring for one person.
- Use only original parts, supplied by Lopital. The use of non-original parts can cause dangers.
- The use of components (chargers, cables, actuators, batteries, etc.) that have not been supplied by Lopital may result in increased emissions or decreased immunity of the Vienna basic / Vienna deluxe.
- Use the Vienna basic & Vienna deluxe in a clean and tidy working environment.
- Charge battery box in a well-ventilated, dry space.
- Swimming pool locations are not considered to be 'normal conditions' and will substantially shorten the lifespan of certain components.
- The Vienna basic & Vienna deluxe may only be used indoors.
- Don't touch the battery terminals and the client at the same time.
- Portable and mobile RF communication equipment can affect medical devices. Portable RF communications equipment (including peripherals such as antenna cables and external antennas) should be used no closer than 30 cm (12 inches) to any part of the Vienna deluxe / Vienna basic electric including cables specified by the manufacturer. Otherwise, degradation of the performance of this equipment could result.
- Medical electrical devices involve special EMC precautions and must be used as per the EMC information outlined in the instructions for use.
- The emissions characteristics of the Vienna basic / Vienna deluxe electric make it suitable for use in industrial areas and hospitals (CISPR 11 class A). If it is used in a residential environment (for which CISPR 11 class B is normally required) this equipment might not offer adequate protection to radio-frequency communication services. The user might need to take mitigation measures, such as relocating or re-orienting the equipment.
- The Vienna basic & Vienna deluxe must not be used adjacent to or stacked on other products. However, should that be necessitated, it must be checked whether the dressing table functions normally in this configuration too.

Maintenance

- If the charger or cable become damaged, they must be replaced (for Vienna deluxe).
- The Vienna basic & Vienna deluxe must be serviced and inspected at least once a year.
- Servicing and maintenance of the Vienna basic / Vienna deluxe may only be carried out by persons authorized by Lopital.

- Constructive components of the Vienna basic / Vienna deluxe may only be replaced by authorised personnel.
- The Vienna basic & Vienna deluxe shall not be serviced or maintained while in use with a client.
- If erroneous use, transport, an accident or improper maintenance leads to deformation of the Vienna basic / Vienna deluxe, it may no longer be used and you must contact the supplier or manufacturer.

In the event of breakdowns, you must contact Lopital or your local supplier.

E-mail: info@lopital.nl



The Vienna basic & Vienna deluxe may only be operated by persons who have experience working with the target group and have followed the instruction / trainings video's on the website of Lopital.



The Vienna basic & Vienna deluxe has been developed and produced for use in a professional care environment.



Making changes to the construction could affect the safety of the Vienna basic / Vienna deluxe. This will also lead to Lopital's liability and warranty conditions being invalidated. As a result, the Vienna basic / Vienna deluxe will no longer comply with the regulation MDR (EU) 2017/745 for medical devices.



If a serious incident occurs related to this medical device tht affects the caregiver or the client, it must be reported to Lopital or the distributor of the medical device.

1.3. Warranty

All Lopital products are supplied with a 5-year warranty, on construction and / or material faults, unless otherwise stated. In the event of varying warranty terms, the exact period will be indicated on your invoice; this also serves as the warranty itself. Components and batteries that are subject to wear and tear will not fall under warranty unless there are clear construction and / or material faults.

2. Use

The images below show the components of the Vienna basic & Vienna deluxe.
The detachable parts of the dressing table are lying surface and the battery box.

Vienna deluxe (art. nr. 65005030)

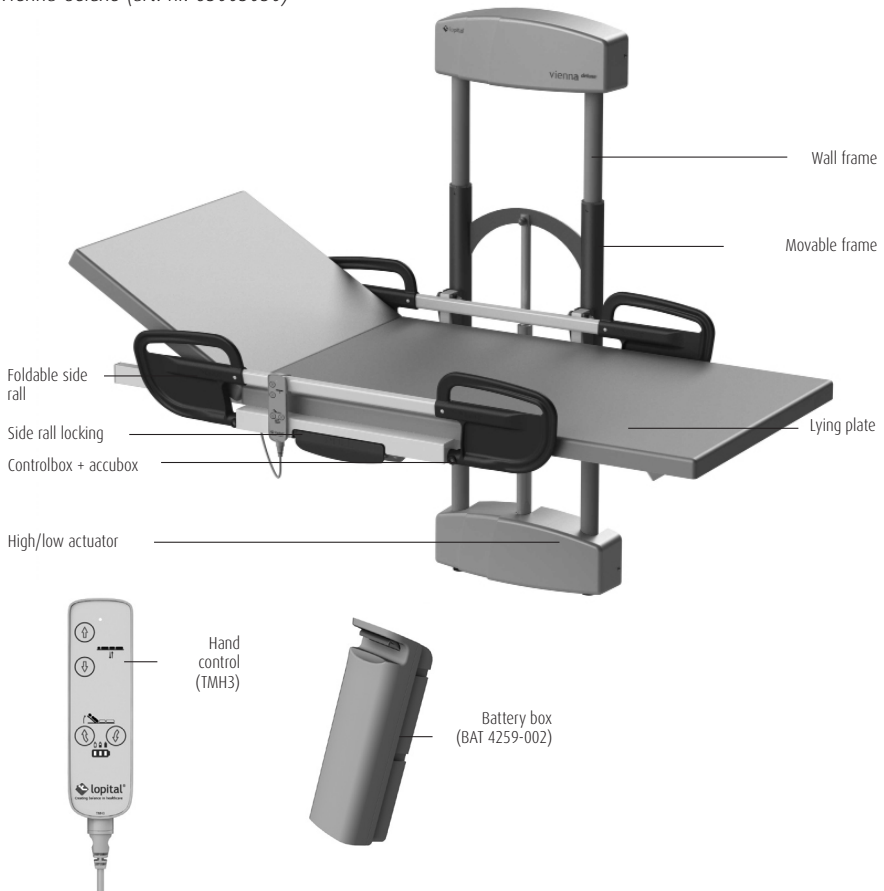

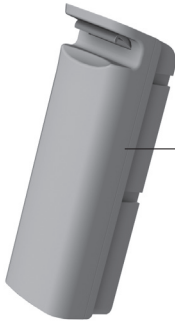

08 T:motion

Part No BAT-4259-002
 IP rating IP66
 Lead-acid battery pack
 To be used with TC12-4259-001





⚠ NOT TO BE OPENED BY UNAUTHORIZED PERSONNEL
 NE PAS OUVRIR PAR DU PERSONNEL NON AUTORISÉ









lopital
 Laarakkerweg 9
 5061 JR Oisterwijk
 The Netherlands
 T: (031) 13-5239900

 _____
 _____
 _____
 _____ KG / _____ LBS
 _____



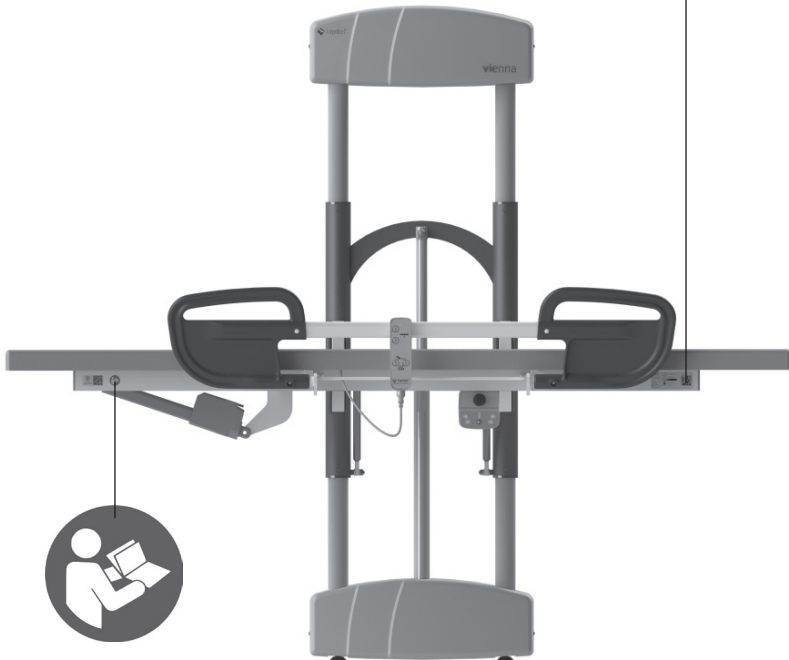

IPX: _____
 Weight: _____ kg
 Type battery: _____
 Drives operates: _____ V
 Charge: _____ V / _____ mA
 Non continuous: _____

 (01) _____
 (11) _____
 (21) _____

Vienna basic (art. nr. 65005035)



	MD	
 Laarakkerweg 9 5061 JR Oisterwijk The Netherlands T: (031)13-5239300	REF	
IPX-	SN	
Weight: -- kg	--- KG/---LB5	
Type battery: ---		
Drives operates: -- V	Revision -
Charge: --- V --- mA	(01)
Non continuous:	(11)
		(21)

3. Operation

3.1. Side rail

- The Vienna basic & Vienna deluxe is equipped with aluminium side rails that can be collapsed so that transfers can be carried out.
- The side rail is equipped with safeguards so that the client cannot raise the side rails themselves (See figure 1).
- Before the side rail is collapsed downwards, the safeguard must be unlocked.
- Unlock the safeguard by using one hand to pull the protruding handle (1) and rotating the side rail with your other hand (2).
- With folded side rails, the caregiver can lean against the mattress in the middle to better care for the patient.
- Turn the side rail upwards again to close the side rail. The side rail locks automatically (See figure 2).
- The side rail can be placed in 2 positions, wide and narrow. When you fold the side rail upwards, the side rail is first locked in the wide position (See figure 3). By pulling the handle of the lock (See figure 2) you can move the side rail further back to its narrow position.

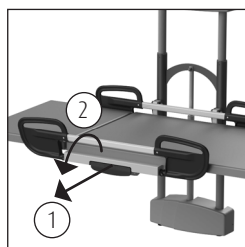

Figure 1 Side rail.

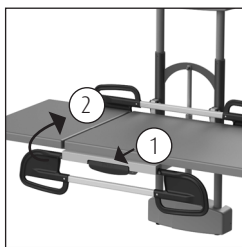

Figure 2 Side rail down.

3.2. Moving upwards/ downwards

Moving upwards

- Move the Vienna deluxe upwards by pressing the button that shows an 'up' arrow. The Vienna deluxe will then immediately move upwards (1) (See figure 3).
- You can stop the movement whenever you like by taking your finger off the button.
- During the upward movement, maintain contact with the client.
- If the remote control is not being used, it can be hung on the side rail.
- Ensure that the curly cable on the operating device does not get jammed.

Moving downwards

- Move the Vienna deluxe downwards by pressing the button that shows a 'down' arrow the dressing table will immediately move downwards (2) (See figure 3).
- You can stop the movement whenever you like by taking your finger off the button.
- During the downward movement, maintain contact with the client.

When the hand control is lost or defect, the Vienna deluxe can be adjusted in height by pressing the buttons on the control box (See figure 4).

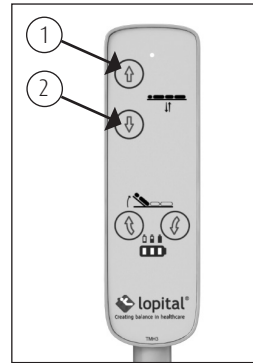

Figure 3 Hand control.



Before moving the Vienna deluxe upwards or downwards, check to ensure there are no persons or objects in the immediately vicinity of the dressing table.

3.3. Backrest adjustment

Electric back adjustment

The stepless electric back adjustment is operated by pressing the buttons on the hand control (See figure 5). Release the button when the backrest is in the correct position.

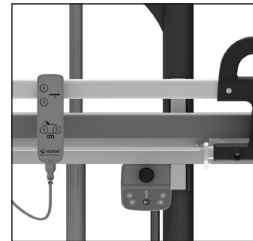

Figure 4 Control box operation.

3.4. Changing battery

The Vienna deluxe is an electrically adjustable high-low dressing table and works on a battery.

- The battery is located at the head-end of the dressing table (See figure 6).
- There is a battery indication on the hand control (See figure 9).
- Charge the battery on the charger station (See figure 7).
- In order to remove the battery, use one hand to unlock the catch (1) on the battery, then slide the battery to the right (2) (See figure 6).
- To install the fully charged battery, it must first be positioned next to the electronic housing and then clicked into the holder.
- You can better insert and remove the battery when the frame is in the folded position.

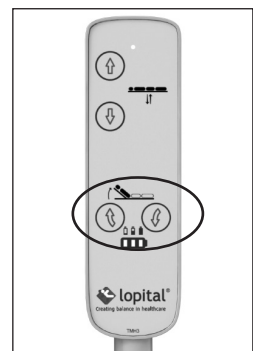

Figure 5 Electrical back adjustment.



Make sure that the Vienna deluxe is always ready for use by having a fully charged reserve battery on standby. If this is not the case, lift the client from the dressing table with a patient hoist or manually with at least 2 persons.



When the battery box is fully charged, it will be able to perform the high / low movement in combination with the back adjustment approximately 45 times.



After 4/5 years it is recommended to replace the battery box.



Only use batteries that are supplied with the Vienna deluxe. The batterybox that is used for the Vienna deluxe is the 'Ti-motion BAT-4259-002' 2.9 Ah, 24 V.

3.5. Charging battery

- Place the battery to be charged on the battery chargestation (See figure 8).
- A green light indicates that the battery charger is switched.
- The charged battery can remain on the battery charger without being damaged.



Charge batteries that are not used, once every six months to avoid damage.



Charging the batteries before they are completely empty will extend their lifespan.



The expected battery lifespan depends on following the manufacturer's charging instructions.



The charger that is used for the Vienna deluxe is the 'Ti-motion TBC2'.



Charge batteries in a well-ventilated, dry space.

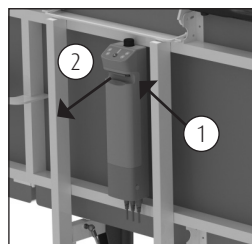

Figure 6 Battery.



Figure 7 Chargestation.



Figure 8 Chargestation with battery.

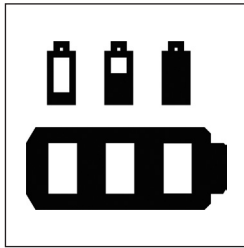

Figure 9 Battery indicator on hand control.



Fully charged.



1/3 capacity,
Charging advised.



2/3 capacity.



Charging required. An acoustic
signal sounds (red light).

3.6. Folding up the dressing table

When the dressing table is not in use, the frame can be folded up. With the Vienna deluxe, the head adjustment must first be set to the flat position.



When folding the changing table up and down, avoid the hinge point to prevent fingers from getting caught.

4. Safety functions

4.1. Emergency stop

On the side of the dressing table, there is an emergency stop. Operate this button in an emergency, if the upward or downward movement must be stopped immediately. Once the emergency stop is pressed, the electronic controls will stop working. The emergency stop interrupts all power.

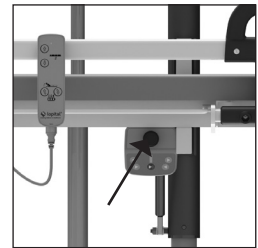

Figure 10 Emergency stop.

Operation may be continued once the situation is stable again. Turn the emergency stop a quarter turn to unlock it again (See figure 10).



First check to ensure the hazard has been removed or the problem has been resolved, before resetting the emergency stop button.



If the button is activated, no leds will light up on the hand control.

4.2. Emergency lowering button

If the handcontrol stop working and the dressing table is in a raised position, it can be lowered using the emergency lowering button. This button is located on the controlbox (See figure 11).

First check to ensure that the emergency button has not been pressed!

- Press the emergency lowering button (See figure 11).

The dressing table will now return to the lowest position (make sure no persons or objects are under the dressing table). Take the client from the dressing table and make sure the device is not used until it has been repaired. Put a sign on the dressing table to indicate that it is out of order.

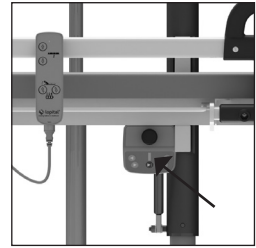

Figure 11 Emergency lowering button.

5. Cleaning and maintenance

The Vienna basic & Vienna deluxe must be cleaned after every use, with water and regular household cleaning agents. Do not use any abrasive or other aggressive cleaning products. If necessary, the lying surface can be disinfected with a solution of 70% ethanol or propanol.

Maintenance and repairs to the Vienna basic / Vienna deluxe may only be carried out by authorised personnel.

Maintenance schedule	
After every use	<ul style="list-style-type: none"> • Clean the Vienna basic & Vienna deluxe with water and regular household cleaning products. • Clean and disinfect the lying surface. • Check to ensure all parts of the Vienna basic / Vienna deluxe are present.
Weekly	<ul style="list-style-type: none"> • Check that the dressing table is still working correctly. • Charge the battery at least once a week.
Annually	<ul style="list-style-type: none"> • According to the regulation MDR (EU) 2017/745 medical devices, the Vienna basic & Vienna deluxe must be maintained in line with the manufacturer's instructions. Those instructions can be found in the maintenance protocol, see website Lopital (www.lopital.com) <p>This process will preferably be carried out by Lopital or another authorised body. Lopital offers the option of having the Vienna basic & Vienna deluxe thoroughly inspected and serviced once a year via Periodic Preventative Maintenance.</p> <p>For more information about the maintenance contract, please contact Lopital (info@lopital.nl) or speak to your supplier.</p>



For a detailed explanation regarding cleaning and disinfecting, see the document 'Cleaning and Disinfection Protocol' on our website www.lopital.com/downloads/.

6. Environmental conditions

Conditions during storage and transport

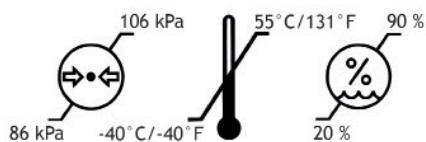

Conditions during use

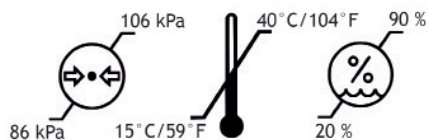

7. Removal of parts

All parts that are replaced or removed can be sent back to Lopital or your supplier. You may also offer the parts to the engineer for destruction. We will ensure that all parts are processed in an environmentally-friendly manner. If you take care of disposal of the product yourself, you must take account of the fact that batteries and chargers must be disposed of as small chemical waste.

8. Technical specifications

The Vienna basic & Vienna deluxe is a dressing table and should not be used in the shower.

8.1. Structure

Frame:	Stainless steel/steel pipes and sheet metal with an antibacterial coating
Covers:	ABS with PMMA coating
Mattressfilm:	PVC
Plastic parts (except covers)	Glass fiber filled PA
Fasteners:	Stainless steel + galvanized steel
Weight 6500 5030:	75 kg
Weight 6500 5035:	73 kg
Maximum load 6500 5030:	227 kg
Maximum load 6500 5035:	150 kg

8.2. Drive

High/low drive:	Elektrick, push-only
Controlbox:	24VDC, max. 250W
Batterybox:	24V, 2.9 Ah
Batery charger:	100-240V AC, 50-60 Hz, max. 1 A, Charge station
Mode of operation:	Non-continuous (10% 2min ON, 18 min OFF)

8.3. Dimensions

Net lying space (lxw):	188x80 cm
Lying surface edge height:	ca. 5 cm
Lying surface height:	minimum 45 cm, maximum 95 cm

Vienna deluxe wall-mounted Dressing Table

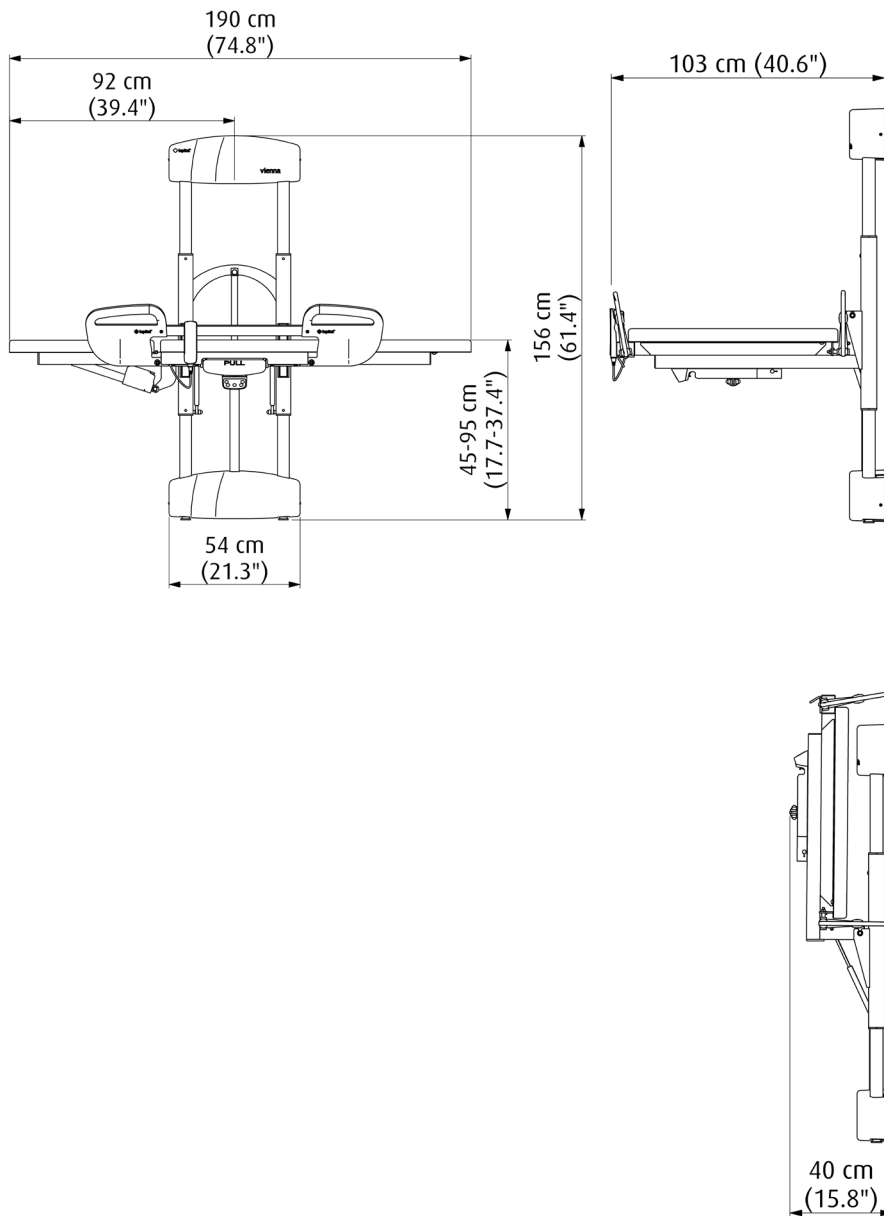

Vienna basic wall-mounted fixed height Dressing Table

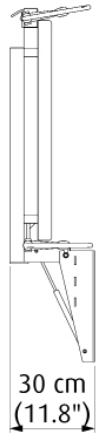
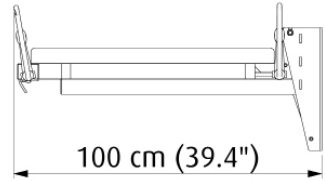
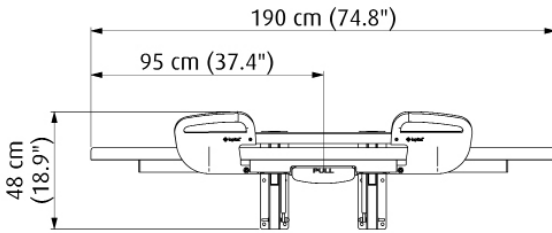

9. Checklist for technical problems

Problem	Cause	Solution
Vienna deluxe does not move upwards or downwards	Emergency button is used.	Turn emergency button 90 degrees to the right.
	Battery empty.	Charge battery or install a new battery.
	Plugs removed.	Check plugs (To side of control box).
	Manual control is not working.	Check plug.
	Motor, pump or control box defect.	Contact Lopital or your supplier.
The light on the charger is not on	(Wall)charger is not plugged in.	Connect charger.
	(Wall)charger is not working.	Contact Lopital or your supplier.
Vienna deluxe stops	Emergency button is used.	Turn the emergency button 90 degrees to the right.
	Technical issue.	Contact Lopital or your supplier.

For all other issues please contact Lopital or your supplier.

Telephone: +31 (0)13 5239300

E-mail: info@lopital.nl

10. Relation with other supports

Hoist / Ceiling hoists

The Vienna basic / Vienna deluxe has been designed for optimal use in combination with a patient lift. The dressing table has a lying surface height of 45 to 95 cm.

Wheelchair

In lower settings of 45-55 cm / 17.7-21.7 inch of the Vienna deluxe, clients can be transferred from dressing table to wheelchair and vice versa. An ideal device to be used during this operation is the small slide sheet (and possibly a sliding board).

11. Electromagnetic compatibility

Professional healthcare environment

Guidance and Manufacturer's declaration-electromagnetic emissions		
The Vienna is intended for use in the electromagnetic environment specified below. The customer or the user of Vienna deluxe should assure that it is used in the following environment:		
Emissions Test	Compliance	Electromagnetic Environment - guidance
RF emissions CISPR11	Group 1	The Vienna uses RF energy only for its internal function. Therefore, its RF emissions are very low and are not likely to cause any interference in nearby electronic equipment
RF emissions CISPR11	Class A	The Vienna is suitable for use in all establishments, other than domestic establishments and those directly connected to the public low-voltage power supply network that supplies buildings used for domestic purposes.
Harmonic emissions IEC 61000-3-2	Not applicable.	
Voltage Fluctuations / Flicker emissions IEC 61000-3-3	Not applicable.	

Guidance and Manufacturer's declaration-electromagnetic immunity			
The Vienna is intended for use in the electromagnetic environment specified below. The customer or the user of the Vienna should assure that it is used in the following environment:			
Immunity Test	IEC 60601-1-2 Test Level	Compliance Level	Elektromagnetik Environment - guidance
Electrostatic discharge (ESD) IEC 61000-4-2	±8 kV contact ±15 kV air	±8 kV contact ±15 kV air	Floors should be made of wood, concrete, or ceramic tile. If floors are covered with synthetic material, the relative humidity should be at least 30%.
Electrical fast transient/burst IEC 61000-4-4	±1 kV for input/output lines	±1 kV for input/output lines	
Surge IEC 61000-4-5	Not applicable.	Not applicable.	
Voltage dips, short interruptions, and voltage variations on power supply input lines IEC 61000-4-11	Not applicable.	Not applicable.	
Power frequency (50/60 Hz) magnetic field IEC 61000-4-8	30 A/m	30 A/m	Power frequency magnetic fields should be at levels characteristic of a typical location in a typical commercial or hospital environment.

Guidance and Manufacturer's declaration-electromagnetic immunity						
The Vienna is intended for use in the electromagnetic environment specified below. The customer or the user of the Vienna should assure that it is used in the following environment:						
Immunity Test	IEC 60601-1-2 Test Level	Compliance Level	Electromagnetic Environment - guidance			
RF Common mode/ Conducted Susceptibility IEC 61000-4-6	3 Vrms 6 V in ISM bands 150 kHz to 80 MHz	3 V 6 V in ISM bands				
Radiated RF Electromagnetic Field IEC 61000-4-3	3 V/m 80 MHz tot 2,7 GHz	3 V/m				
Proximity fields from RF wireless communication systems IEC 61000-4-3	Refer to table below	Refer to table below				
Test frequency (MHz)	Band ^{a)} (MHz)	Service ^{a)}	Modulation ^{b)}	Maximum power (W)	Distance (m)	Immunity test level (V/m)
385	380 - 390	TETRA 400	Puls modulation ^{b)} 18 Hz	1,8	0,3	27
450	430 - 470	GMRS 460, FRS 460	FM ^{c)} ± 5 kHz deviation 1 kHz sine	2	0,3	28
710	704 - 787	LTE Band 13, 17	Puls modulation ^{b)} 217 Hz	0,2	0,3	9
745						
780						
810	800 - 960	GSM 800/900, TETRA 800, iDEN 820, CDMA 850, LTE Band 5	Puls modulation ^{b)} 18 Hz	2	0,3	28
870						
930						
1720	1 700 - 1 990	GSM 1800; CDMA 1900; GSM 1900; DECT; LTE Band 1, 3, 4, 25; UMTS	Puls modulation ^{b)} 217 Hz	2	0,3	28
1845						
1970						
2450	2 400 - 2 570	Bluetooth, WLAN, 802.11 b/g/n, RFID 2450, LTE Band 7	Puls modulation ^{b)} 217 Hz	2	0,3	28
5240	5 100 - 5 800	WLAN 802.11 a/n	Puls modulation ^{b)} 217 Hz	0,2	0,3	9
NOTE. If necessary to achieve the IMMUNITY TEST LEVEL, the distance between the transmitting antenna and the ME EQUIPMENT or ME SYSTEM may be reduced to 1 m. The 1 m test distance is permitted by IEC 61000-4-3.						
a) For some services, only the uplink frequencies are included. b) The carrier shall be modulated using a 50 % duty cycle square wave signal. c) As an alternative to FM modulation, 50 % pulse modulation at 18 Hz may be used because while it does not represent actual modulation, it would be worst case.						



If caregivers have a choice, they choose Lopital



For more information also visit our website: www.lopital.com

Lopital Nederland B.V. Laarakkerweg 9, 5061 JR Oisterwijk, Postbus 56,
5060 AB Oisterwijk, Tel +31 (0)13.52.39.300, E-mail info@lopital.nl,
www.lopital.nl



Green Deal

MADE IN
THE NETHERLANDS



ISO CERTIFIED
9001 - 13485 - 14001



Copyright © 2025 Lopital. All rights reserved.