

The Bravo fire pit is handmade by Dekko in North America. Ships with your choice of NG or LP burner, one decorative aggregate option and chrome On/Off key.

Size: 32"W x 32"D x 13"H
 CSA/US Approved Burner Assembly



	Manual Ignition	Electronic Ignition
BTU/Hr	65,000	90,000
Weight	115 lbs	115 lbs
Fuel Options	NG/LP	NG/LP

Optional Accessories:

- Propane Tank Cover 16"W x 16"D x 21"H
- Glass Wind Guard 23"D x 6"H
- Vinyl Weather Cover
- Powder Coated Aluminium Table Top 32"W x 32"D

Colour Options

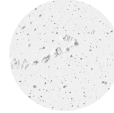

NATURAL

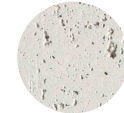

LIMESTONE

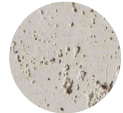

CLAY

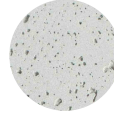

ASH

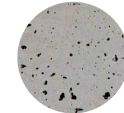

SANDSTONE

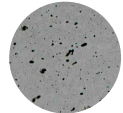

CHARCOAL

Decorative Aggregate Options



IVORY BEACH STONE



SLATE BEACH STONE



BLACK LAVA ROCK

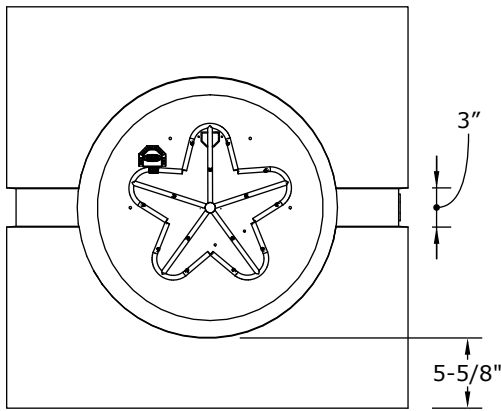

PLAN VIEW

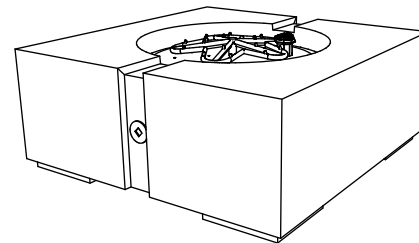

PERSPECTIVE VIEW

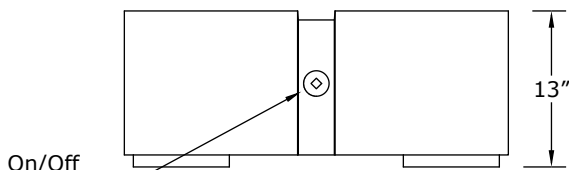

FRONT ELEVATION

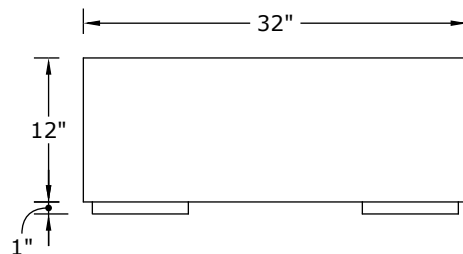

SIDE ELEVATION

Clearances

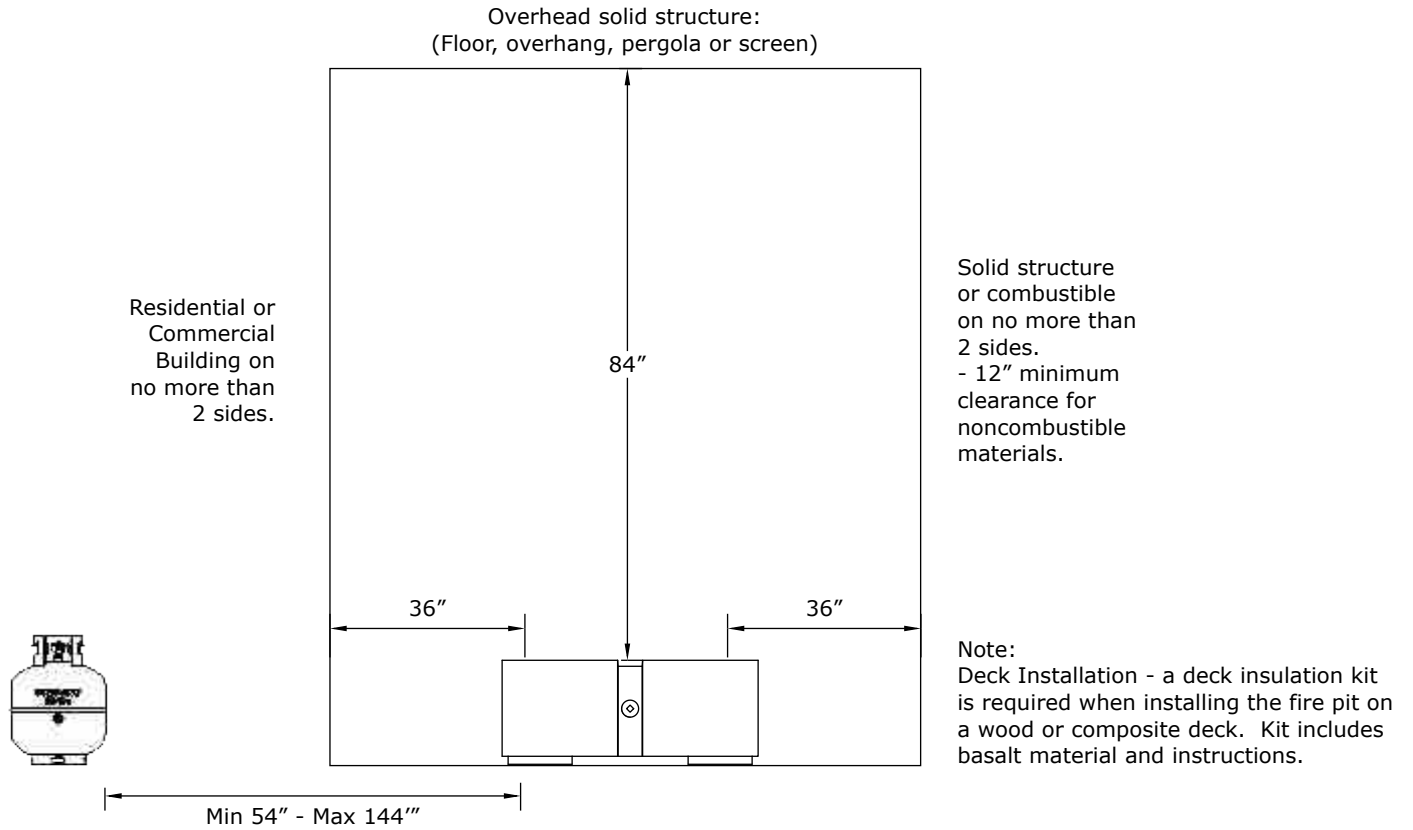

Burner Assembly

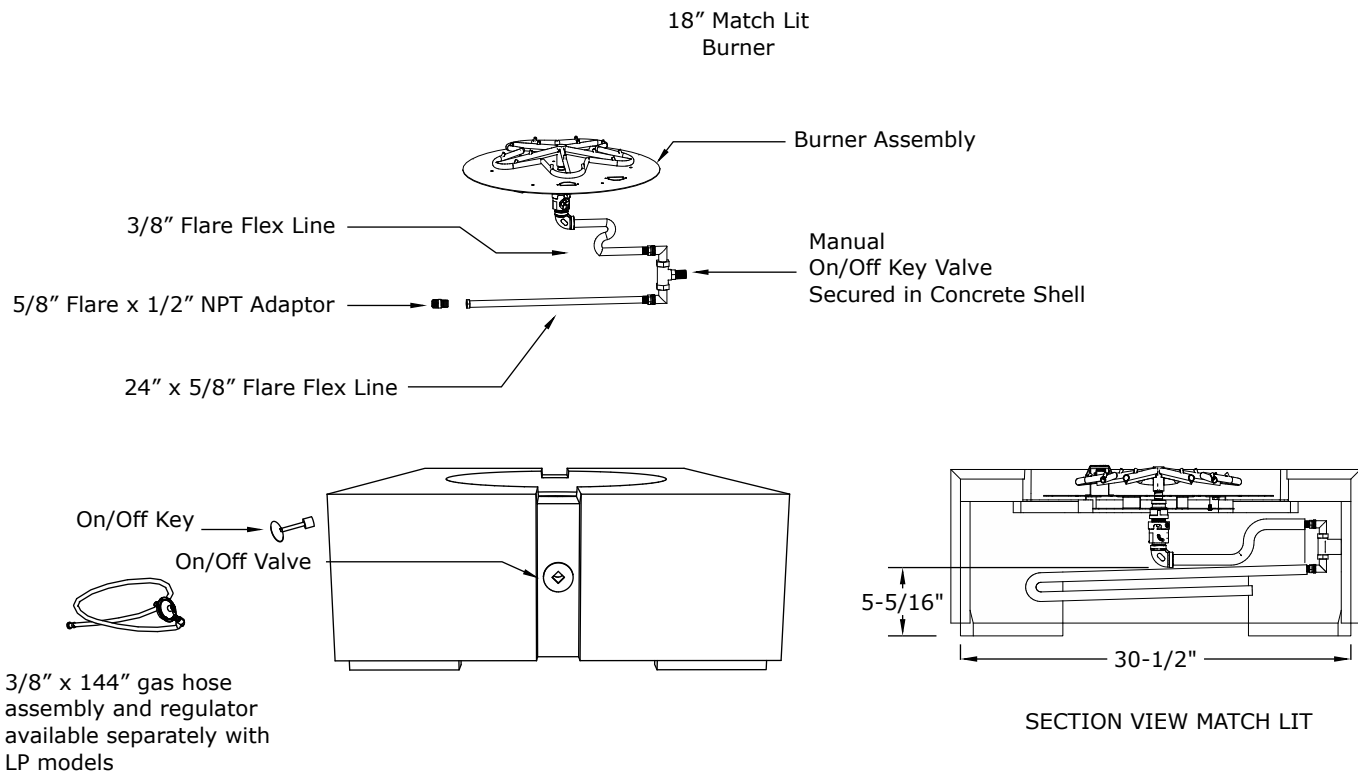

Clearances

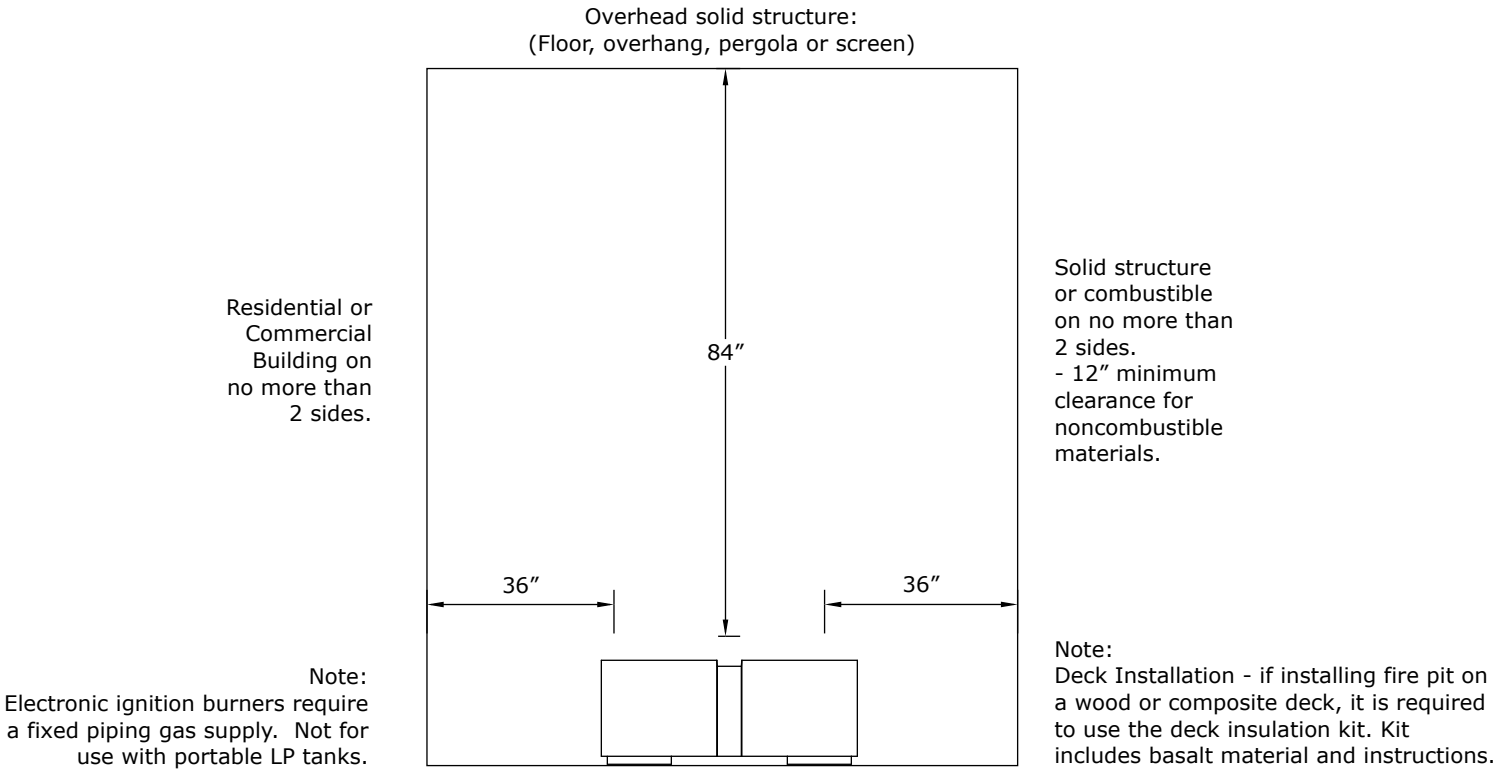

Burner Assembly

Electrical:
120V Outdoor receptacle required.
Must be installed and grounded in accordance with local codes.

18" Electronic Ignition Burner

