

P.O./CAS WINDOW

FIXED/CAS WINDOW

SERIES: 3062  
ALUMINUM IMPACT CASEMENT WINDOWS

GLAZING: 1<sup>5</sup>/<sub>16</sub>" LAMINATED INSULATED IMPACT GLASS

SOL-A-TROL

aluminum products  
4101 N.W. 132nd Street  
Miami, Florida 33054  
Phone: (305) 681-2020  
Fax: (305) 681-2035

1

FLANGE  
FRAME

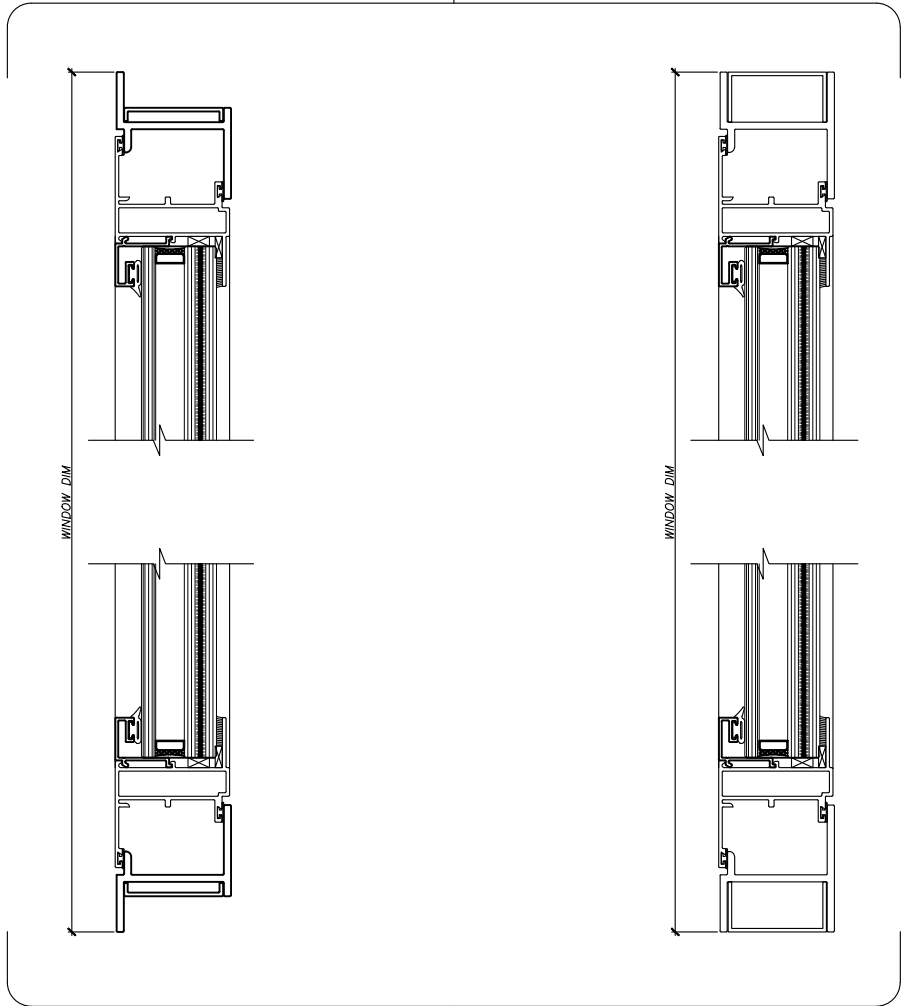

EQUAL  
LEG  
FRAME

2

SERIES: 3062  
ALUMINUM IMPACT CASEMENT WINDOWS

GLAZING: 1<sup>5</sup>/<sub>16</sub>" LAMINATED  
INSULATED IMPACT GLASS



SOL-A-TROL

aluminum products  
4101 N.W. 132nd Street  
Miami, Florida 33054  
Phone: (305) 681-2020  
Fax: (305) 681-2035

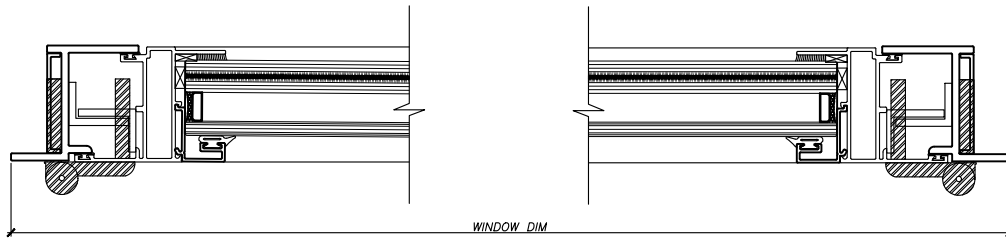

FLANGE  
FRAME

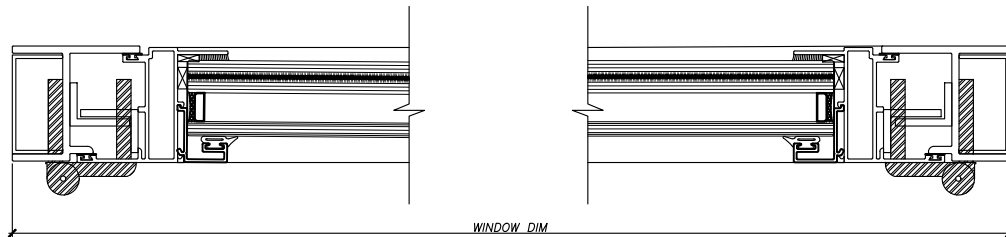

EQUAL  
LEG  
FRAME

SERIES: 3062  
ALUMINUM IMPACT CASEMENT WINDOWS

GLAZING:  $1\frac{5}{16}$ " LAMINATED  
INSULATED IMPACT GLASS

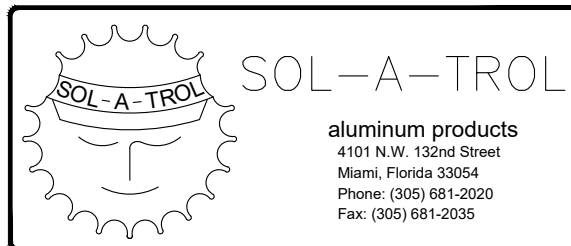

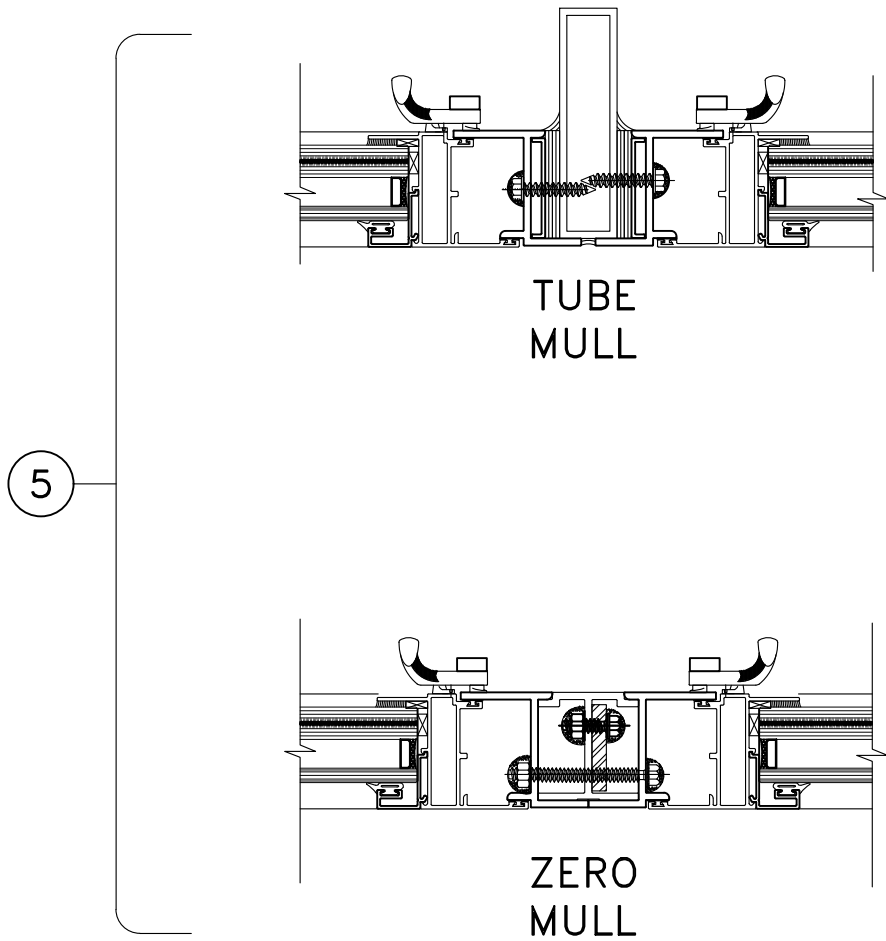

SERIES: 3062  
ALUMINUM IMPACT CASEMENT WINDOWS

GLAZING: 1<sup>5</sup>/<sub>16</sub>" LAMINATED  
INSULATED IMPACT GLASS



6

TUBE  
MULL

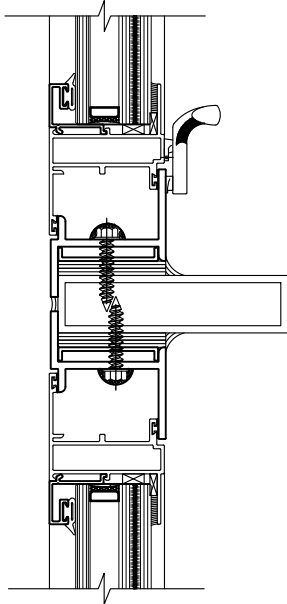

ZERO  
MULL

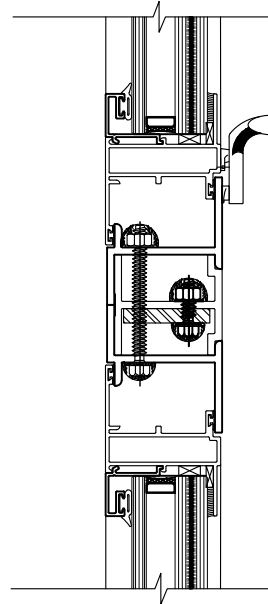

SERIES: 3062  
ALUMINUM IMPACT CASEMENT WINDOWS

GLAZING: 1<sup>5</sup>/<sub>16</sub>" LAMINATED  
INSULATED IMPACT GLASS

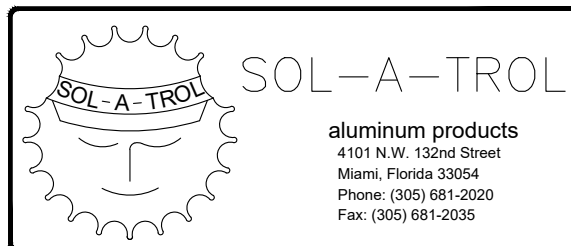

7

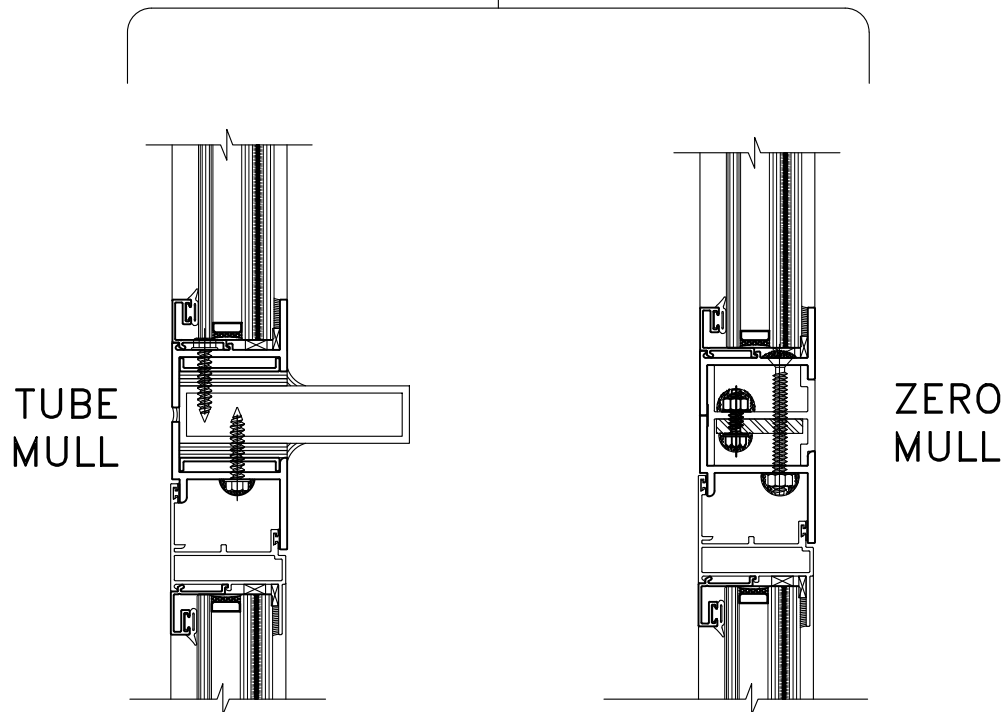

SERIES: 3062  
ALUMINUM IMPACT CASEMENT WINDOWS

GLAZING:  $1\frac{5}{16}$ " LAMINATED  
INSULATED IMPACT GLASS



8



FLANGE  
FRAME

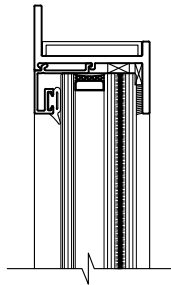

EQUAL  
LEG  
FRAME

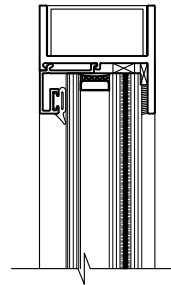

SERIES: 3062  
ALUMINUM IMPACT CASEMENT WINDOWS

GLAZING: 1 $\frac{5}{16}$ " LAMINATED  
INSULATED IMPACT GLASS

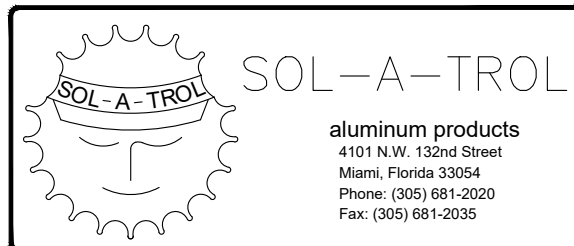

9

FLANGE  
FRAME

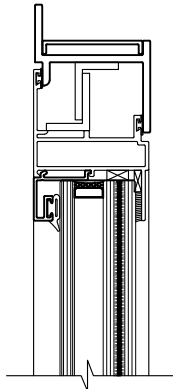

EQUAL  
LEG  
FRAME

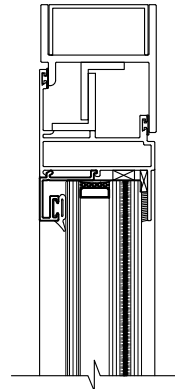

SERIES: 3062  
ALUMINUM IMPACT CASEMENT WINDOWS

GLAZING: 1<sup>5</sup>/<sub>16</sub>" LAMINATED  
INSULATED IMPACT GLASS

