

# PRODUCT CATALOG



# YOUR TRUSTED PARTNER IN PAINTING & BUILDING SUPPLIES



## Paint Application

We design high-efficiency tools tailored for professionals and DIYers alike.

Page 4-31



## Cleaning Products

We offer industrial-grade cleaning products tailored to meet the demands of manufacturers, wholesalers, and retailers. Developed with cutting-edge technology, our cleaning tools ensure and easy application.

Page 32-38



## Construction Products

Our building products stand out for their durability and compatibility with. From rollers to scrapers, each tool is manufactured to support professionals in achieving excellent results.

Page 39-49



## Decorative Products

Add a touch of elegance to your spaces with decorative building products. Designed with high visual appeal and our solutions bring style and function together.

Page 50-53



## Painting Machines

Our machines successfully provide decorative painting and coating of large areas with a high amount of material on interior and Exterior facades.

Page 54



## Display & Stands

Our custom-designed product stands are a perfect match for your store or workspace. Built to be both stylish and functional, they help showcase our products effectively.

Note: All items displayed on stands are sold under standard commercial terms.

Page 55-66

## NEW PRODUCTS



**Premium Squeegee**  
**1411**

40 cm / 12 in a box

Page: 43

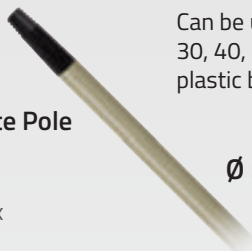

**Extreme Composite Pole**  
**1372**

1,5 m  
12 in a box

Can be used with  
30, 40, 50, 60 cm  
plastic brushes.

Ø : 27 mm

Page: 30



**Broom Holder**  
**7200**

7,8 × 8,3 × 4,6 cm  
24 in a box

Page: 25



**Stiff Bristle Brushes**

Page: 33



**Floor Scrub Brush**  
**6241**

25 cm  
12 in a box

Page: 38



**Epoxy Spiked Rollers**  
**(40-50-60 cm)**

Page: 42



Page: 45

**Scraper with Composite Handle**  
**2225**

30 cm / 6 in a box



Page: 45

**Scraper with Composite Handle**  
**2223**

20 cm / 6 in a box

**Mini Scraper**  
**7002**

4 × 5,8 cm  
20 in package  
24 in box



Page: 44

**Dustpan and Brush Set**  
**6281**

29 × 18 cm  
12 in a box



Page: 38



**Water-Based Robot Brushes**

Page: 5



**Premium Metal Squeegees**

Page: 43



**Water-Based Premium Brushes**

Page: 7



**Water-Based Brushes**

Page: 9

**Adjustable Paint Roller Handle**  
**9099**

2,2" × 13,2" × 5"  
5,7 × 33,5 × 12,7 cm  
2 in a box

It can be used with  
30, 40, 50, 60 cm  
spare rollers.

Page: 26

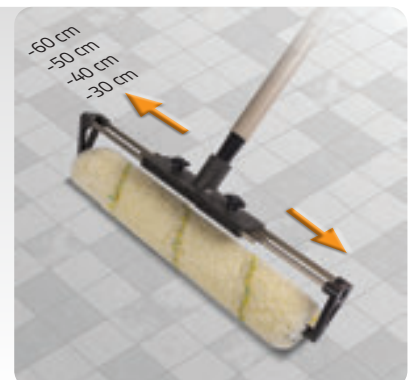

**DEKOR.**

# **ROBOT**

## BRUSHES

Swivel head for  
adjustable angle.

# ROBOT BRUSHES



## Oil-Based Premium Robot Brushes

6467

3"

76 mm

12 in a box



6468

4"

100 mm

12 in a box



## Water-Based Premium Robot Brushes

6477

3"

76 mm

12 in a box



6478

4"

100 mm

12 in a box

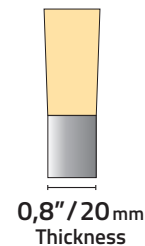

Code	Thickness	Width	Box
6467	0,8" / 20 mm	3" / 76 mm	12
6468	0,8" / 20 mm	4" / 100 mm	12
6477	0,8" / 20 mm	3" / 76 mm	12
6478	0,8" / 20 mm	4" / 100 mm	12

## Water-Based Robot Brushes

6177

#3

2,5" / 64 mm

12 in a box



6178

#4

3,3" / 84 mm

12 in a box

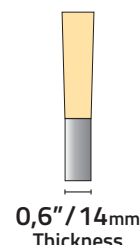

Designed for versatility, our Robot Brushes feature swivel heads to reach any angle with ease. Equipped with ergonomic handles and durable bristles solvents, they offer clean, trace ideal for corners and hard-to-reach areas.

Code	Type	Thickness	Width	Box
6177	#3	0,6" / 14 mm	2,5" / 64 mm	12
6178	#4	0,6" / 14 mm	3,3" / 84mm	12

DEKOR.

# WATER-BASED PREMIUM BRUSHES



# WATER-BASED PREMIUM BRUSHES



**NEW**

**6474**

**3"**

76 mm

12 in a box

Long bristle length provides a comfortable soft paint application without trace.

Special formula helps holds more paint.

Plastic comfortable handle provides a smooth application and ergonomic hold.



**NEW**

**6475**

**4"**

100 mm

12 in a box



**NEW**

**6472**

**2"**

50 mm

12 in a box



**NEW**

**6470**

**1"**

25 mm

12 in a box

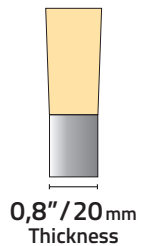

Ideal for both detail work and general applications, these chip brushes are rust-resistant and easy to handle. They hold paint well and provide a seamless finish across surfaces.

Code	Thickness	Width	Box
6470	0,8" / 20 mm	1" / 25 mm	12
6472	0,8" / 20 mm	2" / 50 mm	12
6474	0,8" / 20 mm	3" / 76 mm	12
6475	0,8" / 20 mm	4" / 100 mm	12

**DEKOR.**

# **WATER-BASED**

BRUSHES



# WATER-BASED BRUSHES



**NEW**

**6174**

**#3**

2,5" / 64 mm

12 in a box



Special formula helps holds more paint.

Long bristle length provides a comfortable soft paint application without trace.

Plastic comfortable handle provides a smooth application and ergonomic hold.



**6170**

**#1**

1" / 24 mm

12 in a box



**NEW**



0,6" / 14mm  
Thickness

**6175**

**#4**

3,3" / 84 mm

12 in a box



**NEW**

**6172**

**#2**

1,7" / 44 mm

12 in a box



**NEW**

**6176**

**#5**

4" / 100 mm

12 in a box



**NEW**

Code	Type	Thickness	Width	Box
6170	#1	0,6" / 14 mm	1" / 24 mm	12
6172	#2	0,6" / 14 mm	1,7" / 44 mm	12
6174	#3	0,6" / 14 mm	2,5" / 64 mm	12
6175	#4	0,6" / 14 mm	3,3" / 84 mm	12
6176	#5	0,6" / 14 mm	4" / 100 mm	12

Ideal for both detail work and general applications, these chip brushes are rust-resistant and easy to handle. They hold paint well and provide a seamless finish across surfaces.

# EKSPORT

## EMULSION

## PAINT ROLLER

Used on plane faces with satin and water-based paints. Efficiency of the roll, which is not affected by solvents, increases as used. Washing the roll with any solvent after using and rinsing with water prolongs the service life.



Eksport Radiator Roller

<b>1084</b>	4" / 10 cm
	50 in a box

Eksport Robot Roller

<b>2084</b>	4" / 10 cm
	12 in a box



Eksport Roller

<b>1080</b>	8" / 20 cm
	25 in a box



Eksport Mid-size & Radiator Roller

<b>3113</b>	6" / 15 cm
	25 in a box

Code	Length	Box
Radiator Roller		
2086	10" / 25 cm	50
2083	8" / 20 cm	50
1085	6" / 15 cm	50
1084	4" / 10 cm	50
1087	3" / 7,5 cm	50
1094	2" / 5 cm	50

Code	Length	Box
Radiator Roller Sleeves		
2186	10" / 25 cm	50
2183	8" / 20 cm	50
1101	6" / 15 cm	50
1100	4" / 10 cm	50
1104	3" / 7,5 cm	50
1103	2" / 5 cm	50

Code	Length	Box
Eksport Robot Roller		
2084	4" / 10 cm	12

Code	Length	Box
Roller		
1081	10" / 25 cm	25
1093	9" / 23 cm	25
1080	8" / 20 cm	25
1082	6" / 15 cm	25
1083	4" / 10 cm	25

Code	Length	Box
Roller Sleeves		
1097	10" / 25 cm	25
1110	9" / 23 cm	25
1096	8" / 20 cm	25
1099	6" / 15 cm	25
1098	4" / 10 cm	25

Engineered for precision and flexibility, these rollers come in various sizes to suit all surface types — including tight spaces like behind radiators.

Code	Length	Box
Mid-size Roller		
3116	10" / 25 cm	25
3115	8" / 20 cm	25
3113	6" / 15 cm	25
3111	4" / 10 cm	25

Code	Length	Box
Mid-size Roller Sleeves		
3016	10" / 25 cm	25
3015	8" / 20 cm	25
3013	6" / 15 cm	25
3011	4" / 10 cm	25



Eksport Radiator Roller Sleeve  
12 in a package

<b>2100</b>	4" / 10 cm
	12 in a box



Eksport Radiator Roller Sleeve  
6 in a package

<b>2106</b>	4" / 10 cm
	24 in a box



Eksport Radiator Roller Sleeve  
3 in a package

<b>3100</b>	4" / 10 cm
	24 in a box



Eksport Roller

<b>1089</b>	12" / 30 cm
	6 in a box



**Adjustable Paint Roller Handle**  
**9099**

2,2" × 13,2" × 5"  
5,7 × 33,5 × 12,7 cm  
2 in a box



It can be used with 30, 40, 50, 60 cm spare rollers.



Radiator Roller	Mid-size Roller	Normal Roller
Ø 1" / 2,5 cm	Ø 1,4" / 3,5 cm	Ø 2,2" / 5,5 cm



Ideal for applying paint or drywall to a room's corners. The angled head is ideal for painting gutters or siding around conduit.

Eksport Corner Roller

<b>1086</b>	1,4" / 3,5 cm
	6 in a box



Pipe roller supports with spring, helps you paint various diameters pipe painting jobs easier.

Eksport Tube Roller

<b>1088</b>	2,8" / 7 cm
	6 in a box

Code	Length	Box
Radiator Roller 12 in a Package		
2100	4" / 10 cm	12
Radiator Roller 6 in a Package		
2106	4" / 10 cm	24
Radiator Roller 3 in a Package		
3100	4" / 10 cm	24
Radiator Roller Sleeve Set		
4100	4" / 10 cm	30
Eksport Roller		
1092	23,6" / 60 cm	6
1091	19,7" / 50 cm	6
1090	15,7" / 40 cm	6
1089	11,8" / 30 cm	6
Eksport Roller Sleeves		
1109	23,6" / 60 cm	20
1108	19,7" / 50 cm	20
1107	15,7" / 40 cm	20
1106	11,8" / 30 cm	20
Corner Roller		
1086	1,4" / 3,5 cm	6
Corner Roller Sleeve		
1095	1,4" / 3,5 cm	6
Pipe Roller		
1088	2,8" / 7 cm	6
Pipe Roller Sleeves		
1105	2,8" / 7 cm	6

**DEKOR.**

# **PLASDEK**

## ROLLER

# PLASDEK ROLLER

DEKOR.

Designed for plastic-based paint applications, these rollers retain their effectiveness over time and are compatible with polyester applications as well.



Plasdek Roller

1015	8" / 20 cm
	25 in a box

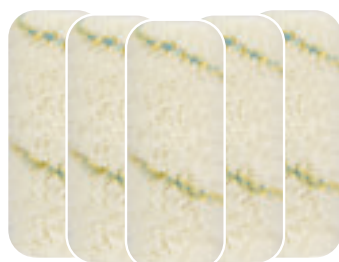

Plasdek  
Roller Sleeve

1026	8" / 20 cm
	25 in a box



Plasdek  
Roller

1019	4" / 10 cm
	25 in a box



Plasdek  
Roller

1420	11,8" / 30 cm
	6 in a box

Code	Length	Box
1017	10" / 25 cm	25
1016	9" / 23 cm	25
1015	8" / 20 cm	25
1018	6" / 15 cm	25
1019	4" / 10 cm	25

Sleeves

1027	10" / 25 cm	25
1025	9" / 23 cm	25
1026	8" / 20 cm	25
1028	6" / 15 cm	25
1029	4" / 10 cm	25

Large Roller

1423	23,6" / 60 cm	6
1422	19,7" / 50 cm	6
1421	15,7" / 40 cm	6
1420	11,8" / 30 cm	6

Large Roller Sleeves

1033	23,6" / 60 cm	20
1032	19,7" / 50 cm	20
1031	15,7" / 40 cm	20
1030	11,8" / 30 cm	20

Adjustable Paint  
Roller Handle

9099

2,2" x 13,2" x 5"  
5,7 x 33,5 x 12,7 cm  
2 in a box



It can be used with  
30, 40, 50, 60 cm  
spare rollers.

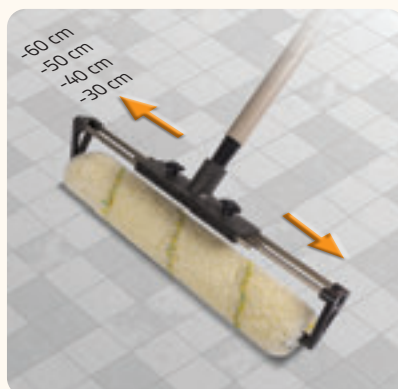

DEKOR.

# **SUPERLUKS**

MASONRY PAINT  
ROLLER

# SUPERLUKS

## MASONRY PAINT ROLLER

DEKOR.

Superluks Roller

1001	8" / 20 cm
	25 in a box

Superluks Roller is used for External house-paints. Efficiency of the roll, which is not affected by solvents, increases as used. Washing the roll with any solvent after using and rinsing with water prolongs the service life.



Superluks  
Roller

1005	4" / 10 cm
	25 in a box



Superluks  
Sleeve

1020	8" / 20 cm
	25 in a box

Code	Length	Box
1003	10" / 25 cm	25
1002	9" / 23 cm	25
1001	8" / 20 cm	25
1004	6" / 15 cm	25
1005	4" / 10 cm	25

Sleeves

1022	10" / 25 cm	25
1021	9" / 23 cm	25
1020	8" / 20 cm	25
1023	6" / 15 cm	25
1024	4" / 10 cm	25

**DEKOR.**

# SILTEKS

SILICON MASONRY  
PAINT ROLLER



# SILTEKS

## SILICON MASONRY PAINT ROLLER

DEKOR.

Silteks Roller

1010	8" / 20 cm
	25 in a box



Silteks Roller

1011	9" / 23 cm
	25 in a box



Silteks Roller

1012	10" / 25 cm
	25 in a box

Specifically made for silicone-based exterior paints, these rollers offer long-lasting performance and smooth application.



Silteks Sleeve

1013	8" / 20 cm
	25 in a box



Code	Length	Box
1012	10" / 25 cm	25
1011	9" / 23 cm	25
1010	8" / 20 cm	25

#### Sleeves

1014	10" / 25 cm	25
1009	9" / 23 cm	25
1013	8" / 20 cm	25

# SHEEPSKIN

roller



# SHEEPSKIN ROLLER

DEKOR®



Sheepskin Roller

1037	6" / 15 cm
	12 in a box

Used in plastic paint and External house-painting applications. Made of natural lamb and sheep fleece.



Sheepskin Roller

1038	4" / 10 cm
	12 in a box



Sheepskin Sleeve

1050	8" / 20 cm
	25 in a box

Code	Length	Box
1036	10" / 25 cm	12
1035	8" / 20 cm	12
1037	6" / 15 cm	12
1038	4" / 10 cm	12

Sleeves

1051	10" / 25 cm	25
1050	8" / 20 cm	25
1045	6" / 15 cm	25
1052	4" / 10 cm	25

Extra Sheepskin Roller

1040	8" / 20 cm	12
------	------------	----

Radiator Roller

1039	4" / 10 cm	50
------	------------	----

Radiator Roller Sleeve

1053	4" / 10 cm	50
------	------------	----

# VARNISH & OIL PAINT ROLLER

# VARNISH & OIL PAINT ROLLER

Designed for oil-based paints and varnishes, these rollers maintain their form and effectiveness through repeated use. They are easy to clean and help achieve a smooth surface.



Varnish & Oil  
Paints Roller

**1065**

8" / 20 cm  
25 in a box



Varnish  
& Oil Paints  
Radiator Roller

**2090**

2" / 5 cm  
25 in a box



Radiator  
Roller  
Ø 1"  
2,5 cm

Mid-size  
Roller  
Ø 1,4"  
3,5 cm

Normal  
Roller  
Ø 2,2"  
5,5 cm

Code	Length	Box
1064	10" / 25 cm	25
1065	8" / 20 cm	25
1067	6" / 15 cm	25
1066	4" / 10 cm	25

#### Sleeves

1075	10" / 25 cm	25
1076	8" / 20 cm	25
1077	6" / 15 cm	25
1078	4" / 10 cm	25

#### Radiator Roller

2085	10" / 25 cm	50
2093	8" / 20 cm	50
1069	6" / 15 cm	50
1068	4" / 10 cm	50
2068	4" / 10 cm	50
2090	2" / 5 cm	25

#### Radiator Roller Sleeves

2185	10" / 25 cm	50
2193	8" / 20 cm	50
1072	6" / 15 cm	50
1079	4" / 10 cm	50
2089	2" / 5 cm	50



Varnish  
& Oil Paints  
Radiator Roller  
(Short handle)

**2068**

4" / 10 cm  
50 in a box



Varnish  
& Oil Paints  
Radiator Roller

**1068**

4" / 10 cm  
50 in a box

Varnish & Oil  
Paints Mid-size  
Roller

**3103**

6" / 15 cm  
25 in a box



Code	Length	Box
Mid-size Roller		
3106	10" / 25 cm	25
3105	8" / 20 cm	25
3103	6" / 15 cm	25
3101	4" / 10 cm	25

#### Mid-size Roller Sleeve

3006	10" / 25 cm	25
3005	8" / 20 cm	25
3003	6" / 15 cm	25
3001	4" / 10 cm	25

**DEKOR.**

# **FOAM**

## PAINT ROLLER



# FOAM PAINT ROLLER



Foam Paint Roller

1112	8" / 20 cm
	12 in a box



Foam Radiator Roller

1115	4" / 10 cm
	25 in a box

Ideal for gloss paints, foam rollers ensure a flawless finish without brush marks. Available in standard and radiator sizes for all your detailed work.



Foam Radiator Roller

1111	2" / 5 cm
	50 in a box



Foam Paint Roller

1114	4" / 10 cm
	25 in a box



Mini Paint Tray

1184	5,7" x 9,2" x 1,8"
	14,5 x 23,5 x 4,5 cm
	12 in a box

Code	Length	Box
1113	9" / 23 cm	12
1112	8" / 20 cm	12
1114	4" / 10 cm	25

Sleeves

1131	9" / 23 cm	25
1130	8" / 20 cm	25
1133	4" / 10 cm	25

Radiator Roller

1115	4" / 10 cm	25
1111	2" / 5 cm	50

Radiator Roller Sleeves

1132	4" / 10 cm	50
1134	2" / 5 cm	50

# VELUKS ROLLER

The paint roller helps the paint spread smoothly and evenly on the surface, reducing brush marks and air bubbles. It is used, especially on smooth surfaces and for hobby painting projects. To ensure a smooth finishing paint process, you can move gently and slowly over the surface without applying additional paint to the roller as there is still wet paint on the surface.



Veluks  
Radiator Roller

1682	4" / 10 cm
	50 in a box



Veluks Radiator  
Roller Sleeve

1672	4" / 10 cm
	50 in a box



Veluks Radiator Roller  
Sleeve 6 in a package

1676	4" / 10 cm
	24 in a box



Code	Length	Box
Radiator Roller		
1682	4" / 10 cm	50
Radiator Roller Sleeves		
1672	4" / 10 cm	50
Radiator Roller 6 in a Package		
1676	4" / 10 cm	24

# PAINT ACCESSORIES



19 LITER PAINT



Jumbo Paint Bucket

1141	16,1" × 21,3" × 8,3"
	41 × 54 × 21 cm
	5 gallon / 19 lt paint
	6 in a box

11 LITER PAINT



Large Painter Set

1180	13,8" × 19,7" × 8,3"
	35 × 50 × 21 cm
	3 gallon / 11 lt paint
	4 in a box



It's a functional painter's container with a volume of 3 gal. / 11 liters consisting of 3 pieces. Includes 2-cell tankard and paint roller grid attachable on large painter's container. Tankard consists of brush keeping cell and paint cell.

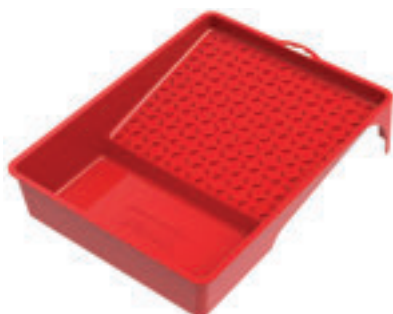

Paint Tray  
(for 8" / 20 cm paint roller)

1219	10" × 13,8" × 2,8"
	25,5 × 35 × 7,2 cm
	12 in a box

Small Paint Tray

1179	6" × 13,6" × 1,8"
	15 × 34,5 × 4,5 cm
	12 in a box



Paint Tray Liner

1183	12,6" × 15,7" × 4,1"
	32 × 40 × 10,5 cm
	50 in a box

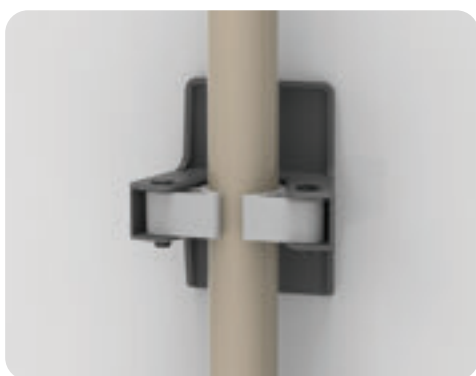

Sturdy and easy to clean, our paint trays are ideal for all types of rollers. Liners help extend the life of your trays by allowing quick changes between colors.



Broom Holder

7200	7,8 × 8,3 × 4,6 cm
	24 in a box

Paint Tray

1181	12,6" × 15,7" × 4,1"
	32 × 40 × 10,5 cm
	10 in a box

Code	Dimensions	Box
1141	41 × 54 × 21 cm	6
1179	15 × 34,5 × 4,5 cm	12
1180	35 × 50 × 21 cm	4
1181	32 × 40 × 10,5 cm	10
1183	32 × 40 × 10,5 cm	50
1219	25,5 × 35 × 7,2 cm	12
7200	7,8 × 8,3 × 4,6 cm	24



Radiator Paint Grid

<b>1197</b>	6" × 13,6" × 1,3"
	15 × 34,5 × 3,3 cm
	40 in a box

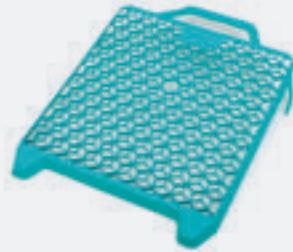

Paint Grid

<b>1185</b>	10,2" × 13,4" × 1,6"
	26 × 34 × 4 cm
	24 in a box



Our flexible and durable paint roller grids fit securely in paint buckets and ensure even loading of paint onto rollers, reducing mess and improving efficiency.



Amateur Paint Set

<b>1190</b>	12,6" × 15,7" × 4,1"
	32 × 40 × 10,5 cm
	2 in a box

- Paint Tray
- 8" / 20 cm Eksport Paint Roller
- 4" / 10 cm Eksport Radiator Roller
- 2,4" / 60 mm Paint Brush
- 32,80 ft / 10 meter Plastic Sheet

All-in-one kits designed for beginners and DIYers. Includes rollers, trays, brushes, and protective sheets everything you need to get started.



Hobby Paint Set

<b>1182</b>	5,7" × 9,2" × 1,8"
	14,5 × 23,5 × 4,5 cm
	12 in a box

- Paint Tray
- 2" / 5 cm Varnish & Oil Paints Radiator Roller
- 2" / 5 cm Varnish & Oil Paints Radiator Roller Sleeve
- Number 10 Pencil Brush
- 0,8" / 20 mm Paint Brush

Paint Paddle Sticks

<b>1390</b>	13"
	33 cm
	40 in a box



Paint Paddle Sticks (Perforated)

<b>1391</b>	13"
	33 cm
	40 in a box



Mini Paint Tray

<b>1184</b>	5,7" × 9,2" × 1,8"
	14,5 × 23,5 × 4,5 cm
	12 in a box



Robot Brush

<b>1188</b>	7"
	18 cm
	12 in a box

Facilitates paint applications in narrow and difficult areas where shortcut is required with the adjustable movable head inserted on the rod end without a stair needed.



Paint Cup

<b>1392</b>	4" × 8,3" × 4,6"
	10,2 × 21 × 11,8 cm
	6 in a box

Code	Dimensions	Box
1182	14,5 × 23,5 × 4,5 cm	12
1184	14,5 × 23,5 × 4,5 cm	12
1185	26 × 34 × 4 cm	24
1188	18 cm	12
1190	32 × 40 × 10,5 cm	2
1197	15 × 34,5 × 3,3 cm	40
1390	33 cm	40
1391	33 cm	40
1392	10,2 × 21 × 11,8 cm	6
9099	5,7 × 33,5 × 12,7 cm	2

**Adjustable Paint Roller Handle 9099**

5,7 × 33,5 × 12,7 cm  
2 in a box



It can be used with 30, 40, 50, 60 cm spare rollers.

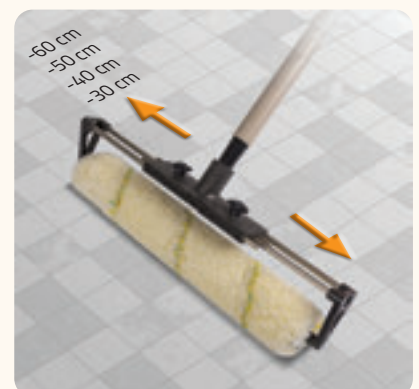

# BUCKETS & CUPS

From jumbo buckets to handheld paint cups, our containers are ergonomically designed and built to last. Great for transporting and organizing paint with minimal waste.

**DEKOR.**

19 LITER  
PAINT



Premium Jumbo  
Paint Bucket

1487	16,1" × 21,3" × 8,3"
	41 × 54 × 21 cm
	5 gallon / 19 lt paint
	6 in a box

11 LITER  
PAINT



Premium Large  
Paint Bucket

1486	13,8" × 19,7" × 8,3"
	35 × 50 × 21 cm
	3 gallon / 11 lt paint
	4 in a box

Premium Paint Tray  
(for 8" / 20 cm paint roller)

1484	10" × 13,8" × 2,8"
	25,5 × 35 × 7,2 cm
	12 in a box



Premium Paint Tray  
(for 10" / 25 cm paint roller)

1485	12,6" × 15,7" × 4,1"
	32 × 40 × 10,5 cm
	10 in a box



Premium Small  
Paint Tray

1483	6" × 13,6" × 1,8"
	15 × 34,5 × 4,5 cm
	12 in a box



Premium Hobby  
Paint Tray

1482	5,7" × 9,2" × 1,8"
	14,5 × 23,5 × 4,5 cm
	12 in a box



Premium Paint Grid  
(for 10" / 25 cm paint roller)

1481	10,2" × 13,4" × 1,6"
	26 × 34 × 4 cm
	24 in a box



Premium Paint Grid  
(for 4" / 10 cm paint roller)

1480	6" × 13,6" × 1,3"
	15 × 34,5 × 3,3 cm
	40 in a box



Premium Paint Set

1491	12,6" × 15,7" × 4,1"
	32 × 40 × 10,5 cm
	2 in a box



Premium Hobby Paint Set

1490	5,7" × 9,2" × 1,8"
	14,5 × 23,5 × 4,5 cm
	12 in a box

- Paint Tray
- 8" / 20 cm Eksport Paint Roller
- 4" / 10 cm Eksport Radiator Roller

- Paint Tray
- 2" / 5 cm Foam Radiator Roller
- 2" / 5 cm Foam Radiator Roller Sleeve

Code	Dimensions	Box
1480	15 × 34,5 × 3,3 cm	40
1481	26 × 34 × 4 cm	24
1482	14,5 × 23,5 × 4,5 cm	12
1483	15 × 34,5 × 4,5 cm	12
1484	25,5 × 35 × 7,2 cm	12
1485	32 × 40 × 10,5 cm	10
1486	35 × 50 × 21 cm	4
1487	41 × 54 × 21 cm	6
1490	14,5 × 23,5 × 4,5 cm	12
1491	32 × 40 × 10,5 cm	2

# MASKING TAPE



**Premium**

Code	Width	Length	Box
7300	1" / 25 mm	164' / 50 m	48
7301	2" / 50 mm	164' / 50 m	24



**Washi Paper**

Code	Width	Length	Box
7310	1" / 25 mm	164' / 50 m	64
7311	2" / 50 mm	164' / 50 m	32

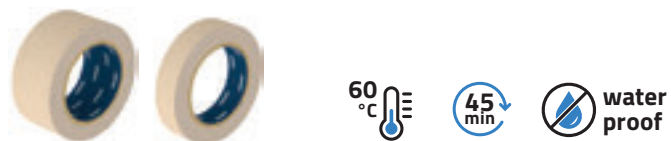

**Natural Rubber**

Code	Width	Length	Box
7320	1" / 25 mm	164' / 50 m	48
7321	2" / 50 mm	164' / 50 m	24



# FLOOR PROTECTOR

- Anti slip.
- Self Adhesive.
- Tear and wear resistant.
- Absorbent.
- Impact resistant.
- It is liquid proof.
- White.
- Easily applied.
- Due to its adhesive, it does not fly away from the wind and remains stuck to the surface.
- It is easily collected at the end of the job and does not leave any traces.



Code	Width	Length	Weight	Box
Super Adhesive Leakproof Floor Protection Sheet				
7100	3,2' / 1 m	164' / 50 m	160 gr/m <sup>2</sup>	1
Super Adhesive Leakproof Floor Protection Sheet				
7103	3,2' / 1 m	82' / 25 m	120 gr/m <sup>2</sup>	1
Super Adhesive Leakproof Floor Protection Sheet (Breathable)				
7107	3,2' / 1 m	82' / 25 m	120 gr/m <sup>2</sup>	1

# COMPOSITE POLES

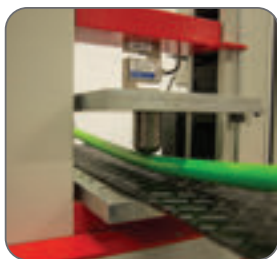

Our composite poles are made from a special mix of plastic and sheet metal.



Lightweight, corrosion resistant and bend resistant, it is ideal for reaching high surfaces in a controlled manner.



The universal end is compatible with many apparatuses.



It provides ease of purchase and sales with its economical price.

## Adjustable Composite Pole

2 Stage Composite Extension Pole

Code	max (m)	min (cm)	Stage	Box
1360	1	63	2	12
1361	1,5	87	2	12
1362	2	112	2	12
1363	2,5	140	2	12
1364	3	164	2	12



## Composite Fixed Poles

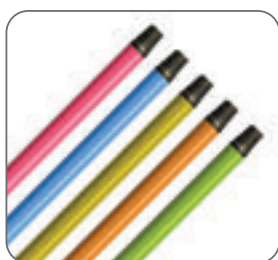

With its five different color options in its box, it provides choice according to the taste of the customer.

Code	Length (m)	Box
1365	1,2	25
1366	1,5	25
1367	1,8	25
1368	2	25



It can also be used as a display stand for its sale, with the apparatus which comes with its box and with its easy opening cap.

## Extreme Composite Pole



Can be used with 30, 40, 50, 60 cm plastic brushes.

Code	Length (m)	Box
1372	1,5	12

## Premium Composite Pole



Code	Length (m)	Box
2365	1,2	36

# EXTENSION POLES

Available in both light and thick options, these poles are built for strength and maneuverability. Choose from 2-stage or 3-stage versions for adjustable reach.



Light Aluminium Pole (Stable)

Code	Max (m)	Min (cm)	Stage	Box
1276	1,2	-	-	25
1277	1,5	-	-	25
1278	1,75	-	-	25
1279	2	-	-	25



2 Stage Light Aluminium Extension Pole

Code	Max (m)	Min (cm)	Stage	Box
1291	1,5	88	2	12
1292	2	113	2	12
1293	2,5	138	2	12
1294	3	163	2	12



3 Stage Light Aluminium Extension Pole

Code	Max (m)	Min (cm)	Stage	Box
1295	2	86	3	8
1296	4	148	3	8
1297	6	217	3	6
1299	8	417	3	4



2 Stage Light Aluminium Slender Extension Pole

Code	Max (m)	Min (cm)	Stage	Box
1280	1,5	88	2	12
1281	2	112	2	12
1282	2,5	138	2	12
1283	3	163	2	12



2 Stage Aluminium Thick Extension Pole

Code	Max (m)	Min (cm)	Stage	Box
1170	1,5	89	2	8
1171	2	114	2	8
1172	2,5	139	2	8
1173	3	165	2	8
1174	4	216	2	6
1176	5	265	2	6
1175	6	316	2	6



3 Stage Aluminium Thick Extension Pole

Code	Max (m)	Min (cm)	Stage	Box
1270	2	83	3	8
1271	2,5	103	3	8
1272	3	117	3	8
1273	4	150	3	8
1274	5	184	3	6
1275	6	217	3	6



Wood-Tipped Composite Pole

Versatile and durable, our wood-tipped poles are compatible with a wide range of tools and allow secure, multi-purpose use.

Code	Max (m)	Min (cm)	Stage	Box
1370	1,5	-	-	12

Can be used with Sweeping Brushes and 11,8" / 30 cm Scraper.



Travel Extension Pole

Code	Max (m)	Min (cm)	Stage	Box
1178	1,4	60	3	8



Extension Pole Adaptor

Code	Box
9954	25

We also offer pole adapters and specialized tips to ensure compatibility with scrapers, sweepers, and brushes for flexible operation.

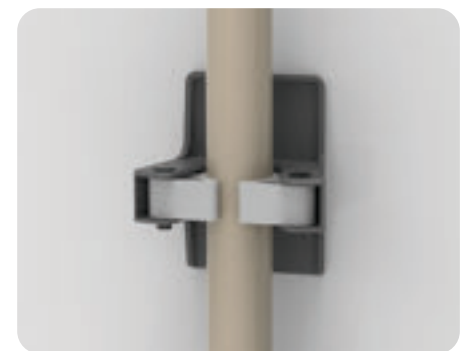

NEW

Broom Holder

Code	Dimensions
7200	7,8 x 8,3 x 4,6 cm 24 in a box

# WOODEN YARD BRUSHES



It has a hard fiber bristles.  
Used for sweeping hard objects.  
Long lasting wooden brush.  
Suitable for wet and dry surfaces.  
Use for household or industrial applications.

Hard fiber bristles makes it easy to sweep hard debris and garbage in such as areas of constructions, factories, parks, municipalities, airports and similar areas.

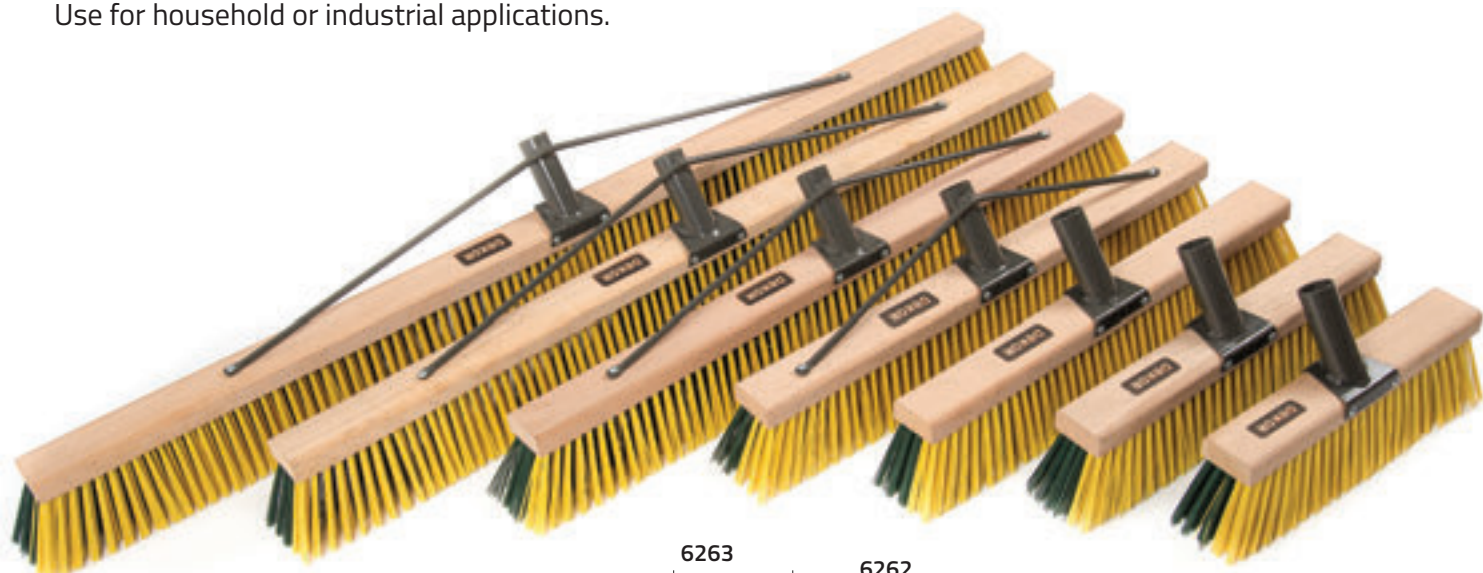

**6266**

47,2"
120 cm
2 in a box

**6265**

39,4"
100 cm
2 in a box

**6264**

31,5"
80 cm
6 in a box

**6263**

23,6"
60 cm
12 in a box

**6262**

19,7"
50 cm
12 in a box

**6261**

15,7"
40 cm
12 in a box

**6260**

11,8"
30 cm
12 in a box

Code	Width	Box
6260	11.8" / 30 cm	12
6261	15.7" / 40 cm	12
6262	19.7" / 50 cm	12
6263	23.6" / 60 cm	12
6264	31.5" / 80 cm	6
6265	39.4" / 100 cm	2
6266	47.2" / 120 cm	2



Use with  
Wood-Tipped  
Composite Pole.  
Page: 31

# STIFF BRISTLE BRUSHES

DEKOR.



This brush is used for sweeping hard objects. It has a plastic structure. Suitable for wet and dry surfaces. Use for household or industrial applications.

**NEW**  
**6313**  
 23,6" / 60 cm  
 12 in a box

**NEW**  
**6312**  
 19,7" / 50 cm  
 12 in a box

**NEW**  
**6311**  
 15,7" / 40 cm  
 12 in a box



**NEW**  
**6310**  
 11,8" / 30 cm  
 12 in a box

**NEW**  
 Use with Adjustable Extreme Composite Pole  
 Page: 30

Use with Adjustable Composite Pole  
 Page: 30

Use with Composite Fixed Pole (1365,1366)  
 Page: 30

Use with Light Aluminium Pole (Stable).  
 Page: 31

Code	Width	Box
6310	11.8" / 30 cm	12
6311	15.7" / 40 cm	12
6312	19.7" / 50 cm	12
6313	23.6" / 60 cm	12



**DEKOR.**

# DUAL FIBER BROOMS



The black hard bristles on the edges sweep the hard objects.



The blue soft bristles in the middle sweep the dust.

It has a hard and soft fiber bristle.  
 Used for sweeping hard objects.  
 Long lasting plastic brush.  
 Suitable for wet and dry surfaces.  
 Use for household or industrial applications.



**6308**

23,6" / 60 cm  
 12 in a box

**6305**

11,8" / 30 cm  
 12 in a box

**6307**

19,7" / 50 cm  
 12 in a box

**6306**

15,7" / 40 cm  
 12 in a box



Use with Adjustable Extreme Composite Pole  
 Page: 30

Use with Adjustable Composite Pole  
 Page: 30

Use with Composite Fixed Pole (1365, 1366)  
 Page: 30

Use with Light Aluminium Pole (Stable).  
 Page: 31

Code	Width	Box
6305	11.8" / 30 cm	12
6306	15.7" / 40 cm	12
6307	19.7" / 50 cm	12
6308	23.6" / 60 cm	12



# PLASTIC SWEEPING YARD BRUSHES

It has a hard fiber bristle.  
Used for sweeping hard objects.  
Long lasting plastic brush.  
Suitable for wet and dry surfaces.  
Use for household or industrial applications.



**6258**

23.6" / 60 cm  
12 in a box

**6257**

19.7" / 50 cm  
12 in a box

**6256**

15.7" / 40 cm  
12 in a box

**6255**

11.8" / 30 cm  
12 in a box



Use with  
Adjustable  
Extreme  
Composite Pole  
Page: 30

Use with  
Adjustable  
Composite Pole  
Page: 30

Use with  
Composite Fixed  
Pole (1365, 1366)  
Page: 30

Use with Light  
Aluminium Pole  
(Stable).  
Page: 31

Code	Width	Box
6255	11.8" / 30 cm	12
6256	15.7" / 40 cm	12
6257	19.7" / 50 cm	12
6258	23.6" / 60 cm	12





# PLASTIC SWEEPING BRUSHES

It has a soft fiber bristle.  
 Used for indoor and outdoor sweeping brush.  
 Long lasting plastic brush.  
 Suitable for wet and dry surfaces.  
 Use for household or industrial applications.



**6298**  
 23,6" / 60 cm  
 12 in a box

**6297**  
 19,7" / 50 cm  
 12 in a box

**6296**  
 15,7" / 40 cm  
 12 in a box

**6295**  
 11,8" / 30 cm  
 12 in a box



Use with Adjustable Extreme Composite Pole  
 Page: 30

Use with Adjustable Composite Pole  
 Page: 30

Use with Composite Fixed Pole (1365, 1366)  
 Page: 30

Use with Light Aluminium Pole (Stable).  
 Page: 31

Code	Width	Box
6295	11.8" / 30 cm	12
6296	15.7" / 40 cm	12
6297	19.7" / 50 cm	12
6298	23.6" / 60 cm	12



# AUTO & MARINE BRUSHES

Double Flow-Thru auto and marine wash brush. Long lasting plastic brush, not affected from hot water. Soft bristles make it safe for clear coat paint. Use for household or industrial applications with standard hose.

Double water flow-thru.



Auto Washing Brush

6220	10"
	25 cm
	12 in a box

Water flow-thru.



Marine Washing Brush

6231	13"
	33 cm
	4 in a box

Double water flow-thru.



Extra Auto Washing Brush

6221	10"
	25 cm
	12 in a box

Water flow-thru.



Extra Marine Washing Brush

6230	13"
	33 cm
	3 in a box



Premium Auto Washing Brush

6219	10"
	25 cm
	12 in a box



Easy on and off removable clamp. Special structure allows to water flow-thru.

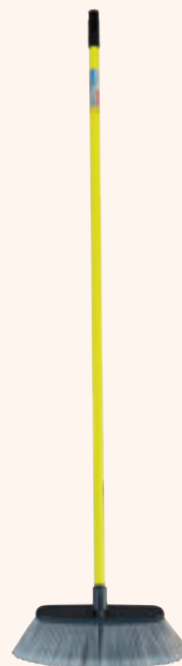

Wash Brush with Pole

6223	3,9 ft
	1,2 m
	36 in a box

Sale with wash brush.

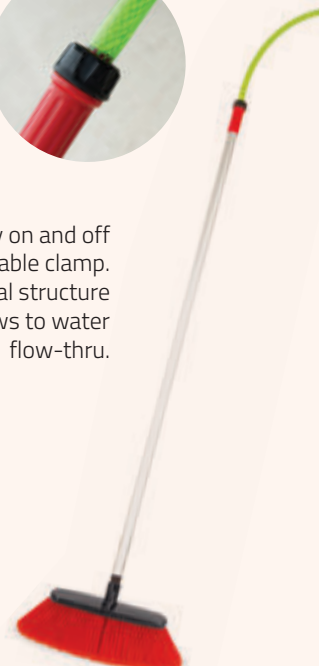

Flow-Thru Water Pole

1289	3,6 ft
	1,1 m
	12 in a box

Brush sold separately.

# SPECIALTY BRUSHES

Includes wire brushes, hand brushes, carpet scrubbers, and corner brushes — all engineered for specific cleaning tasks with ergonomic designs.



Water flow-thru.

For brushing the corners that are difficult to wipe.

Corner Scrub Brush

6270	9.4"
	24 cm
	2 in a box



For brushing the grounds.

Scrub Brush

6271	11.4"
	29 cm
	6 in a box



Double water flow-thru.

For removing stains on carpets.

Carpet Cleaning Brush

6240	9.4"
	24 cm
	12 in a box



Can be used both for general cleaning and as a squeegee.

Floor Scrub Brush

6241	10"
	25 cm
	12 in a box



For dust or for general cleaning.

Hand Brush

6280	5"
	13 cm
	12 in a box



For removing dirt from oily surfaces.

Soft Wire Brush

6200	5"
	13 cm
	12 in a box



For scrubbing rusty and abrasive surfaces.

Hard Wire Brush

6201	5"
	13 cm
	12 in a box

Code	Width	Box
6200	5" / 13 cm	12
6201	5" / 13 cm	12
6240	9.4" / 24 cm	12
6241	10" / 25 cm	12
6270	9.4" / 24 cm	2
6271	11.4" / 29 cm	6
6280	5" / 13 cm	12
6281	11.4" x 7" / 29 x 18 cm	12

## Dustpan and Brush Set 6281

12 in a box  
29 x 18 cm  
11.4" x 7"

Ideal for cleaning dirt in tight spaces and on various surfaces.



# MIXER HEADS



Available in SDS-Plus, M14, and hex shaft options, our epoxy mixers support up to 30 kg of material for seamless mixing of paints, plasters, and resins.



Up to **30** kilos.

✓ Mortar ✓ Plaster

Mortar Mixer Head

<b>1208</b>	Height: 23,2" / 59 cm
	6 in a box

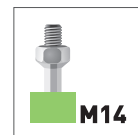

It only fits to drills with M14 bits.

Up to **30** kilos.

✓ Mortar ✓ Plaster

Mortar Mixer Head - M14

<b>1517</b>	Height: 23,2" / 59 cm
	6 in a box

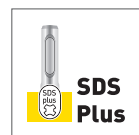

It only fits to drills with SDS Plus bits.

Up to **30** kilos.

✓ Mortar ✓ Plaster

Mortar Mixer Head - SDS Plus

<b>1518</b>	Height: 23,2" / 59 cm
	6 in a box



Up to **25** kilos.

✓ Mortar ✓ Paint ✓ Plaster

Mixer Head

<b>1514</b>	Height: 23,2" / 59 cm
	12 in a box



Up to **25** kilos.

✓ Mortar ✓ Paint ✓ Plaster

Mixer Head -SDS PLUS

<b>1714</b>	Height: 23,2" / 59 cm
	12 in a box

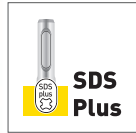

Up to **10** kilos.

✓ Mortar ✓ Paint ✓ Plaster

Mixer Head -SDS PLUS

<b>1715</b>	Height: 17,7" / 45 cm
	12 in a box

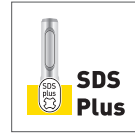

Up to **10** kilos.

✓ Mortar ✓ Paint ✓ Plaster

Mixer Head

<b>1515</b>	Height: 16,1" / 41 cm
	12 in a box



Up to **25** kilos.

✓ Mortar ✓ Paint ✓ Plaster

Mixer Head -SDS PLUS

<b>1519</b>	Height: 17,7" / 45 cm
	12 in a box



Up to **25** kilos.

✓ Mortar ✓ Paint ✓ Plaster

Mixer Head

<b>1209</b>	Height: 17,7" / 45 cm
	12 in a box



Up to **25** kilos.

✓ Mortar ✓ Paint ✓ Plaster

Butterfly Mixer Head

<b>1513</b>	Height: 18,5" / 47 cm
	12 in a box



Up to **25** kilos.

✓ Mortar ✓ Paint ✓ Plaster

Butterfly Mixer Head-SDS PLUS

<b>1713</b>	Height: 18,5" / 47 cm
	12 in a box





Up to **10** kilos.

✓ Paint ✓ Plaster

Mixer Head

**1512**

Height: 17,3" / 44 cm
12 in a box



Up to **15** kilos.

✓ Paint ✓ Plaster

Mixer Head

**1510**

Height: 17" / 43 cm
12 in a box



Up to **5** kilos.

✓ Mortar ✓ Paint ✓ Plaster

Mixer Head

**1516**

Height: 10" / 25 cm
12 in a box



Up to **15** kilos.

✓ Paint ✓ Plaster

Auger Mixer Head

**1511**

Height: 15" / 38 cm
12 in a box



Up to **25** kilos.

✓ Paint ✓ Plaster

Mixer Head

**1520**

Height: 10" / 25 cm
12 in a box

Code	Product	Head	Height	Diameter	Side	Mix (kg)	Power (w)	Box
1208	Mortar Mixer Head	Hexagon	23,2" / 59 cm	5,5" / 14 cm	0,5" / 12 mm	15 - 30	1000	6
1209	Mixer Head	Hexagon	17,7" / 45 cm	3,3" / 8,5 cm	0,4" / 10 mm	10 - 25	600	12
1510	Mixer Head	Hexagon	17" / 43 cm	2,6" / 6,5 cm	0,3" / 8 mm	5 - 15	500	12
1511	Auger Mixer Head	Hexagon	15" / 38 cm	1,6" / 4 cm	0,4" / 10 mm	0-15	1000	12
1512	Mixer Head	Hexagon	17,3" / 44 cm	3,1" / 8 cm	0,3" / 8 mm	10	500	12
1513	Butterfly Mixer Head	Hexagon	18,5" / 47 cm	3,5" / 9 cm	0,4" / 10 mm	25	600	12
1514	Mixer Head	Hexagon	23,2" / 59 cm	3,5" / 9 cm	0,4" / 10 mm	10 - 25	700	12
1515	Mixer Head	Hexagon	16,1" / 41 cm	2,4" / 6 cm	0,3" / 8 mm	5 - 10	500	12
1516	Mixer Head	Circle	10" / 25 cm	1,6" / 4 cm	0,2" / 6 mm	0 - 5	500	12
1517	Mortar Mixer Head	M14	23,2" / 59 cm	5,5" / 14 cm	0,6" / 14 mm	15 - 30	1000	6
1518	Mortar Mixer Head	SDS Plus	23,2" / 59 cm	5,5" / 14 cm	0,6" / 14 mm	15 - 30	1000	6
1519	Mixer Head	SDS Plus	17,7" / 45 cm	3,3" / 8,5 cm	0,4" / 10 mm	10 - 25	600	12
1520	Mixer Head	Circle	10" / 25 cm	2,4" / 6 cm	0,2" / 6 mm	25	600	12
1713	Butterfly Mixer Head	SDS Plus	18,5" / 47 cm	3,5" / 9 cm	0,4" / 10 mm	25	600	12
1714	Mixer Head	SDS Plus	23,2" / 59 cm	3,5" / 9 cm	0,5" / 12 mm	10 - 25	700	12
1715	Mixer Head	SDS Plus	17,7" / 45 cm	2,4" / 6 cm	0,4" / 10 mm	5 - 10	500	12

# EPOXY ACCESSORIES

It is used for Extracting air bubbles in epoxy chemicals.



**Adjustable Paint Roller Handle**

**9099**

2,2" x 13,2" x 5"  
5,7 x 33,5 x 12,7 cm  
2 in a box

It can be used with 30, 40, 50, 60 cm Epoxy Spiked Rollers (Small diameter)



Epoxy Spiked Roller (Large)

<b>1223</b>	20 cm
	2 in a box

Epoxy Spiked Roller (Small)

<b>1226</b>	4" / 10 cm
	2 in a box

Epoxy Spiked Roller (Small)

<b>1220</b>	8" / 20 cm
	2 in a box



**NEW**

**NEW**

Epoxy Spiked Roller (Small)

<b>1193</b>	23,6 / 60 cm
	2 in a box

Epoxy Spiked Roller (Large)

<b>1196</b>	23,6 / 60 cm
	2 in a box



Wearable protective soles designed for walking on wet epoxy without disturbing surface finish.

Epoxy Nailed Shoes

<b>1126</b>	12,2" / 31 cm
	1 pair

Code	Length	Diameter	Box
------	--------	----------	-----

Epoxy Spiked Roller (Small)

1226	4" / 10 cm	2,8" / 7 cm	2
1220	8" / 20 cm	2,8" / 7 cm	2
1221	10" / 25 cm	2,8" / 7 cm	2
1222	11,8" / 30cm	2,8" / 7 cm	2
1191	15,7 / 40 cm	2,8" / 7 cm	2
1192	19,7 / 50 cm	2,8" / 7 cm	2
1193	23,6 / 60 cm	2,8" / 7 cm	2

Epoxy Spiked Roller (Large)

1223	8" / 20 cm	4,3" / 11 cm	2
1224	10" / 25 cm	4,3" / 11 cm	2
1225	11,8" / 30cm	4,3" / 11 cm	2
1194	15,7 / 40 cm	4,3" / 11 cm	2
1195	19,7 / 50 cm	4,3" / 11 cm	2
1196	23,6 / 60 cm	4,3" / 11 cm	2

Code	Length	Box
------	--------	-----

Epoxy Nailed Shoes

1126	12,2" / 31 cm	1
------	---------------	---

Adjustable Epoxy Stage Trowel

1140	27,6" / 70 cm	6
------	---------------	---

Epoxy Stage Trowel

1127	19,7" / 50 cm	1
------	---------------	---

Hot Isolation Roller

1034	8" / 20 cm	12
------	------------	----



**Hot Isolation Roller**

Built for precision and heat resistance.

<b>1034</b>	8" / 20 cm
	12 in a box

Adjustable Epoxy Stage Trowel

<b>1140</b>	27,6" / 70 cm
	6 in a box



**Epoxy Stage Trowel**

**1127**  
1 in a box  
19,7" / 50 cm



Used for spreading epoxy and chemical resins. Level height can be adjusted by means of screws on the top.

## Aluminium Crushing Roller



1160

1161

Used to remove trapped air between fiberglass layers in polyester applications.

Code	Length	Ø	Box
1160	3,1" / 8 cm	0,8" / 2 cm	25
1161	5,1" / 13 cm	0,8" / 2 cm	25

Sleeves

1162	3,1" / 8 cm	0,8" / 2 cm	25
1163	5,1" / 13 cm	0,8" / 2 cm	25

## Wallpaper Seam Roller

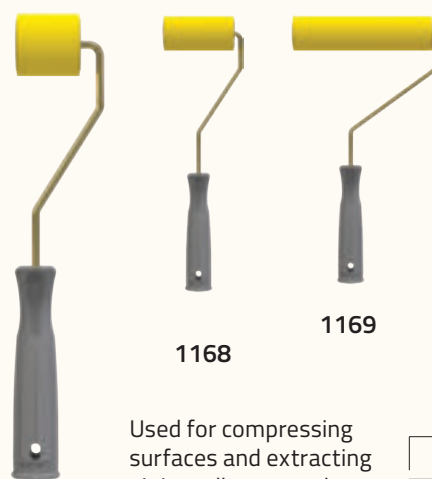

1168

1169

1167

Used for compressing surfaces and extracting air in wallpaper and resin work.

Code	Length	Box
1167	1,8" × 1,8" / 4,5 × 4,5 cm	6
1168	3,5" × 1,8" / 9 × 4,5 cm	6
1169	7" × 1,8" / 18 × 4,5 cm	6



**DEKOR.**



Premium Metal Squeegee  
**2250**

60 cm  
12 in a box

**NEW**



**NEW**

Premium Squeegee  
**1411**

40 cm  
12 in a box



Rubber Squeegee with Plastic Frame  
**1210**

42,5 cm  
12 in a box

**NEW**

Code	Length	Box
Rubber Squeegee with Plastic Frame		
1210	16,7" / 42,5 cm	12
1410	20,7" / 52,5 cm	12
1411	15,7" / 40 cm	12

**NEW**

**NEW**

**NEW**

Code	Length	Box
Premium Metal Squeegee		
2248	11,8" / 30 cm	12
2249	15,7" / 40 cm	12
2250	23,6" / 60 cm	12

## BOAT HOOK

It is used for helping boats and rowboats to come abroad and it is also used for them to pull rope.

1284

Code	Max (ft / m)	Min (inch / cm)	Box
Boat Hook (Stabile)			
1284	4,92 / 1,5	-	6
Adjustable Boat Hook			
1285	4,92 / 1,5	39,4 / 100	6
1286	6,56 / 2	47,2 / 120	6
1287	8,20 / 2,5	57,7 / 144	6
1288	9,84 / 3	67,3 / 171	6

1288

1287

1286

1285

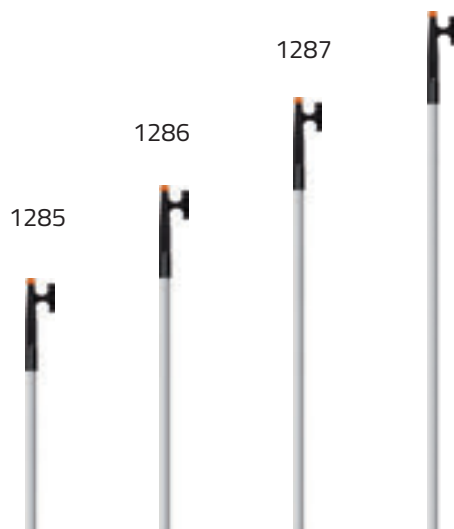

# SCRAPERS

Our range of scrapers — including wood handle, aluminium grip, triangular, and mini scrapers — provides reliable tools for removing paint, glue, and debris from all surfaces.

Aluminium Scraper

<b>1529</b>	1,77" × 10,6"
	4,5 × 27 cm
	12 in a box



Aluminium Scraper

<b>1531</b>	1,8" × 43,3"
	4,5 × 110 cm
	6 in a box



Aluminium Grip Scraper

<b>1532</b>	2,8" × 11,4"
	7 × 29 cm
	12 in a box

Aluminium Scraper Spare

**5102**  
0,9" × 2,8"  
2,2 × 7 cm  
25 in a box



Aluminium Scraper Spare (for 1529 and 1531)

**5103**  
0,9" × 1,8"  
2,2 × 4,5 cm  
25 in a box



For use in various scraping works. Adjustable handle eases usage in wide area applications.



Used for scraping in narrow and hard-to-reach areas that require scraping, such as boats, yachts, and parquet surfaces.

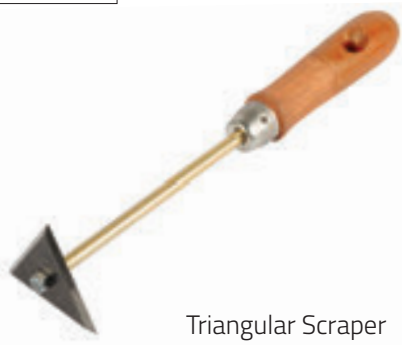

Triangular Scraper

<b>1211</b>	2,4" × 11,8"
	6 × 30 cm
	12 in a box

Spare Knife for Triangular Scraper

**5101**  
2,4"  
6 cm  
12 in a box



Wood Handle Scraper

<b>1204</b>	2,4" × 10,6"
	6 × 27 cm
	12 in a box

Spare Knife for Wood Handle Scraper

**5100**  
2" × 2,4"  
5x6 cm  
25 in a box



Code	Dimensions (cm)	Box
1204	6 x 27	12
1211	6 x 30	12
1529	4,5 x 27	12
1531	4,5 x 110	6
1532	7 x 29	12
7002	4 x 5,8	24

Spares

5100	5 x 6	25
5101	6,6 x 5,6	12
5102	2,2 x 7	25
5103	2,2 x 4,5	25

Mini Scraper

**7002**  
1,6" × 2,3"  
4 × 5,8 cm  
20 in package  
24 in a box



It removes paint stains, adhesives, wax, oil, and grime from surfaces like granite, stovetops, and glass.





Scraper with Composite Handle

<b>2225</b>	11,8" × 55,1"
	30 × 136 cm
	6 in a box



Scraper with Composite Handle

<b>2223</b>	8" × 53,1"
	20 × 136 cm
	6 in a box



Scraper

<b>2201</b>	2" × 8"
	5 × 20 cm
	6 in a box



**1,5"/37mm diameter**

**1,1"/28mm diameter**

Scraper

<b>2205</b>	11,8" × 9,8"
	30 × 25 cm
	6 in a box

Scraper

<b>2204</b>	11,8" × 10"
	30 × 25 cm
	6 in a box



Scraper

<b>2202</b>	4" × 8"
	10 × 20 cm
	6 in a box

Scraper

<b>2203</b>	8" × 8,3"
	20 × 21 cm
	6 in a box

### Scraper with Blast Pipe 1301

5" × 39,4"  
13 × 100 cm

Used for removing paints by fire with LPG tube. It is scraping with 5,1" / 13 cm wide scraper mouth.

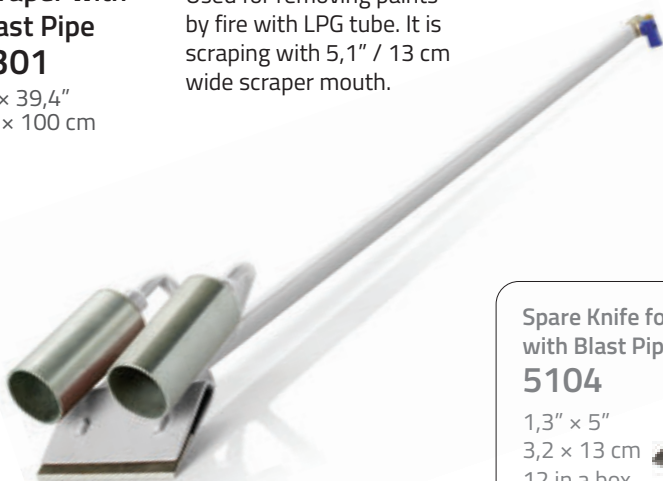

### Spare Knife for Scraper with Blast Pipe 5104

1,3" × 5"  
3,2 × 13 cm  
12 in a box



Code	Dimensions (cm)	Box
2201	5 × 20	6
2202	10 × 20	6
2203	20 × 21	6
2204	30 × 25	6
2205	30 × 25	6
2223	20 × 136	6
2225	30 × 136	6

### Scraper with Blast Pipe

1301	13 × 100	1
------	----------	---

### Spare Knife for Scraper with Blast Pipe

5104	3,2 × 13	12
------	----------	----

# SANDERS

Designed for wall and surface sanding, our ergonomic sanders include pole and hand versions that allow comfort and control even in tight corners.



Pole Hand Sander

<b>1507</b>	4,5" × 9"
	11,5 / 23 cm
	12 in a box



Pole Hand Sander

<b>1207</b>	3,5" × 8,9"
	9 × 22,5 cm
	12 in a box



Hand Sander

<b>1206</b>	3,5" × 8,9"
	9 × 22,5 cm
	12 in a box

Rubber Hand Sander

<b>1234</b>	2,8" × 8,3"
	7 × 21 cm
	12 in a box

Used in surface sanding applications.



Ergonomic Hand Sander

<b>1235</b>	6" / 15 cm
	12 in a box

Used in surface sanding applications. Easy use due to the ergonomic structure facilitating gripping and applying power. Can be used with both the right and left hand.



Code	Dimensions	Box
1206	3,5" × 8,9" / 9 × 22,5 cm	12
1207	3,5" × 8,9" / 9 × 22,5 cm	12
1507	4,5" × 9" / 11,5 × 23 cm	12
1234	2,8" × 8,3" / 7 × 21 cm	12
1235	6" / 15 cm	12

Strip Disc Tool

1380	1,8" / 4,5 cm	12
1381	2" / 5 cm	12

Strip Disc Foam

1382	1,8" / 4,5 cm	25
1383	2" / 5 cm	25



Strip Disc Tool

<b>1380</b>	1,8" / 4,5 cm
	12 in a box

Used for polishing chrome surfaces.



Strip Disc Foam

<b>1382</b>	1,8" / 4,5 cm
	25 in a box

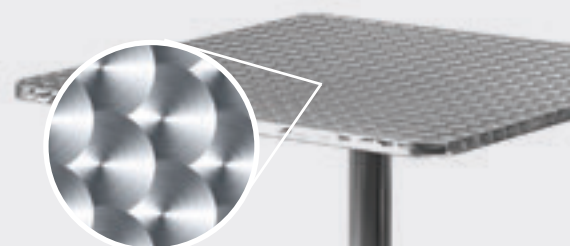

# TROWELS



Used for plaster applications on interior surfaces. Produced from acrylic plate and it has plastic handle.



For use in Exterior plaster applications. It is produced from acrylic plate.

Plastic Trowel

<b>1187</b>	5" x 11"
	12,8 x 28 cm
	12 in a box

Silk Plastic Trowel

<b>073</b>	4" x 11"
	10 x 28 cm
	12 in a box



Used for the smoothing corners.

Stainless Steel  
Internal Corner Trowel

<b>1212</b>	12 in a box
-------------	-------------



Stainless Steel  
External Corner Trowel

<b>1213</b>	12 in a box
-------------	-------------

Code	Dimensions	Box
073	4" x 11" / 10 x 28 cm	12
1187	5" x 11" / 12,8 x 28 cm	12
1212	-	12
1213	-	12

# SPREADERS

It is used to form flat and smooth surfaces on the areas of application by means of its flexible and silicon structure. It eliminates air bubbles.



Spreader (Thin)  
**1231**  
4" / 10 cm  
24 in a box



Spreader  
**1350**  
2,2" / 5,5 cm  
24 in a box



Spreader  
**1351**  
2,8" / 7 cm  
24 in a box



Big Spreader  
(with handle)  
**1355**  
4,5" / 11,5 cm  
12 in a box

Spreader (with handle)  
**1353**  
2,2" / 5,5 cm  
12 in a box



Big Spreader  
(with handle)  
**1354**  
2,8" / 7 cm  
12 in a box



Code	Length	Box
1231	4" / 10 cm	24
1350	2,2" / 5,5 cm	24
1351	2,8" / 7 cm	24
1353	2,2" / 5,5 cm	12
1354	2,8" / 7 cm	12
1355	4,5" / 11,5 cm	12

**DEKOR.**



<b>1414</b>	13,8"
	35 cm
	6 in a box

<b>1415</b>	19,7"
	50 cm
	6 in a box

**Plastic Rake**

Used for spreading mortar, removing snow, spreading gravel, cleaning barns and many other applications.



**1370**

Use with Wood-Tipped Composite Pole (Stable)

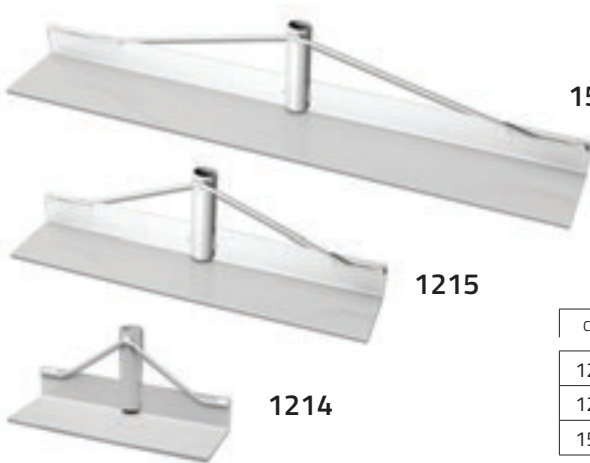

**1530**

**1215**

**1214**

**Mortar Rake**

Used for spreading and collecting mortar and similar materials.

Code	Length	Box
1214	4" x 11,8" / 10 x 30 cm	6
1215	4" x 19,7" / 10 x 50 cm	6
1530	4" x 31,5" / 10 x 80 cm	6

Use with Wood-Tipped Composite Pole (Stable)



<b>1370</b>	4,92 ft
	1,5 m
	12 in a box



**Aluminium Plaster Feather Edge**

Used for plaster gauging. It is made of Aluminium and produced in three types for interior, Exterior and purposes. There is different lengths 39,4" / 1 m to 19,68 ft / 6 m.

Code	Type	Height (m)	Width (cm)	Thickness (mm)
1198	Standard	1	11	1,8
1709	Standard	1,5	11	1,8
1710	Standard	2	11	1,8
1711	Standard	2,5	11	1,8
1712	Standard	3	11	1,8
1199	Inner	1	9,8	1,5
1701	Inner	1,5	9,8	1,5
1702	Inner	2	9,8	1,5
1703	Inner	2,5	9,8	1,5
1704	Inner	3	9,8	1,5
1200	Outter	1	11,3	1,5
1705	Outter	1,5	11,3	1,5
1706	Outter	2	11,3	1,5
1707	Outter	2,5	11,3	1,5
1708	Outter	3	11,3	1,5

- Code: 1198 Standard
- Code: 1199 Inner
- Code: 1200 Outter



**1198**

**1199**

**1200**

# AERATED CONCRETE PRODUCTS

DEKOR.

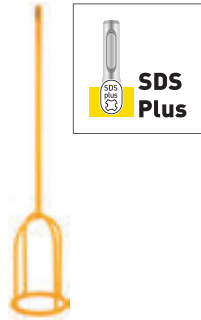

Aerated Concrete Mixer Head

<b>1522</b>	H: 21,7" D: 4,2"
	H: 55 cm D: 10,7 cm
	6 in a box



Aerated Miter

<b>2543</b>	10,2"
	26 cm
	6 in a box



Aerated Concrete Shovel  
**2544**  
3,3"  
8,5 cm  
2 in a box

Code	Lenght	Box
Aerated Concrete Shoveller		
2544	3,3" / 8,5 cm	2
2545	4,1" / 10,5 cm	2
2546	5,3" / 13,5 cm	2
2547	6,1" / 15,5 cm	2
2548	8" / 20,5 cm	2
2549	10" / 25,5 cm	2



Aerated Concrete Trencher

<b>2550</b>	17,7" / 45 cm
	4 in a box

! All size included

Code	Lenght	Box
1522	21,7" / 55 cm	6
2540	4,9" / 12,5 cm	12
2541	14,2" / 36 cm	6
2542	14,2" / 36 cm	6
2543	10,2" / 26 cm	6
2550	17,7" / 45 cm	4

**Punches** are used by using low speed drills without giving harm to the electrical installation.

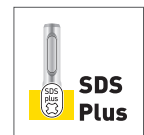

Aerated Concrete Electric Box Opener

<b>2540</b>	2,6" x 4,9"
	6,5 x 12,5 cm
	12 in a box



Aerated Concrete Aspirator Chimney Punch

<b>2541</b>	5,3" x 14,2
	13,5 x 36 cm
	6 in a box



Aerated Concrete Boiler Chimney Punch

<b>2542</b>	4,5" x 14,2"
	11,5 x 36 cm
	6 in a box

# DEKORATIVE FOAM PAINT ROLLER

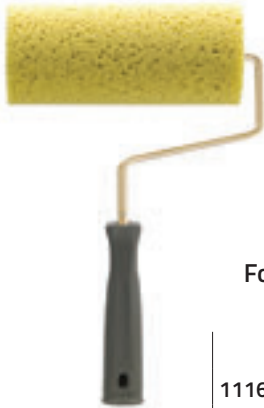

**Foam Coral Roller**

<b>1116</b>	8"
	20 cm
	12 in a box

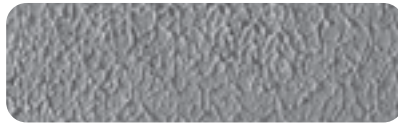

**Foam Roller with Cavities**

<b>1117</b>	8"
	20 cm
	12 in a box



**Foam Roller with Naps**

<b>1118</b>	8"
	20 cm
	12 in a box

Code	Length	Box
<b>Foam Coral Roller</b>		
1116	8" / 20 cm	12
<b>Foam Coral Roller Sleeve</b>		
1136	8" / 20 cm	25
<b>Foam Roller with Cavities</b>		
1117	8" / 20 cm	12
1129	10" / 25 cm	12
<b>Foam Roller with Cavities Sleeve</b>		
1135	10" / 25 cm	25
<b>Foam Roller with Naps</b>		
1156	19,7" / 50 cm	4
1155	15,7" / 40 cm	4
1154	11,8" / 30 cm	4
1122	10" / 25 cm	12
1118	8" / 20 cm	12
<b>Foam Roller with Naps Sleeve</b>		
1159	19,7" / 50 cm	9
1158	15,7" / 40 cm	9
1157	11,8" / 30 cm	9
1125	10" / 25 cm	25
1124	8" / 20 cm	25
<b>Foam Radiator Roller with Naps</b>		
1123	4" / 10 cm	25
<b>Foam Radiator Roller with Naps Sleeve</b>		
1128	4" / 10 cm	50

Used with acrylic paints on Exterior for decorative purposes.



**Foam Roller with Naps**

<b>1156</b>	19,7"
	50 cm
	4 in a box



**Foam Radiator Roller with Naps**

<b>1123</b>	4"
	10 cm
	25 in a box

# DECORATIVE PAINTING ROLLERS

DEKOR.

For use in decorative paint applications to create figures and patterns on wall and ceiling. Must be applied with special effect roller.



**Ringed Roller**

1550	4,3"
	11 cm
	2 in a box

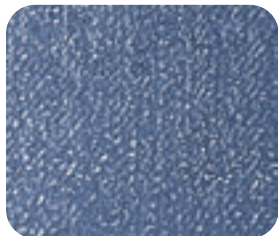

**Leather Rose  
Effect Roller**

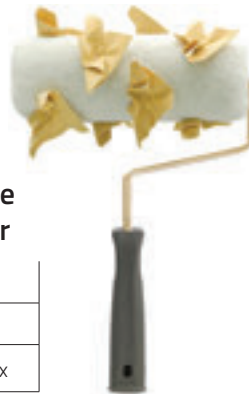

1321	8"
	20 cm
	2 in a box



**Thin Effect  
Roller**

1346	8"
	20 cm
	2 in a box

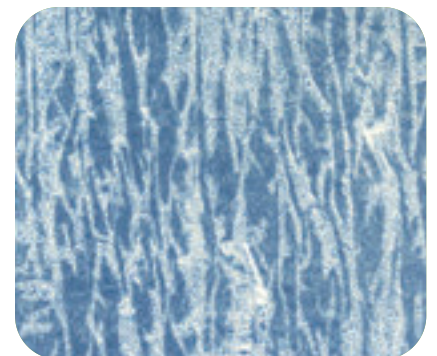

**Nylon Effect  
Roller**

1323	8"
	20 cm
	2 in a box



**Leather Effect  
Roller**

1320	8"
	20 cm
	2 in a box

Code	Length	Box
1320	8" / 20 cm	2
1321	8" / 20 cm	2
1323	8" / 20 cm	2
1346	8" / 20 cm	2
1550	4,3" / 11 cm	2

# DECORATIVE PAINTING TOOLS

For use in decorative paint applications to create figures and patterns on wall and ceiling. Must be applied with special effect roller.

① USED WITH SPECIAL EFFECT PAINT.

**Leather Rose Effect Tool**  
1326 / 6" x 2,4" / 15 x 6 cm / 3 in a box



**Deep Relief Sponge**  
1327 / 6" / 15 cm / 4 in a box



**Crystal Effect Sponge**  
1328 / 6" / 15 cm / 4 in a box



**9 Stamp Effect Tool**  
1425 / 5,5" x 5,5" / 14 x 14 cm / 2 in a box



**13 Stamp Effect Tool**  
1325 / 5,5" x 5,5" / 14 x 14 cm / 2 in a box

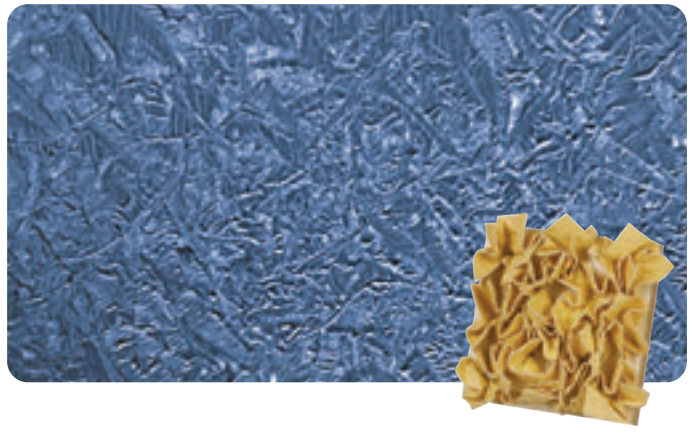

**25 Stamp Effect Tool**  
1341 / 8,7" x 8,7" / 22 x 22 cm / 2 in a box

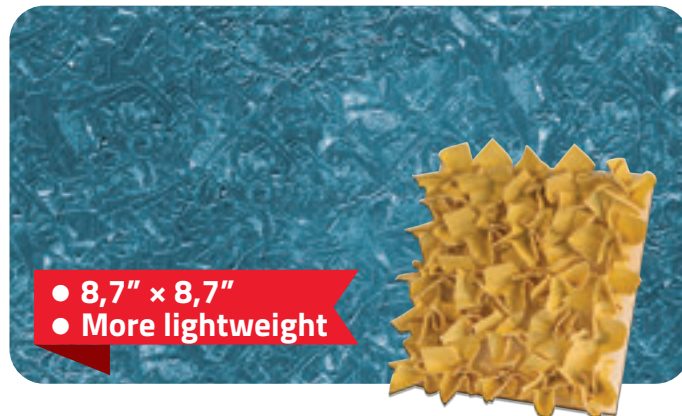

**36 Stamp Effect Tool**  
1342 / 10" x 10" / 25 x 25 cm / 2 in a box

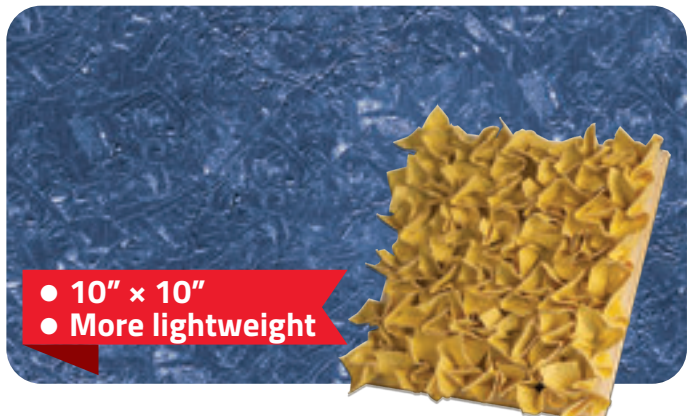



**1344**  
8" / 20 cm  
2 in a box

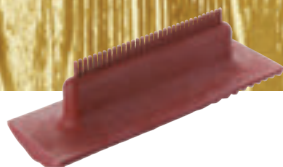

**1347**  
6" / 15 cm  
6 in a box



**1345**  
4" / 10 cm  
6 in a box

**Wood Surface Effect Tool**

Code	Length	Box
1344	8" / 20 cm	2
1347	6" / 15 cm	6
1345	4" / 10 cm	6



**Effect Spatula**  
1555 / 4,1" x 6,3"  
/ 10,5 x 16 cm / 6 in a box

# EFFECT SERIES

## APPLICATION

⚠ For having clear figure use effect paint.

MATERIALS REQUIRED

Paint and application for painting background.



Sponge and water for making wet the background.



Effect paint and roller to apply effect for second layer.



Sponge roller for removing the excess of paint.



The tool for the effect to be applied.



**1**  
Please apply lining paint and wait until it is dry. For not drying up effect paint, wet gently over the lining paint.

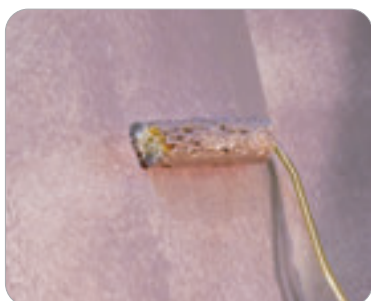

**2**  
Apply the effect paint on the lining. Remove the excessive of paint by using sponge roller.



**3**  
Before the effect paint dry using effect tool you can make figure by pressing the tool on the wall.



First and second layer of paint will appear final touch over your wall. Keep this in mind when choosing colors for each floor. Effects may vary depending on the applied techniques and paint. Before application a good idea to create a test area to experiment.

# PAINTING MACHINES



**Whitewash Tank**

<b>1300</b>	1305 + 1310 + 19,69 ft / 10 m hose
	1 Box

Used in limewash applications. Tank with a storage of 5 tins of limewash operates with 4 bar pressures. It requires air-compressor connection.

Code	Product	Box
1300	Machine Set	1
1305	Whitewash Tank	1
1310	Whitewash Head	1



1302	Machine Set	1
1303	Tank 10,6 gal. / 40 Lt	1
1304	Spraying Gun	1
1311	Spray Nozzle of Gun	1



**Interior Decorate  
Spraying Machine**

<b>1302</b>	1303 + 1304 + 19,69 ft / 10 m hose
	1 Box

Used for internal facade coating or applying the face rite paint on plaster, concrete, gauging plaster, wooden Natural boards and prefabricated surfaces in interior decorations. Creates large and small grains on walls. Requires a set with a 32,8 ft hose and a 10,6 gal. storage tank, and 5 bar compressor connection. Size of the grains can be adjusted using the pressure and paint adjustment valves on the gun.

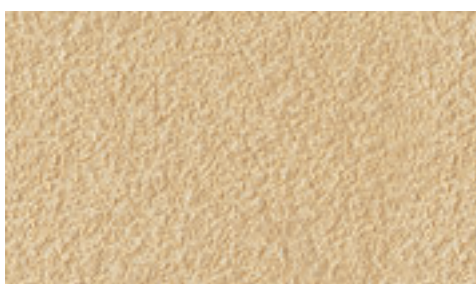

1306	Complete Set	1
1307	Spraying Gun	1
1308	Tank 0,52 gal. / 2 lt	1



**Exterior Surface Acrylic  
Spraying Gun**

<b>1306</b>	1307 + 1308
	1 Box

Used in External decoration applications with paint gun with acrylic External mineral-sanded coating paints. The gun operating with 5-7 bar pressure requires a compressor connection. The gun creates large and small grains on walls. Grain size is adjusted using pressure adjustment screw at the backside of the gun.

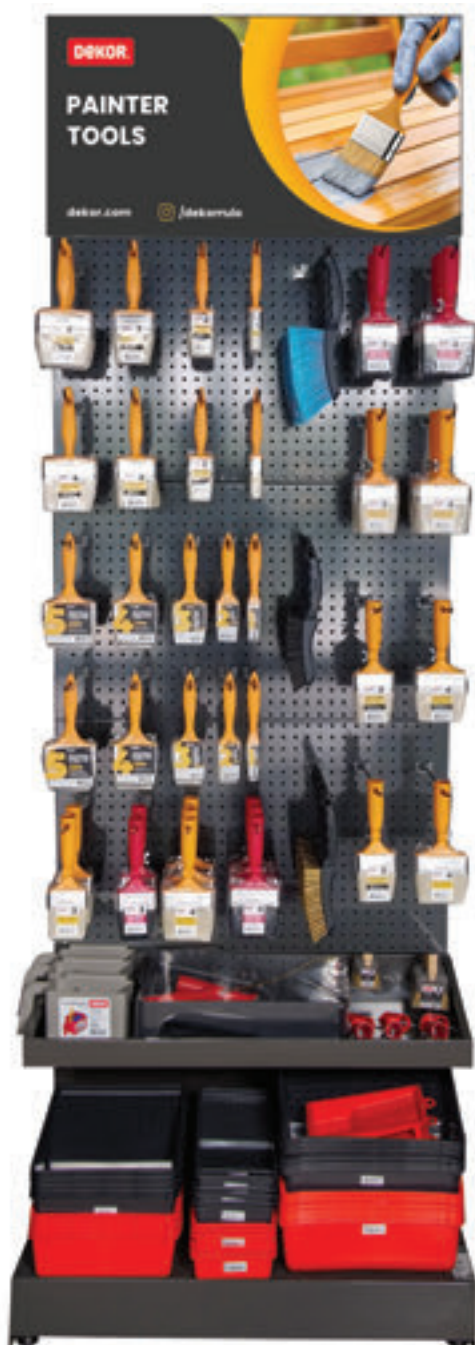

## PAINT BRUSH STAND

<b>9125</b>
Height: 7,87 ft / 2,4 m
Width: 31,5" / 80 cm
Depth: 21,3" / 54 cm
2 Box + 1 Link
Total 245 product



## PAINTER STAND

<b>9121</b>
Height: 7,87 ft / 2,4 m
Width: 31,5" / 80 cm
Depth: 21,3" / 54 cm
3 Box + 1 Link
Total 155 product



**PAINT AND  
HARDWARE  
STAND**

<b>9118</b>
Height: 7,87 ft / 2,4 m
Width: 39,4" / 100 cm
Depth: 21,3" / 54 cm
3 Box + 2 Link
Total 174 product



**20 CM  
ROLLER  
STAND**

<b>9122</b>
Height: 7,87 ft / 2,4 m
Width: 15,7" / 40 cm
Depth: 21,3" / 54 cm
2 Box + 1 Link
Total 74 product



## 25 CM ROLLER STAND

<b>9123</b>
Height: 6,56 ft / 2 m
Width: 15,7" / 40 cm
Depth: 21,3" / 54 cm
2 Box + 1 Link
Total 74 product



## POINT STAND

<b>9124</b>
Height: 6,56 ft / 2 m
Width: 23,6" / 60 cm
Depth: 17,3" / 44 cm
3 Box + 1 Link
Total 132 product



## MIXER STAND

**9134**

Height: 7,87 ft / 2,4 m

Width: 15,7" / 40 cm

Depth: 21,3" / 54 cm

2 Box + 1 Link

Total 47 product



## EPOXY STAND

**9131**

Height: 7,87 ft / 2,4 m

Width: 15,7" / 40 cm

Depth: 21,3" / 54 cm

2 Box + 1 Link

Total 26 product

## POLE STAND

**9135**

Height: 25,6" / 65 cm

Width: 18,1" / 46 cm

Depth: 15,7" / 40 cm

1 Box + 4 Link

Total 48 product





## SCRAPER STAND

<b>9129</b>
Height: 7,87 ft / 2,4 m
Width: 31,5" / 80 cm
Depth: 21,3" / 54 cm
2 Box + 2 Link
Total 110 product



## CLEANING STAND

<b>9132</b>
Height: 7,87 ft / 2,4 m
Width: 31,5" / 80 cm
Depth: 21,3" / 54 cm
2 Box + 2 Link
Total 64 product



## MARINE STAND

**9128**

Height: 7,87 ft / 2,4 m

Width: 31,5" / 80 cm

Depth: 21,3" / 54 cm

2 Box + 2 Link

Total 105 product



## **AUTOCLAVED AERATED CONCRETE PRODUCT STAND**

<b>9133</b>
Height: 7,87 ft / 2,4 m
Width: 15,7" / 40 cm
Depth: 21,3" / 54 cm
2 Box + 1 Link
Total 32 product

# DEKOR DISPLAY CONCEPT

## 9100

Height: 7,87 ft / 2,4 m

Width: 29,53 ft / 9 m

Depth: 21,3" / 54 cm

Total 1574 product

9113

9101

9102

9103

9104

1300

39,4" / 100 cm

53,1" / 135 cm



9114

9106

9107

9110

9111

9112

1302

Dekor Display Concept includes 1574 items in different sizes and models. The range consisting of 9 vertical boards 2 paned rod rails covers almost all Dekor products. Dealers having this exhibition range in their stores will support the sales in their region by enriching the product content. Moreover; product demands received from the regions in our company will be directed to the dealers having this range in their stores and they will also benefit. Exhibition range can be either used in whole or distributed in the store depending on the panel ranges. Prices of this Exhibition range are determined depending on the list prices of the products it covers.

# Dekor Display Concept

Code Product Unit

## 9101 243 product Interior Painting Application

1017	Plasdek Roller 10" / 25 cm	12
1015	Plasdek Roller 8" / 20 cm	8
1081	Eksport Roller 10" / 25 cm	12
1080	Eksport Roller 20 cm	8
1064	Varnish & Oil Paints Roller 10" / 25 cm	8
1065	Varnish & Oil Paints Roller 8" / 20 cm	8
1035	Sheepskin Roller 8" / 20 cm	3
1084	Eksport Radiator Roller 4" / 10 cm	6
6170	Water-Based Paint Brush 1" / 24 mm (New)	2
6172	Water-Based Paint Brush 1,7" / 44 mm (New)	2
6174	Water-Based Paint Brush 2,5" / 64 mm (New)	2
6175	Water-Based Paint Brush 3,3" / 84 mm (New)	2
6176	Water-Based Paint Brush 4" / 100 mm (New)	2
6470	Premium Water-Based Brush 1" / 25 mm (New)	4
6472	Premium Water-Based Brush 2" / 50 mm (New)	4
6474	Premium Water-Based Brush 3" / 76 mm (New)	4
6475	Premium Oil Paint Robot Brush 4"/100 mm	4
1100	Eksport Radiator Roller Sleeve 4" / 10 cm	50
3100	Eksport Radiator Roller Sleeve 3 in a package 4" / 10 cm	24
2100	Eksport Radiator Roller Sleeve 12 in a package 4" / 10 cm	2
1019	Plasdek Roller 4" / 10 cm	2
1018	Plasdek Roller 6" / 15 cm	2
1181	Paint Tray	6
1219	Paint Tray (for 8" / 20 cm paint roller)	6
1179	Small Paint Tray	12
1483	Premium Small Paint Tray	12
1485	Premium Paint Tray (10" / 25 cm paint roller)	6
1484	Premium Paint Tray (8" / 20 cm paint roller)	6
6467	Premium Oil Paint Robot Brush 3" / 76 mm	6
6468	Premium Oil Paint Robot Brush 4" / 100 mm	6
6477	Premium Water-Based Robot Brush 3" / 76 mm	6
6478	Premium Water-Based Robot Brush 4" / 100 mm	6
	Stand Assembly	

## 9102 127 product Exterior Painting Application

1012	Silteks Roller 10" / 25 cm	4
1010	Silteks Roller 8" / 20 cm	4

Code Product Unit

1003	Superluks Roller 10" / 25 cm	4
1001	Superluks Roller 8" / 20 cm	4
1004	Superluks Roller 6" / 15 cm	4
1005	Superluks Roller 4" / 10 cm	4
1036	Sheepskin Roller 10" / 25 cm	3
1035	Sheepskin Roller 8" / 20 cm	3
1040	Extra Sheepskin Roller 8" / 20 cm	3
1037	Sheepskin Roller 6" / 15 cm	3
1038	Sheepskin Roller 4" / 10 cm	3
1116	Foam Coral Roller 8" / 20 cm	3
1117	Foam Roller With Cavities 8" / 20 cm	3
1118	Foam Roller with Naps 8" / 20 cm	3
1122	Foam Roller with Naps 10" / 25 cm	3
1129	Foam Roller With Cavities 10" / 25 cm	3
1039	Sheepskin Radiator Roller 4" / 10 cm	6
2203	Scraper 8" / 20 cm	3
2202	Scraper 4" / 10 cm	4
2201	Scraper 2" / 5 cm	6
1188	Robot Brush	6
1123	Foam Radiator Roller with Naps 4" / 10 cm	6
1141	Jumbo Paint Tray	1
1487	Premium Jumbo Paint Bucket	1
6470	Premium Water-Based Brush 1" / 25 mm (New)	4
6472	Premium Water-Based Brush 2" / 50 mm (New)	4
6474	Premium Water-Based Brush 3" / 76 mm (New)	4
6475	Premium Oil Paint Robot Brush 4"/100 mm	4
6467	Premium Oil Paint Robot Brush 3" / 76 mm	6
6468	Premium Water-Based Robot Brush 4" / 100 mm	6
6477	Premium Water-Based Robot Brush 3" / 76 mm	6
6478	Premium Water-Based Robot Brush 4" / 100 mm	6
	Stand Assembly	

## 9103 187 product Oil Paint Application

1081	Eksport Roller 10" / 25 cm	16
1080	Eksport Roller 8" / 20 cm	8
1064	Varnish & Oil Paints Roller 10" / 25 cm	4
1065	Varnish & Oil Paints Roller 8" / 20 cm	4
1113	Foam Paint Roller 9"/23 cm	3
1112	Foam Paint Roller 8" / 20 cm	4
3116	Eksport Mid-size Roller 10" / 25 cm	3

Code Product Unit

3115	Eksport Mid-size Roller 8" / 20 cm	3
3113	Eksport Mid-size Roller 6" / 15 cm	3
2086	Eksport Radiator Roller 10" / 25 cm	3
2083	Eksport Radiator Roller 8" / 20 cm	3
1085	Eksport Radiator Roller 6" / 15 cm	3
1082	Eksport Roller 6" / 15 cm	4
1083	Eksport Roller 4" / 10 cm	4
1084	Eksport Radiator Roller 4" / 10 cm	6
6170	Water-Based Paint Brush 1" / 24 mm (New)	6
6172	Water-Based Paint Brush 1,7" / 44 mm (New)	6
6174	Water-Based Paint Brush 2,5" / 64 mm (New)	6
6175	Water-Based Paint Brush 3,3" / 84 mm (New)	6
6176	Water-Based Paint Brush 4" / 100 mm (New)	6
6177	Water-Based Robot Brush 2,5" / 64 mm (New)	4
6178	Water-Based Robot Brush 3,3" / 84 mm (New)	4
1097	Eksport Roller Sleeve 10" / 25 cm	6
1096	Eksport Roller Sleeve 8" / 20 cm	6
1390	Paint Paddle Sticks	6
1391	Paint Paddle Sticks (Perforated)	6
1111	Foam Radiator Roller 2" / 5 cm	6
1180	Large Roller Paint Tray	1
1181	Paint Tray	6
1183	Paint Tray Liner	10
6467	Premium Oil Paint Robot Brush 3" / 76 mm	6
6468	Premium Oil Paint Robot Brush 4" / 100 mm	6
6477	Premium Water-Based Robot Brush 3" / 76 mm	6
6478	Premium Water-Based Robot Brush 4" / 100 mm	6
1486	Premium Large Paint Bucket	1
1490	Premium Hobby Paint Set	3
1482	Premium Hobby Paint Tray	3
	Stand Assembly	

## 9104 289 product Varnish Application

1064	Varnish & Oil Paints Roller 10" / 25 cm	12
1065	Varnish & Oil Paints Roller 8" / 20 cm	8
1067	Varnish & Oil Paints Roller 6" / 15 cm	3
1066	Varnish & Oil Paints Roller 4" / 10 cm	3
2085	Varnish & Oil Paints Rad. Roller 10" / 25 cm	3
2093	Varnish & Oil Paints Radiator Roller 8" / 20 cm	3
1069	Varnish & Oil Paints Radiator Roller 6" / 15 cm	3
1068	Varnish & Oil Paints Radiator Roller 4" / 10 cm	6

Code	Product	Unit
1079	Varnish & Oil Paints Radiator Roller Sleeve 4" / 10 cm	50
3106	Varnish & Oil Paints Mid-size Roller 10" / 25 cm	3
3105	Varnish & Oil Paints Mid-size Roller 8" / 20 cm	3
3103	Varnish & Oil Paints Mid-size Roller 6" / 15 cm	3
3101	Varnish & Oil Paints Mid-size Roller 4" / 10 cm	3
3111	Eksport Mid-size Roller 4" / 10 cm	3
1086	Eksport Corner Roller 1,4" / 3,5 cm	3
1088	Eksport Tube Roller 2,8" / 7 cm	3
2084	Eksport Robot Roller 4" / 10 cm	6
1087	Eksport Radiator Roller 3" / 7,5 cm	6
4100	Eksport Radiator Roller Sleeve Set 4" / 10 cm	6
1114	Foam Paint Roller 4" / 10 cm	4
1115	Foam Radiator Roller 4" / 10 cm	3
6170	Water-Based Paint Brush 1" / 24 mm (New)	6
6172	Water-Based Paint Brush 1,7" / 44 mm (New)	6
6174	Water-Based Paint Brush 2,5" / 64 mm (New)	6
6175	Water-Based Paint Brush 3,3" / 84 mm (New)	6
6176	Water-Based Paint Brush 4" / 100 mm (New)	6
6177	Water-Based Robot Brush 2,5" / 64 mm (New)	4
6178	Water-Based Robot Brush 3,3" / 84 mm (New)	4
1204	Wood Handle Scraper	4
1211	Triangular Scraper	4
1185	Paint Grid	12
1197	Small Paint Grid	20
1485	Premium Paint Tray (for 10" / 25 cm paint roller)	6
1483	Premium Small Paint Tray	12
1480	Premium Paint Grid (for 4" / 10 cm paint roller)	20
6467	Premium Oil Paint Robot Brush 3" / 76 mm	6
6468	Premium Oil Paint Robot Brush 4" / 100 mm	6
6477	Premium Water-Based Robot Brush 3" / 76 mm	6
6478	Premium Water-Based Robot Brush 4" / 100 mm	6
1481	Premium Paint Grid (for 10" / 25 cm paint roller)	12
	Stand Assembly	

## 9114 191 product Paint and Cleaning Brushes

6467	Premium Oil Paint Robot Brush 3" / 76 mm	6
6468	Premium Oil Paint Robot Brush 4" / 100 mm	6
6477	Premium Water-Based Robot Brush 3" / 76 mm	12
6478	Premium Water-Based Robot Brush 4" / 100 mm	12

Code	Product	Unit
6470	Premium Water-Based Brush 1" / 25 mm (New)	12
6472	Premium Water-Based Brush 2" / 50 mm (New)	12
6474	Premium Water-Based Brush 3" / 76 mm (New)	12
6475	Premium Oil Paint Robot Brush 4"/100 mm	12
6177	Water-Based Robot Brush 2,5" / 64 mm (New)	6
6178	Water-Based Robot Brush 3,3" / 84 mm (New)	6
6223	Wash Brush with Pole 1,2 m	3
6170	Water-Based Paint Brush 1" / 24 mm (New)	12
6172	Water-Based Paint Brush 1,7" / 44 mm (New)	12
6174	Water-Based Paint Brush 2,5" / 64 mm (New)	12
6175	Water-Based Paint Brush 3,3" / 84 mm (New)	12
6176	Water-Based Paint Brush 4" / 100 mm (New)	12
6200	Soft Wire Brush	6
6201	Hard Wire Brush	6
6220	Auto Washing Brush	2
6221	Extra Auto Washing Brush	2
6270	Multi-Purpose Scrubbing Brush	3
6271	Scrub Brush	3
6280	Hand Brush	6
6230	Extra Marine Washing Brush	2
6231	Marine Washing Brush	2
	Stand Assembly	

## 9106 78 product Cleaning Tools

6263	Wooden Sweeping Yard Brush 23,6" / 60 cm	1
6264	Wooden Sweeping Yard Brush 31,5" / 80 cm	1
6265	Wooden Sweeping Yard Brush 39,4" / 100 cm	1
6266	Wooden Sweeping Yard Brush 18" / 20 cm	1
6200	Soft Wire Brush	6
6201	Hard Wire Brush	6
6240	Carpet Cleaning Brush	4
6241	Floor Scrub Brush (New)	2
6281	Dustpan and Brush Set (New)	2
2248	Premium Metal Squeegee 11,8" / 30 cm (New)	1
2249	Premium Metal Squeegee 15,7" / 40 cm (New)	1
2250	Premium Metal Squeegee 23,6" / 60 cm (New)	1
1411	Premium Squeegee 15,7" / 40 cm (New)	3
1210	Rubber Wiper 16,7 / 42,5 cm	1
1410	Rubber Wiper 20,7" / 52,5 cm	1

Code	Product	Unit
6260	Wooden Sweeping Yard Brush 11,8" / 30 cm	1
6261	Wooden Sweeping Yard Brush 15,7" / 40 cm	1
6262	Wooden Sweeping Yard Brush 19,7" / 50 cm	1
1392	Paint Cup	3
6223	Wash Brush with Pole	4
6305	Premium Dual Broom 11,8" / 30 cm	3
6306	Premium Dual Broom 15,7" / 40 cm	3
6307	Premium Dual Broom 19,7" / 50 cm	3
6308	Premium Dual Broom 23,6" / 60 cm	3
6255	Pre. Plastic Sweep. Yard Brush 11,8" / 30 cm	3
6256	Pre. Plastic Sweep. Yard Brush 15,7" / 40 cm	3
6257	Pre. Plastic Sweep. Yard Brush 19,7" / 50 cm	3
6258	Pre. Plastic Sweep. Yard Brush 23,6" / 60 cm	3
6295	Premium Plastic Swee. Brush 11,8" / 30 cm	3
6296	Premium Plastic Sweep. Brush 15,7" / 40 cm	3
6297	Premium Plastic Sweep. Brush 9,7"/50 cm	3
6298	Premium Plastic Sweep. Brush 23,6" / 60 cm	3
	Stand Assembly	

## 9107 103 product Decorative Painting Tools

1342	36 Stamp Effect Tool	3
1341	25 Stamp Effect Tool	3
1325	13 Stamp Effect Tool	3
1425	9 Stamp Effect Tool	3
1320	Leather Effect Roller 8" / 20 cm	3
1323	Nylon Effect Roller 8" / 20 cm	3
1321	Leather Rose Effect Roller 8" / 20 cm	3
1346	Thin Effect Roller 8" / 20 cm	3
2090	Varnish & Oil Paints Radiator Roller 2" / 5 cm	12
1111	Foam Radiator Roller 2" / 5 cm	6
1328	Crystal Effect Sponge	4
1326	Leather Rose Effect Tool	4
1327	Deep Relief Sponge	4
1345	Wood Surface Effect Tool 4" / 10 cm	6
1347	Wood Surface Effect Tool 6" / 15 cm	6
1344	Wood Surface Effect Tool 8" / 20 cm	4
1550	Ringed Roller	2
1555	Effect Spatula	6

Code	Product	Unit
1168	Wallpaper Seam Roller 3,5" / 9 cm	3
1184	Mini Paint Tray	3
1482	Premium Hobby Paint Tray	3
1490	Premium Hobby Paint Set	2
1182	Hobby Paint Set	2
1483	Premium Small Paint Tray	6
1491	Premium Paint Set	4
1190	Amateur Painter Set	2
	Stand Assembly	

## 9110 *140 product* Industrial Products

1306	Machine Set (1307 + 1308)	1
2204	Scraper 11,8" / 30 cm	3
2203	Scraper 8" / 20 cm	3
2202	Scraper 4" / 10 cm	5
2201	Scraper 5 cm	5
1211	Triangular Scraper	4
1204	Wood Handle Scraper	4
1529	Aluminium Scraper	4
1532	Aluminium Grip Scraper	3
1301	Scraper with Blast Pipe	1
2223	Scraper Composite Handle 8" / 20 cm	1
1531	Aluminium Scraper	4
2545	Aerated Concrete Shovel 4,3" / 10,5 cm	1
2546	Aerated Concrete Shovel 5,3" / 13,5 cm	1
2547	Aerated Concrete Shovel 6,1" / 15,5 cm	1
2550	Aerated Concrete Trencher 17,7" / 45 cm	1
1212	Stainless Inner Corner Trowel	3
1213	Stainless Outer Corner Trowel	3
1187	Plastic Trowel	2
073	Silk Plastic Trowel	2
1507	Pole Hand Sander	3
1207	Pole Hand Sander	3
1206	Hand Sander	3
1235	Ergonomic Hand Sander	2
1380	Strip Disc Tool 1,8" / 4,5 cm	4
1381	Strip Disc Tool 2" / 5 cm	4
1234	Rubber Hand Sander	2
1530	Mortar Rake 31,5" / 80 cm	1
1215	Mortar Rake 19,7" / 50 cm	1

Code	Product	Unit
1214	Mortar Rake 11,8" / 30 cm	1
1414	Plastic Rake 13,8" / 35 cm	1
1415	Plastic Rake 19,7" / 50 cm	1
1350	Spreader 2,2" / 5,5 cm	6
1351	Spreader 2,8" / 7 cm	6
1353	Spreader 2,2" / 5,5 cm	6
1354	Spreader 2,8" / 7 cm	6
1231	Spreader 4" / 10 cm	12
7200	Broom Holder (New)	6
7002	Mini Scraper (New)	20
	Stand Assembly	

## 9111 *68 product* Industrial Products

1208	Mixer Head Ø 5,5" / 14 cm	2
1209	Mixer Head Ø 3,3" / 8,5 cm	3
1510	Mixer Head Ø 2,6" / 6,5 cm	3
1511	Ager Mixer Head Ø 1,6" / 4 cm	3
1512	Mixer Head Ø 3,1" / 8 cm	3
1513	Butterfly Mixer Head Ø 3,5" / 9 cm	3
1514	Mixer Head Ø 3,5" / 9 cm	3
1515	Mixer Head Ø 2,4" / 6 cm	3
1516	Mixer Head Ø 1,6" / 4 cm	3
1517	Mixer Head Ø 5,5" / 14 cm	2
1518	Mixer Head Ø 5,5" / 14 cm	2
1519	Mixer Head Ø 3,3" / 8,5 cm	3
1520	Mixer Head Ø 2,4" / 6 cm	3
1713	Butterfly Mixer Head - SDS Plus	3
1714	Mixer Head Ø 3,5" / 9 cm	3
1715	Mixer Head Ø 2,4" / 6 cm	3
1226	Ep. Spiked Roller (Small Diameter) 4" / 10 cm	3
1220	Ep. Spiked Roller (Small Diameter) 8" / 20 cm	1
1221	Ep. Spiked Roller (Small Diameter) 10" / 25 cm	1
1222	Ep. Spiked Roller (Small Dia.) 11,8" / 30 cm	1
1223	Ep. Spiked Roller (Large Diameter) 8" / 20 cm	1
1224	Ep. Spiked Roller (Large Diameter) 10" / 25 cm	1
1225	Ep. Spiked Roller (Large Dia.) 11,8" / 30 cm	1
1126	Epoxy Nailed Shoes 12,2" / 31 cm	2
1160	Aluminium Crushing Roller 3,1" / 8 cm	3
1161	Aluminium Crushing Roller 5,1" / 13 cm	3
1089	Eksport Large Roller 11,8" / 30 cm	1
1090	Eksport Large Roller 15,7" / 40 cm	1

Code	Product	Unit
1091	Eksport Large Roller 19,7" / 50 cm	1
1092	Eksport Large Roller 23,6" / 60 cm	1
1140	Adjustable Epoxy Stage Trowel	1
1127	Epoxy Stage Trowel	1
	Stand Assembly	

## 9112 *100 product* Composite Extension Poles

1365	Composite Extension Pole 6,56 ft / 2 m	25
1366	Composite Extension Pole 4,92 ft / 1,5 m	25
1367	Composite Extension Pole 5,90 ft / 1,8 m	25
1368	Composite Extension Pole 6,56 ft / 2 m	25

## 9113 *46 product* Extension Poles

1277	Light Aluminium Pole (Stable) 4,92 ft / 1,5 m	3
1283	2 Stage Light Alu. Slender Extension Pole 9,84 ft / 3 m	3
1293	2 Stage Light Aluminium Extension Pole 8,20 ft / 2,5 m	3
1294	2 Stage Light Aluminium Extension Pole 9,84 ft / 3 m	3
1272	3 Stage Aluminium Thick Extension Pole 9,84 ft / 3 m	3
1296	3 Stage Light Aluminium Extension Pole 13,12 ft / 4 m	3
1173	2 Stage Aluminium Thick Extension Pole 9,84 ft / 3 m	3
1370	Wood Tipped Composite Pole (Stable) 4,92 ft / 1,5 m	3
1372	Extreme Composite Pole (New) 4,92 ft / 1,5 m	3
1286	Adjustable Boat Hook 6,56 ft / 2 m (2 Stage)	2
1284	Boat Hook (Stable) 4,92 ft / 1,5 m	2
1289	Flow-Thru Water Pole 3,28 ft / 1 m	3
1178	Travel Extension Pole (3 Stage) 4,59 ft / 1,4 m	3
1297	3 Stage Light Aluminium Extension Pole 19,68 ft / 6 m	3
1274	3 Stage Aluminium Thick Extension Pole 16,40 ft / 5 m	3
1363	2 Stage Composite Extension Pole 8,20 ft / 2,5 m	3
	Stand Assembly	

## 1300\* *1 product* Machine

1300	Whitewash Tank	1
------	----------------	---

## 1302\* *1 product* Machine

1302	Interior Decorate Spraying Machine	1
------	------------------------------------	---

For products 1302 and 1300 please call for more information

# NOTES

A series of 20 horizontal gray bars, stacked vertically, intended for writing notes. Each bar is a solid light gray rectangle spanning most of the page width.



Dekor Roller Firça Sanayi ve Limited Şirketi reserves the rights to modify or upgrade the products, codes and product specifications without notice.

Products are manufactured in Dekor facilities.

[dekor.com](http://dekor.com) [info@dekor.com](mailto:info@dekor.com)

 /dekorrulo

 /dekorrulofirca

