

L200



PODER

PARA LA AVENTURA

Experimenta un nivel superior de resistencia con la nueva L200. Su ingeniería avanzada y sus características ultrarresistentes redefinen la fiabilidad y la robustez de las camionetas pickup. Prepárate para una nueva aventura y un nuevo estilo de vida con la L200.



POTENTE, CONFIABLE Y LISTA PARA LA ACCION



2.4L
TURBO DIESEL ENGINE

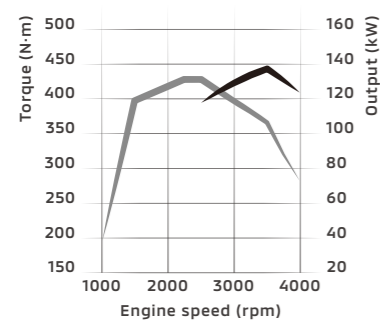

**New 2.4L
Turbo Diesel Engine**
Experimente potente aceleración y
respuesta con hasta 200hp de
potencia y 430 Nm de torque





DESCUBRE LA AVENTURA EN CUALQUIER CAMINO

Llega a cualquier lugar con el mayor rendimiento todoterreno de su clase, perfeccionado a través de rigurosas pruebas y rallies en condiciones extremas en todo el mundo.



Super Select 4WD-II

El exclusivo sistema Super Select 4WD-II de MITSUBISHI MOTORS proporciona un rendimiento excepcional en todo tipo de terrenos gracias a sus cuatro modos seleccionables, incluido el 4H (tracción integral permanente) que ofrece una gran estabilidad incluso en superficies mojadas y un excelente rendimiento en curvas incluso en pavimento seco.

	2H 2WD		4H Full-time 4WD
	4HLc Centre Diff Locked 4WD		4LLc Bloqueo diferencial central bloqueado y marcha baja

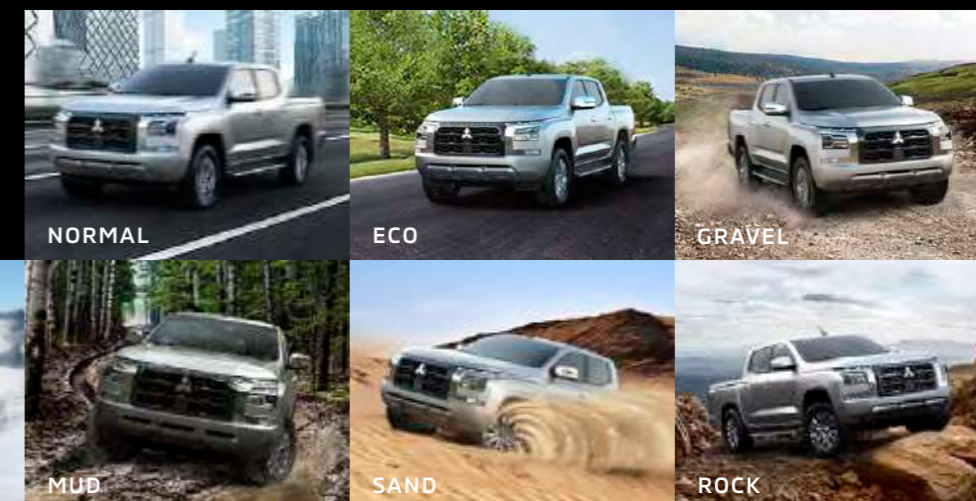

TOTAL CONFIANZA

PARA CONTROL TOTAL



Active Yaw Control [AYC]

The AYC system helps you precisely handle slippery roads with gravel and snow, turning the car just as you want – an exciting driving experience for those who enjoy sporty or off-road driving.

Active Stability and Traction Control [ASTC]

ASTC applies brake force whilst cornering to maintain vehicle stability and optimise traction to prevent torque loss. The system adjusts engine output and applies brake force to spinning wheels as needed.

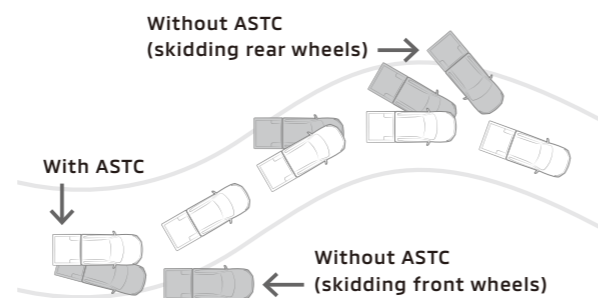

Active Limited Slip Differential (Brake Control Type)

Helps prevent wheel spin on slippery roads by applying brake force to spinning wheels, ensuring better control and road grip.

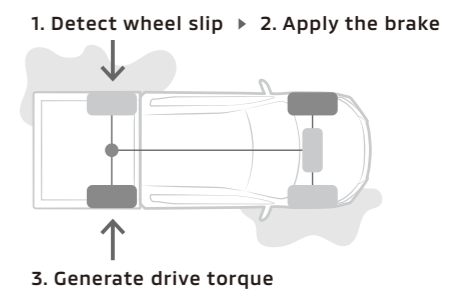

FREEDOM TO EXPLORE THE NEXT FRONTIER



Hill Start Assist [HSA]

HSA helps prevent rolling backward on steep slopes by maintaining braking force for up to two seconds after the brake is released. This helps ensure a safe start until the accelerator is applied.

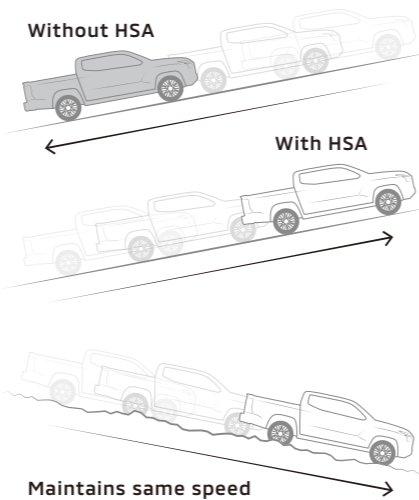

Hill Descent Control [HDC]

HDC applies brakes and maintains speed when travelling downhill, for safer steering without manual brake application. Activates at 2-20 km/h in automatic, and in 1st gear at 3-20 km/h in manual vehicles.



BUILT TO GO ANYWHERE



New Chassis Frame

The chassis frame is built with high-tensile materials to withstand tough terrain and ensure reliable performance in any condition. It's the foundation of outstanding driving performance and ride comfort on any terrain.



Completely Redesigned Suspension System

The completely redesigned front and rear suspension systems enhance driving performance and comfort by providing superior handling on various road types.



Front suspension



EMPOWERS ANY JOURNEY

The interior is designed for comfort during long trips, with advanced technology and a thoughtfully crafted living space that empowers you to enjoy your ride, no matter where your journey takes you.



9-inch Infotainment System

Enjoy a stress-free and enjoyable time in the vehicle with the intuitive and convenient 9-inch infotainment system that comes with smartphone connectivity and an easy-to-see display.

Combination Meter

The new 7-inch multi-information display puts all the necessary information in front of you, allowing you to easily understand the vehicle's status at a glance. The new meter display also makes recognition effortless.



•MAPS •MUSIC •PHONE •SIRI •MESSAGES •APPS
 Note: Apple CarPlay is a trademark of Apple Inc., registered in the U.S. and other countries.
 For more information: www.apple.com/ios/carplay/



•MAPS •MUSIC •PHONE
 •GOOGLE ASSISTANT •MESSAGES •APPS
 Note: Google, Google Assistant, Android, Android Auto and other related marks are trademarks of Google LLC.
 For more information: www.android.com/auto/



SPACE TO SHARE AND ENJOY



Seat Comfort

Enjoy enhanced comfort during long rides with the newly designed seats inspired by our rally heritage. The seats provide excellent body support, allowing you to focus on driving and enjoy the journey.

Upgraded Air Conditioning

Stay cool and comfortable even on hot days with the improved A/C system. The front A/C unit provides exceptional cooling performance to keep you refreshed during your drive. Plus, the rear air circulator keeps passengers comfortable with airflow adjustable to their personal preferences.



Note: Some equipment may vary by market. Please consult your local MITSUBISHI MOTORS dealer/distributor for details.



MODERN INTERIOR FOR PROFESSIONALS

User-Friendly Components

The interior is designed to enhance your driving experience with user-friendly components that are intuitive to use, with every detail crafted with your comfort and convenience in mind.



Easy-to-Grip and Comfortable Steering Wheel



Glove-Friendly and Intuitive Air Conditioning Switches

Soft-to-Touch and 3D-Shaped Intuitive Door Handles

Convenient Tech and Storage Solutions

Make your drive convenient and enjoyable with an interior equipped with tech and storage solutions. Stay organised with ample storage space for all your items.



Smartphone Wireless Charger

Rear USB Ports (A&C Type)

Upper Glove Box

THE ULTIMATE WORKHORSE

THAT GETS THE JOB DONE



Single CAB



Double CAB

Big and Practical Cargo Space

Easily carry all your essentials, including a Euro pallet, with the versatile cargo bed. It's designed to handle everything you need, and more.

Practical Features



Wide Side Step

Designed to provide slip-resistant footing for safe and easy entry and exit from the vehicle, even in wet or slippery conditions.

Rear Bumper Corner Shape

The rear bumper corner allows for more foot space when the tailgate is open, and it has the largest step area in its segment.



2x4 Lumber Attachment

Easily divide your cargo space with the 2x4 lumber attachment.

Rear Inner Hook Placed Low

Low-placed rear inner hook allows for easy and secure tie-down of loads.

PEACE OF MIND WITH ADVANCED SAFETY FEATURES



Mitsubishi Motors Safety Sensing [MMSS]

MITSUBISHI MOTORS offers advanced safety features through MMSS, giving our customers peace of mind during every adventure and ensuring a safe return home.

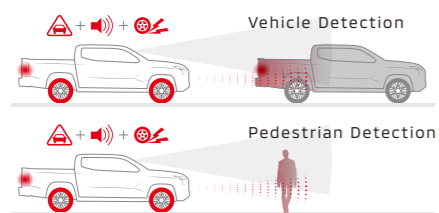

Forward Collision Mitigation system [FCM]

FCM can help detect vehicles and pedestrians and alert the driver with audio and visual warnings, as well as apply the brakes to avoid or reduce potential collisions.

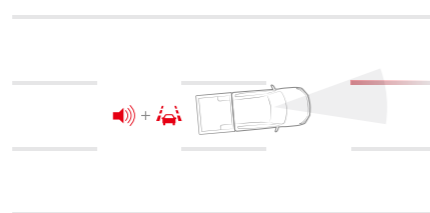

Lane Departure Warning [LDW]

LDW warns the driver with visual and audible alerts when the vehicle unintentionally crosses lane markings at speeds over 65km/h, using a windshield-mounted camera.

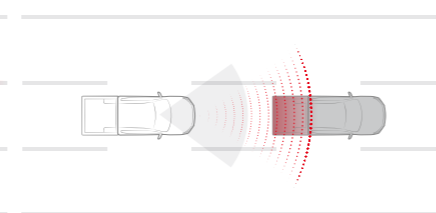

Adaptive Cruise Control [ACC]

ACC uses advanced radar and camera technology to judge the distance to the vehicle ahead and automatically adjusts the car's speed to maintain the set driving distance.

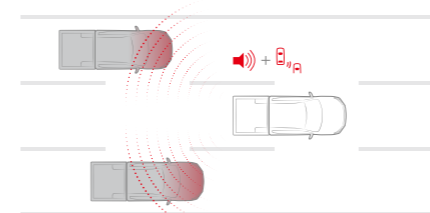

Blind Spot Warning [BSW] with Lane Change Assist [LCA]

Rear bumper radar sensors detect vehicles in blind spots on both sides. If a vehicle is detected whilst the turn signal is on, an indicator blinks in the corresponding side mirror and a buzzer sounds.

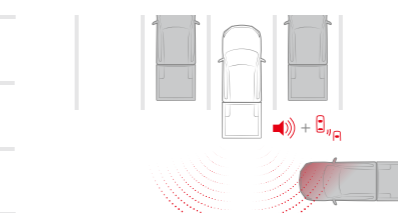

Rear Cross Traffic Alert [RCTA]

When reversing, if radar sensors detect a moving vehicle, the system warns through visual, audible, and side mirror alerts, helping to enhance safety and prevent potential collisions.

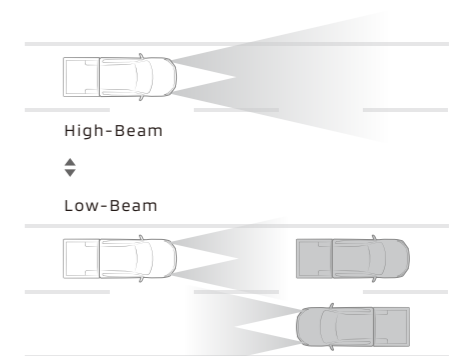

Automatic High-Beam [AHB]

Automatically switches headlights between low and high beam based on the presence of a vehicle ahead for safer and more comfortable night-time driving.

Note: The radar wave graphics are for illustrative purposes only and do not represent the actual sensor application. Drivers are fully responsible for their own safe driving. Please drive safely and do not rely solely on these systems whilst driving. Some equipment may vary by market. Please consult your local MITSUBISHI MOTORS dealer/distributor for details.



Connected Services

MITSUBISHI CONNECT offers connected services for safe and convenient driving, accessible through a smartphone app.

Safety

- Automatic Collision Notification
- SOS Emergency Assistance (eCall)
- Roadside Assistance

Security

- Stolen Vehicle Assistance
- Remote Door Lock/Unlock
- Parental Control
- Over-the-Air Update (Firmware Update)

Comfort & Convenience

- Remote Climate Control
- Vehicle Status Report
- Information Assistance
- Car Finder (GPS)
- Mileage Tracker
- Remote Horn, Lights

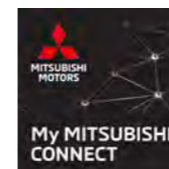

My MITSUBISHI CONNECT App

MITSUBISHI CONNECT services can be accessed through a smartphone app available on both Apple App Store and Google Play, providing easy access to all available services.

Note: Apple is a trademark of Apple Inc., registered in the U.S. and other countries and regions. App Store are a service mark of Apple Inc., registered in the U.S. and other countries and regions. Google Play is a trademark of Google LLC.



CONNECTIVITY IN THE PALM OF YOUR HAND



STRONGER. STURDIER. TOUGHER.

There's no limit to how tough you can be. Reach new levels of toughness and make your TRITON even more capable – and truly your own.

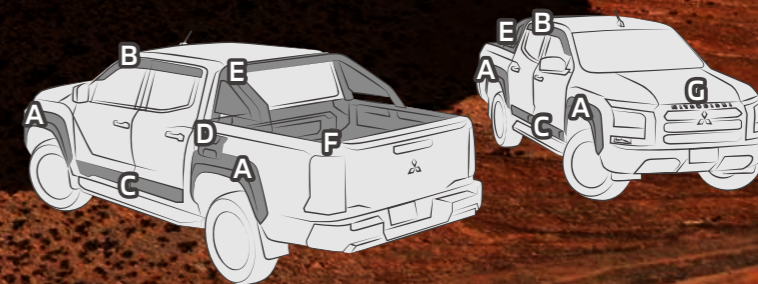

- A. Fender Arch Moulding
- B. Side Window Deflector
- C. Side Door Garnish

- D. Fuel Lid Garnish
- E. Sport Bar
- F. Bed Liner
- G. Grille Emblem



Scan to learn more.

Why Genuine Accessories?

We design and test our genuine accessories to seamlessly integrate with our vehicles for safety, functionality, and durability. Our accessories comply with regional regulations and are available globally thanks to our strong development, procurement, and Japanese manufacturing tradition.



DESIGN

We design and develop our genuine accessories alongside our vehicles to ensure they harmoniously and seamlessly integrate with the vehicle's original design.



SAFETY

We rigorously test all our genuine accessories to meet safety standards and ensure they work seamlessly with the vehicle's advanced safety equipment.



DURABILITY

We test our genuine accessories under various conditions for durability, which is essential for safety. If any issues arise, we analyse them to improve both the accessories and the vehicle itself.



FUNCTIONALITY

We design our accessories to improve vehicle functionality and meet regional requirements, whilst also considering how they work with advanced safety features.

Note: These accessories are not covered by the vehicle warranty and are subject to the conditions of the accessory warranty. For warranty conditions regarding these accessories, please contact an authorised MITSUBISHI MOTORS dealer. Some equipment may vary by market. Please consult your local MITSUBISHI MOTORS dealer/distributor for details.

VARIATIONS

DOUBLE CAB

GT

[2WD] 6MT / 6AT



Leather



Image shows MT model

DOUBLE CAB

GLS

[2WD] 6MT / 6AT
[4WD] 6MT



Leather



Image shows AT model (2WD)

DOUBLE CAB

GLX

[2WD] 6MT



Fabric (with Stitch)



SINGLE CAB

GL

[4WD] 6MT / 6AT



Vinyl



Image shows MT model (4WD)

Note: Vehicles with genuine leather seats use synthetic leather for parts of the seat surface, sides, backside, headrest, rear centre armrest, and door trim fabric. Some equipment may vary by market. Please consult your local MITSUBISHI MOTORS dealer/distributor for details.

BODY COLOURS



Yamabuki Orange Metallic [M14]



Graphite Gray Metallic [U28]



Blade Silver Metallic [U33]



Red Solid [P63]



Deep Bronze Metallic [C17]



White Diamond [W85]



Impulse Blue Metallic [D23]



Jet Black Mica [X37]



White Solid [W19]

	Single cab	Double cab
Yamabuki Orange Metallic [M14]		
Graphite Gray Metallic [U28]		
Blade Silver Metallic [U33]		
Red Solid [P63]		
Deep Bronze Metallic [C17]		
White Diamond [W85]		
Impulse Blue Metallic [D23]		
Jet Black Mica [X37]		
White Solid [W19]		

SEAT MATERIALS



Vinyl



Fabric (with Stitch)



Leather

	Single cab	Double cab
Vinyl		
Fabric (with Stitch)		
Leather		

Note: Colours shown may differ slightly from actual colours due to printing process. Please consult your local MITSUBISHI MOTORS dealer/distributor for actual colours. Leather seats include synthetic leather on the sides, rear, partial seating surfaces and head restraint (also on rear centre armrest sides, door armrests and door trim, etc.). Some equipment may vary by market. Please consult your local MITSUBISHI MOTORS dealer/distributor for details.

STANDARD and OPTIONAL EQUIPMENT

(Fill in according to your region's specifications. Do not print this version.)

■ Standard □ Optional — Not available

Models	GL	GLX	GLS	GT
Drivetrain and Chassis				
2WD				
Easy Select 4WD				
Super Select 4WD-II				
Rear differential lock (without limited slip differential)				
Front suspension (Double wishbone with coil spring)				
Rear suspension Normal type				
Elliptic leaf spring Heavy duty type				
Front ventilated disc brake, 2-pot (Diameter: 290mm)				
Front ventilated disc brake, 2-pot (Diameter: 320mm)				
Rear drum brake (11.6-inch)				
Tyre and Wheel				
205R16C 8PR 110/108R with 16-inch steel wheels (Silver)				
Spare: 205R16C 8PR 110/108R + 16-inch steel wheel (Silver)				
265/70R16 (All-season tyre) with 16-inch alloy wheels (Silver)				
Spare: 265/70R16 (All-season tyre) + 16-inch alloy wheel (Silver)				
265/65R17 (All-season tyre) with 17-inch alloy wheels (Silver)				
Spare: 265/65R17 (All-season tyre) + 17-inch alloy wheel (Silver)				
265/60R18 (All-season tyre) with 18-inch alloy wheels (Silver)				
Spare: 265/60R18 (All-season tyre) + 18-inch alloy wheel (Silver)				
Driving Performance				
Drive Mode				
Active Yaw Control [AYC]				
Hill Start Assist [HSA]				
Exterior				
Windscreen glass (Laminated glass with UV ray reduction)				
Front bumper Material black				
Colour-keyed				
Front bumper garnish Chrome				
Front fog light bezel Chrome				
Front grille Material black				
Colour-keyed				
Wiper Front windscreen variable intermittent wiper (2-speed)				
Rain-sensing windscreen wiper				
Windscreen washer (Nozzle type)				
Rear window defogger with timer				
Side step Material black				
Silver painted				
Side door garnish (Material black)				
Outer door handle Material black				
Chrome				
Door mirror Electrically adjustable				
Power folding				
Material black				
Chrome				
Rear body guard frame				
Rear bumper				
Rear spoiler				
"CLEAN DIESEL" badge				
Rear gate handle Bar type				
Pull-up type				
Colour-keyed				
Chrome				
Rear gate lock				
Cargo bed Outer hook x 12				
Inner hook x 4				
Towing hook (Front)				
Cockpit				
Multi-information display 3.5-inch display				
7-inch colour LCD				
Urethane steering wheel (3-spoke type)				
Leather-wrapped steering wheel (3-spoke type)				

Models	GL	GLX	GLS	GT
Cockpit				
Tilt and telescopic steering wheel				
Gearshift knob Leather-wrapped				
Gearshift lever boot Synthetic leather with stitch				
Parking brake lever				
Release switch Material black				
Chrome				
Seat				
Seat material Vinyl				
Fabric with stitch				
Leather				
Driver seat Manual adjustable seat (Sliding, reclining)				
Manual adjustable seat (Sliding, reclining, single-height)				
Power seat (Sliding, reclining, double-height, lumbar support)				
Passenger seat Manual adjustable seat (Sliding, reclining)				
Seatback pocket with multiple pockets				
Front seat height adjustable headrest				
Rear centre armrest (with cup holder)				
Interior				
Instrument panel accent Material black				
Synthetic leather wrapped with stitch				
Upper glove box without lid				
with lid				
Lower glove box				
Floor console Material black				
Colour-keyed				
Floor console box with lid				
with lid (Synthetic leather)				
Cup holder for floor console x 2				
Central door locking system				
Speed sensing automatic central door lock				
Child safety lock				
Remote keyless entry				
Keyless Operation System [KOS]				
Inner door handle Material black				
Satin chrome				
Front door trim Synthetic leather insert without stitch				
Synthetic leather insert with stitch				
Front door armrest Material black				
Synthetic leather without stitch				
Synthetic leather with stitch				
Power window switch panel (Material black)				
Driver side door power window switch (Auto up/down and anti-trap function)				
Passenger side and rear door power window switch (Up and down)				
Key-off timer function				
Room light Front (Bulb)				
Rear (Bulb)				
Front map light (Bulb)				
Sunglass pocket				
Floor carpets Vinyl				
Needle punch				
Sunvisor x 2 Vanity mirror with lid and ticket holder (Driver's side)				
Vanity mirror with lid (Passenger's side)				
Dimming rearview mirror				
Switch with illumination				
Air Conditioner				
Manual air conditioning				
Automatic air conditioning				
Dual-zone automatic air conditioning				
Rear air circulator				

■ Standard □ Optional — Not available

Models	GL	GLX	GLS	GT
Safety and Security				
Mitsubishi Motors Safety Sensing [MMSS]				
Forward Collision Mitigation system [FCM] with pedestrian detection				
Blind Spot Warning [BSW] with Lane Change Assist [LCA]				
Rear Cross Traffic Alert [RCTA]				
Automatic High Beam [AHB]				
Active Stability and Traction Control [ASTC]				
Emergency Stop Signal system [ESS]				
Brake override system				
Anti-lock Braking System [ABS]				
Electronic Brake force Distribution [EBD]				
Brake assist system				
Parking sensor (Front and rear)				
Immobiliser				
Passive safety				
SRS airbag (Driver, Passenger, Knee (Driver))				
SRS airbag (Driver, Passenger, Side (Front), Curtain (Front and rear), Knee (Driver))				
Passenger SRS airbag cut-off switch (Manual)				
Front 3-point seatbelt with Emergency Locking Retractor [ELR]				
Double pretensioner (Driver) and pretensioner (Passenger)				
Height-adjustable front seatbelt anchor				
Rear seat 3-point seatbelt with ELR				
ISO-FIX child restraint seat anchor and tether anchor				
Front x 1				
Rear x 2				
Navigation and Audio				
Smartphone-link Display Audio [SDA] navigation system (9-inch WVGA display)				
Speaker				
2-speaker				
4-speaker				
6-speaker				
Hands-free phone and voice recognition				
Steering wheel audio control				
Lighting and Visibility				
Halogen headlight				
LED headlight (High/low beam)				
Auto light system with off switch				
LED Daytime Running lamps [DRL]				
Front turn signal (Bulb)				
Side turn signal Bulb type on fender				
LED on door mirror				
Position (Clearance) light Bulb				
LED				
Front fog light (LED)				

Models	GL	GLX	GLS	GT
Lighting and Visibility				
Stop light Bulb				
LED				
Tail light Bulb				
LED				
Rear turn signal (Bulb)				
Rear combination light Bulb				
LED				
Back-up light (Bulb)				
License plate light (Bulb)				
LED high-mount stop light				
Welcome light				
Coming home light				
Convenience				
12V power outlet Floor console				
Instrument panel				
USB port for charging x 2 (Rear console)				
Rearview camera				
Multi Around Monitor with Moving Object Detection [MOD]				
Hands-free phone				
Microphone				
Wireless charger				
USB charging outlet x 2				
Tool set (Simple set, wheel nut wrench) and Jack				
Accessory				
Multifunction global display audio with 10-inch display				
Floor mat Rubber type				
Needle punch				

WARNING

•Individuals who use implantable pacemakers or implantable cardioverter-defibrillators should keep away from the Keyless Operation System.
The electromagnetic waves used in the Keyless Operation System may affect the operation of implantable pacemakers or implantable cardioverter-defibrillators.
•Individuals using other electro-medical apparatuses should check with the manufacturer of the apparatus to confirm the effect of the electromagnetic waves used by the Keyless Operation System, as the electromagnetic waves may affect their operations.

•The items in the "Accessory" category are MITSUBISHI MOTORS Genuine Accessories fitted at factory.

•These accessories are not covered by the vehicle warranty and are subject to the conditions of the accessory warranty.

•For warranty conditions regarding these accessories, please contact an authorised MITSUBISHI MOTORS dealer.

NOTES ON SMARTPHONE-LINK DISPLAY AUDIO

- Google, Google Assistant, Android, Android Auto and other related marks are trademarks of Google LLC.
- iPhone, Siri and Apple CarPlay are trademarks of Apple Inc., registered in the U.S. and other countries.
- Android Auto requires the Android Auto app on Google Play and an Android compatible smartphone running Android™ 5.0 Lollipop or higher.
- Apple CarPlay requires an iPhone with iOS 8 or higher.
- Despite the expansion of supporting countries, Android Auto and Apple CarPlay are NOT available in some markets. Please check the website for the latest information on availability.
– Android Auto: <https://www.android.com/auto/#country-list>
– Apple CarPlay: <http://www.apple.com/ios/feature-availability/#applecarplay-applecarplay>

- Android Auto and Apple CarPlay may not work under weak or no network condition even in supported areas.
- Customer is responsible for all communication fees. Also customer may be charged extra fees based on their contracted price plan by the telecom carriers.
- Customer may be requested to subscribe for roaming services by the telecom carriers when using in other countries.
- Not all smartphone Apps are compatible with Android Auto or Apple CarPlay. For safety reasons, only compatible apps are available in this Smartphone-link Display Audio.
- Some features or apps may not be available for all countries or all areas.
- The images used may not reflect the latest updates.
- Please check this website to confirm smartphones compatibility with Smartphone-link Display Audio.
<https://www.mitsubishi-motors.com/en/products/SDA/>

TECHNICAL SPECIFICATIONS

	Double Cab					Single Cab			
	2WD					4WD			
	GLX	GLS	GT	GLS	GT	GLS	GL	GL	
	LB2TJJDJCRU	LB2TJJHJCRU	LB2TJJGJCRU	LB2TJLHJCRU	LB2TJLGJCRU	LC2TJJHJCRU	LC2TEJUJCRU	LC2TELUJCRU	
Dimension and Weight									
Overall length	mm	5,320					5,265		
Overall width	mm	1,865							
Overall height	mm	1,795					1,765		
Wheelbase	mm	3,130							
Min. ground clearance	mm	222					203		
Cargo floor height	mm	820					800		
Minimum turning radius	m	6.2							
Kerb weight	kg	1,865	1,895	1,910	1,890	1,900	2,000	1,880	
Gross vehicle weight	kg	3,000							
Seating capacity		5					2		
Fuel System									
Injection system		Electrical Fuel Injection (Common rail)							
Fuel tank capacity	litres	75							
Engine									
Type		2.4-litre inline-4 intercooled turbocharged DOHC diesel with Auto Stop and Go (4N16)							
Displacement	cc	2,442							
Bore x stroke	mm	86.0 x 105.1							
Compression ratio		15.2							
Max. output (DIN NET)	kW/rpm	135 / 3,500							
Max. torque (DIN NET)	N·m/rpm	430 / 2,250-2,500							
Transmission									
Type		6MT		6AT		6MT		6AT	
Gear ratio		4.692	3.600	2.090	1.474	4.692	2.090	3.600	
		2.482	1.488	1.000	0.778	2.482	1.488	1.000	
		1.474	1.000	0.687	0.580	1.474	0.687	0.580	
		1.000	0.661	0.666	3.732	1.000	0.661	0.580	
		0.778	0.661	4.666	3.732	0.778	4.666	3.732	
		0.661	-	-	-	0.661	1.000	1.000	
		4.666	-	-	-	4.666	2.566	2.566	
		3.692	4.090	3.692	4.090	3.692	4.090	4.090	
Performance									
Max. speed*	km/h	180					170		
Steering									
Type		Rack and pinion							
Suspension									
Front		Independent-wishbone, coil springs							
Rear		Rigid leaf springs							
Brake									
Front		Ventilated disc (Diameter 290mm)	Ventilated disc (Diameter 320mm)				Ventilated disc (Diameter 290mm)		
Rear		11.6-inch LT drum							
Tyre									
Tyres (Front and rear)		265/70R16 112S	265/65R17 112H	265/60R18 110H	265/65R17 112H	265/60R18 110H	265/65R17 112H	205R16C 8PR 110/108R	

* Measured by MITSUBISHI MOTORS CORPORATION. Your actual mileage will vary depending on how you drive and maintain your vehicle.
Note: These specifications are subject to change without notice. Please consult your local MITSUBISHI MOTORS dealer/distributor for detailed specifications.

DIMENSIONAL VIEWS

(Fill in according to your region's specifications. Do not print this version.)

DOUBLE CAB (GT)

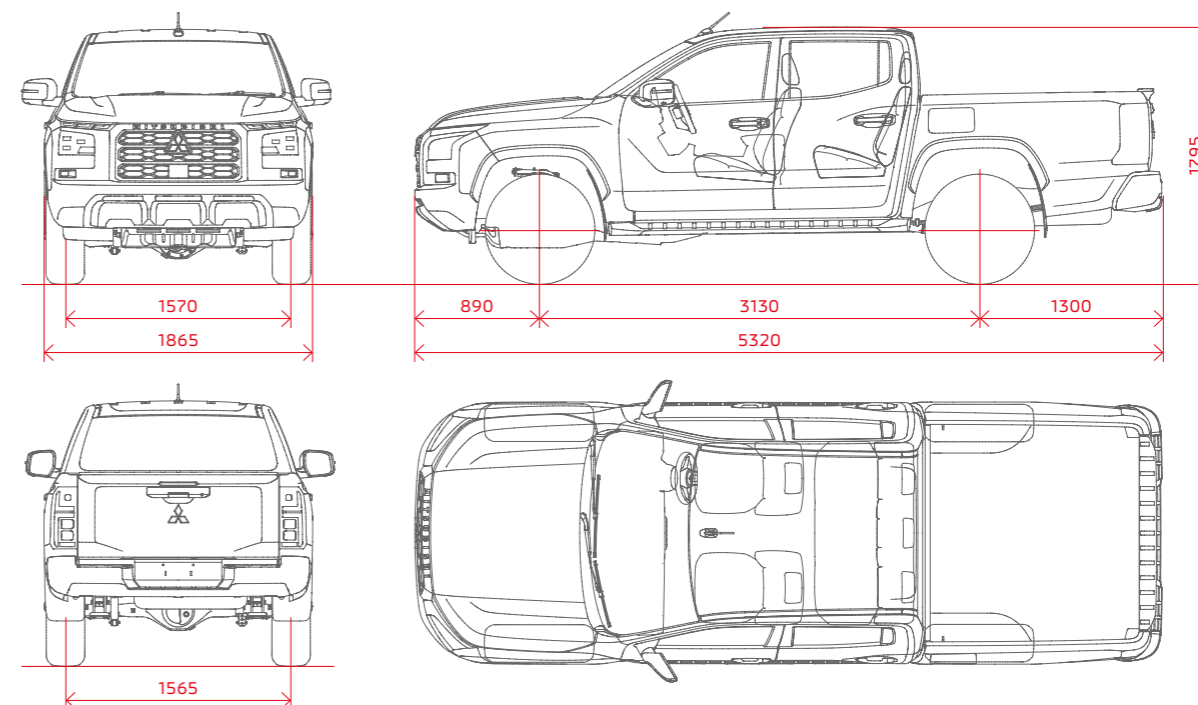

SINGLE CAB (GL)

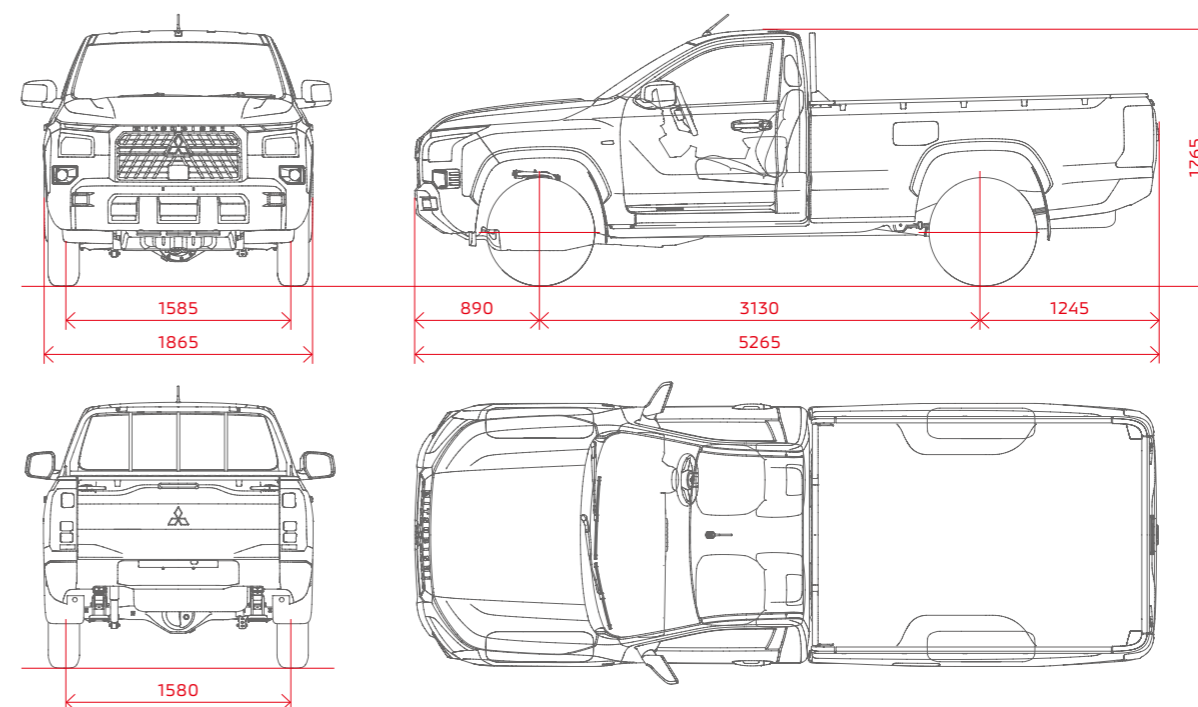

All measurements in millimetres

Note: **-ASTC:** The control capabilities of Active Stability and Traction Control [ASTC] are supplemental only. Please drive safely and never rely solely on these functions whilst driving. Be sure to use the same specified type and size of tyres on all 4 wheels. Do not install any aftermarket limited slip differential on your vehicle. **-HSA:** Hill Start Assist [HSA] is not a substitute for safe driving. Never rely solely on this function whilst driving on steep roads. Your vehicle may move backwards if the brake pedal is heavily loaded, or if the road is very steep or slippery. This function is not designed to keep the vehicle stopped in place on uphill slopes for more than 2 seconds. Do not rely on this function to maintain a stopped position as an alternative to depressing the brake pedal. **-HDC:** Hill Descent Control [HDC] is not a substitute for safe driving. Never rely solely on this function whilst driving on steep roads. When driving on slippery roads such as muddy, icy, or unpaved roads, your vehicle will not allow you to stay at a certain low speed, which may lead to a serious accident. **-FCM:** The detection and control capabilities of Forward Collision Mitigation system [FCM] are supplemental only and do not prevent collisions in every situation. FCM may not detect vehicles and pedestrians in some situations. Auto braking is activated for a car ahead when your vehicle is travelling at a speed of above approx. 10 km/h and for a pedestrian ahead at approx. 10 km/h to 80 km/h. Since FCM has no function to maintain braking, the brake is released approximately 2 seconds after stopping. To prevent the vehicle from rolling thereafter, the driver may have to hold the brake pedal down. In some cases, FCM may not function if the driver takes actions for accident avoidance through steering or acceleration operation. **-LDW:** Lane Departure Warning [LDW] is not designed to lessen risks associated with not looking ahead carefully (attention drawn to something on the side, absentmindedness, etc.) or poor visibility caused by bad weather etc. Keep steering your vehicle correctly and drive safely. The system may not be able to detect the lane correctly in some conditions.

-ACC: The detection and control capabilities of Adaptive Cruise Control [ACC] are supplemental only. ACC may not be activated in some situations. This system may not correctly detect the actual situation depending on the type of vehicle in front and its conditions, the weather conditions, and the road conditions. Additionally, the system may be unable to decelerate sufficiently if the vehicle in front applies the brakes suddenly or another vehicle cuts into your path, so your vehicle approaches the front vehicle. The operating speed range is approx. 25 km/h to 144 km/h. **-BSW/LCA:** The detection and control capabilities of the Blind Spot Warning system [BSW] / Lane Change Assist [LCA] are supplemental only and do not warn you of vehicles in blind spots in every situation. Please do not rely solely on this system whilst driving. BSW/LCA may not operate normally in some cases, depending on traffic, weather, road surface conditions and the presence of obstructions. **-RCTA:** Do not rely solely on Rear Cross Traffic Alert [RCTA], which may not detect all moving vehicles in certain conditions. **-AHB:** This system activates at a speed of approx. 40 km/h or more and deactivates at lower speeds.

Drivers are fully responsible for their own safe driving. Please drive safely and do not rely solely on these systems whilst driving. Please see the owner's manual for additional information. If you have any questions, please consult your local MITSUBISHI MOTORS dealer/distributor for details.