

Novatik
NATURE | CLASSIC

Novatik
NATURE | SLATE

Novatik
NATURE | WOOD

Novatik
NATURE | ROMAN

Novatik
NATURE | STONE

INSTALLATION GUIDE

OVER THE BATTENS

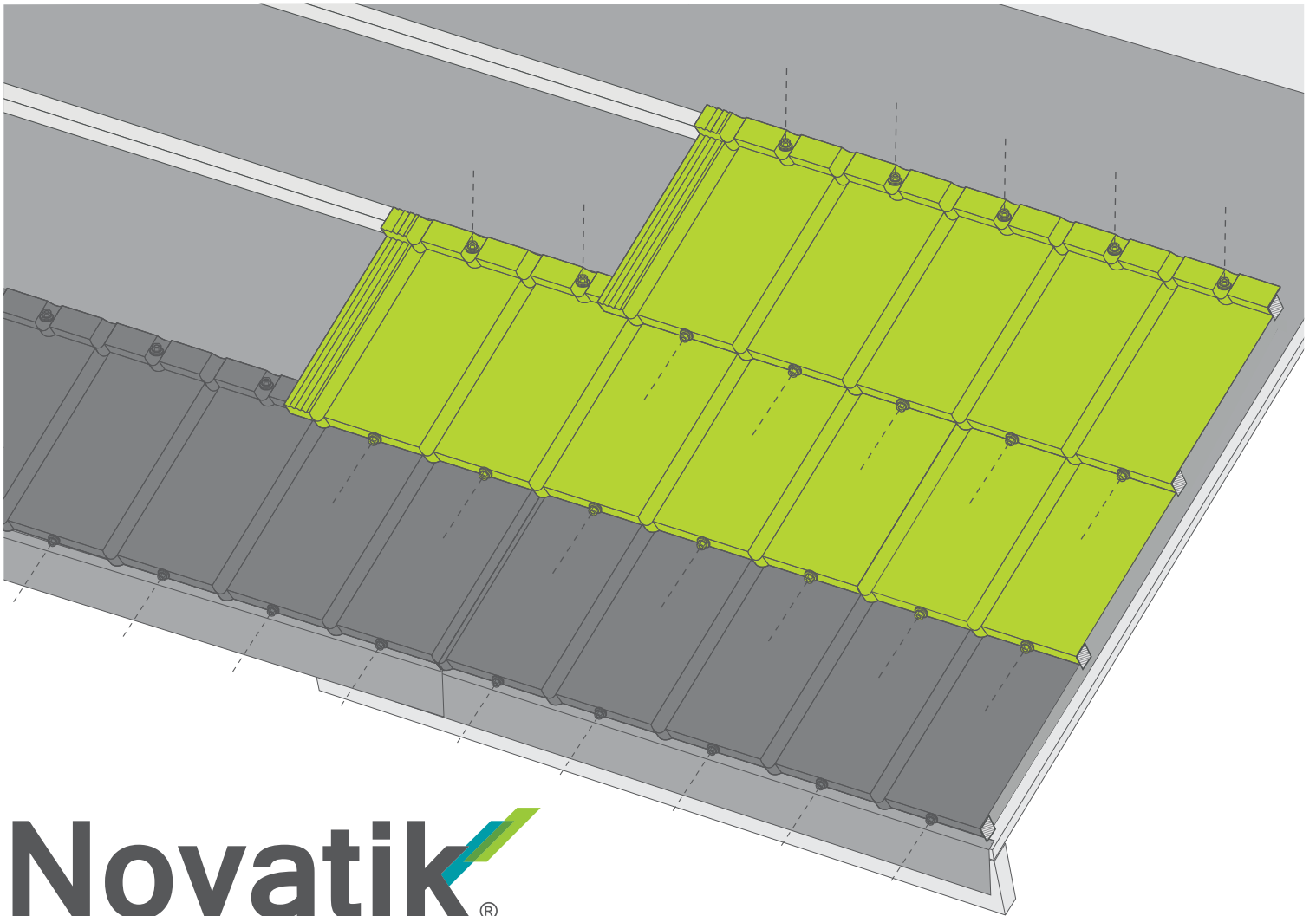

Novatik®

“A ROOF FOR NINE LIVES,
GUARANTEED BY THE EXPERTS!”

NOVATIK.US

TABLE OF CONTENTS

1	List of Accessories _____	3
2	List of Required Tools for Installation _____	4
3	Safety and other Statement _____	5
4	Eave flashing installation _____	6
5	Valleys installation _____	7
6	Panels installation _____	8
7	Hips + ridges installation _____	9
8	Box barges installation _____	10
9	Side wall falshing installation _____	11
10	Wall flashing scribed installation _____	12
11	Notes _____	13

List of Accessories

Novatik® NATURE

STONE COATED METAL ROOF ACCESSORIES

Novatik offers a complete range of roofing accessories. Installing accessories correctly ensures that the roof is weatherproof and properly ventilated, as well as more visually appealing.



LIST OF REQUIRED TOOLS FOR INSTALLATION



Soft-soled shoes
(without metal inserts)

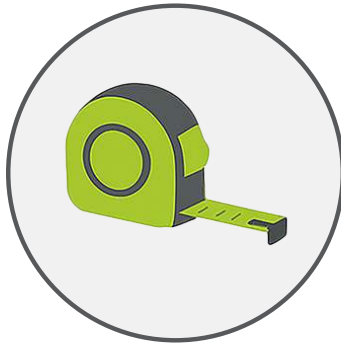

Measuring tape



Metal snips



Bender

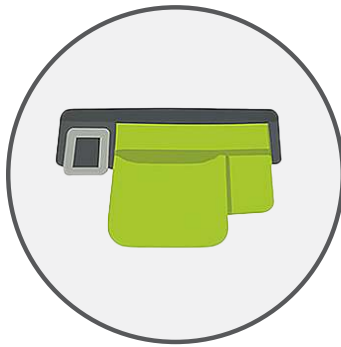

Tool belt



Screw gun /
cordless drill



Marker or pencil



Caulking gun



Silicone

SAFETY AND OTHER STATEMENTS

SAFETY STATEMENT

Safety must always come first. All installers should carefully review and follow applicable OSHA, state, and local safety requirements before and during any roofing installation.

MATERIAL ESTIMATION

Estimation sheets are available for all Novatik product lines. Please contact your local Novatik representative for assistance in preparing takeoffs and calculations.

ROOF SLOPE REQUIREMENTS

Novatik CF roofing systems are designed for roof slopes of **2:12 (9.5°) or greater**. Roofs with slopes less than 2:12 (9.5°) are considered decorative only and must be installed over a permanent waterproofing membrane that complies with local building codes.

STORAGE

Panels should always be stored in a dry, covered location prior to installation to protect them from moisture and damage.

IMPORTANT NOTES

- **Dissimilar metals:** Materials such as lead, copper, and other incompatible metals must not come into contact with Novatik products or leach onto them.
- **Treated lumber:** Do not use pressure-treated wood (decking or battens) in conjunction with Novatik products.
- **Fire-retardant chemicals:** Roof decks or battens treated with copper- or silver-based fire retardants are not compatible with Novatik panels.

CODE APPROVALS

Please consult your local **Authority Having Jurisdiction (AHJ)** to verify applicable codes, approvals, and additional requirements before installation. For official Novatik documentation — including technical reports and installation details — contact your Novatik representative.

CONSTRUCTION DETAILS

Underlayment: we recommend using high-temperature underlayment

Cutting Panels

Panels may be cut with a **cold-cut circular saw** or other non-abrasive cutting tools. Do not use abrasive blades, as they may damage the protective coating.

CODE APPROVALS

Before installation, confirm code compliance with your local **Authority Having Jurisdiction (AHJ)**. For official Novatik documentation — including evaluation reports and installation details — contact your Novatik representative.

EAVE FLASHING INSTALLATION

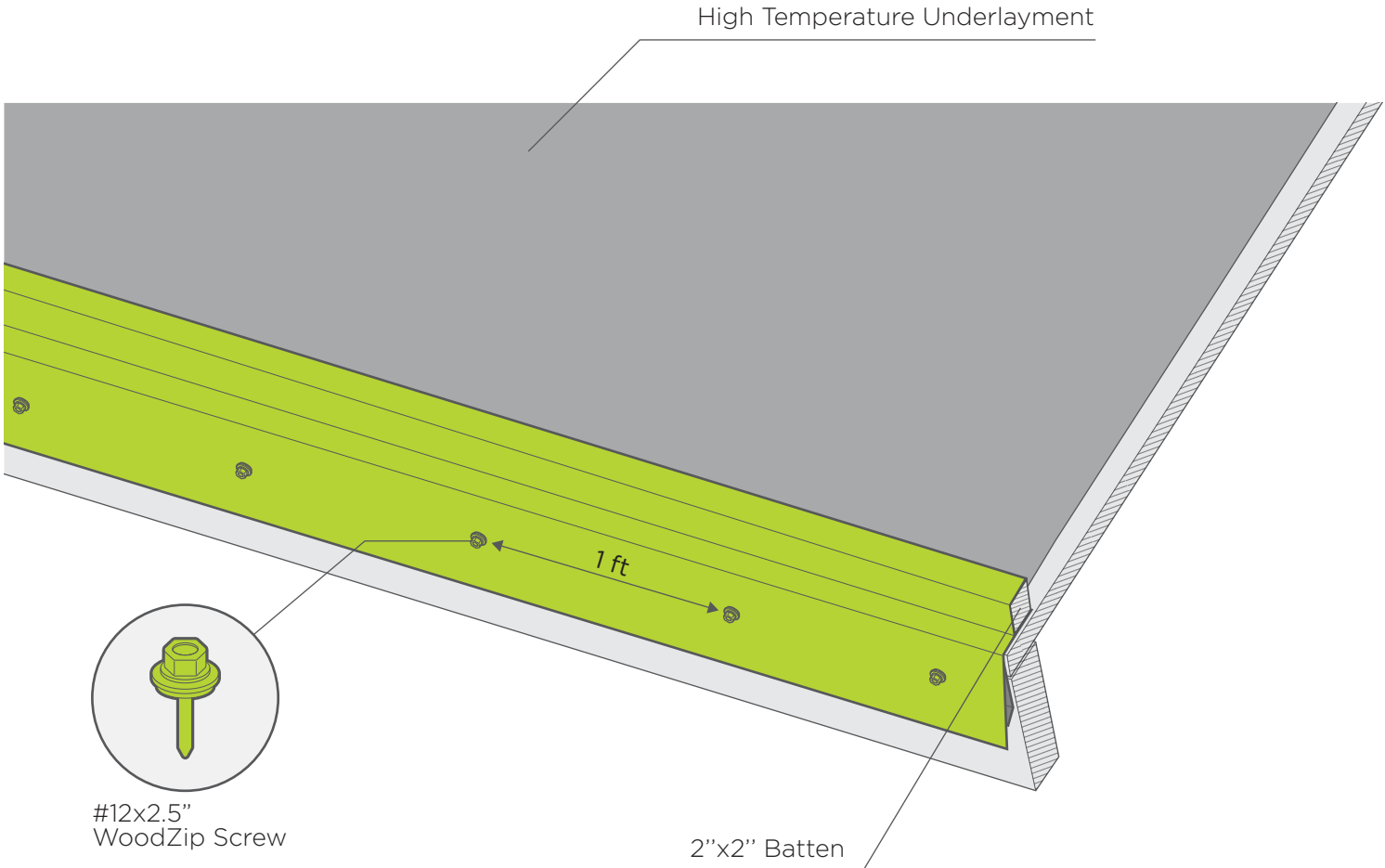

VALLEYS INSTALLATION

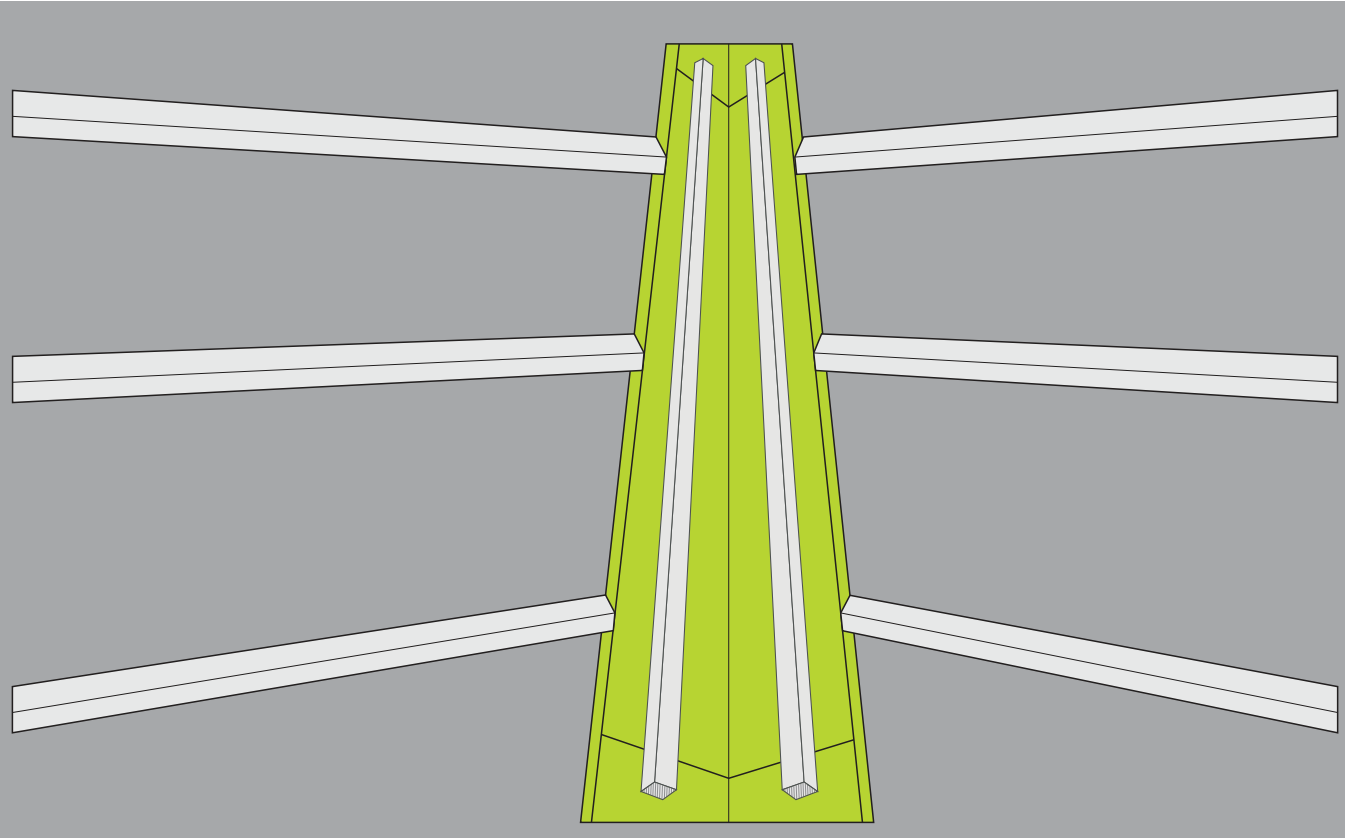

#12x2.5"
WoodZip Screw

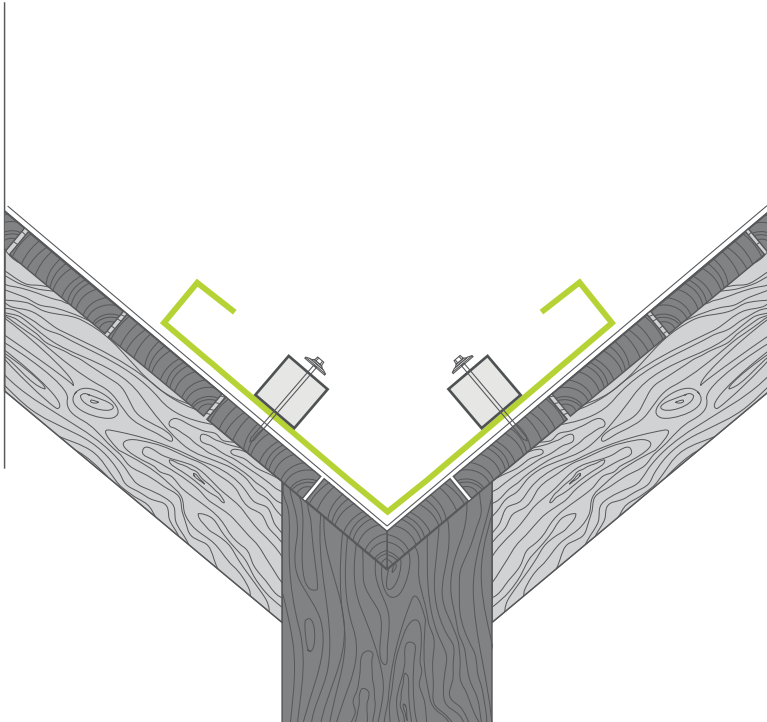

PANELS INSTALLATION

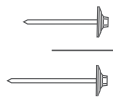
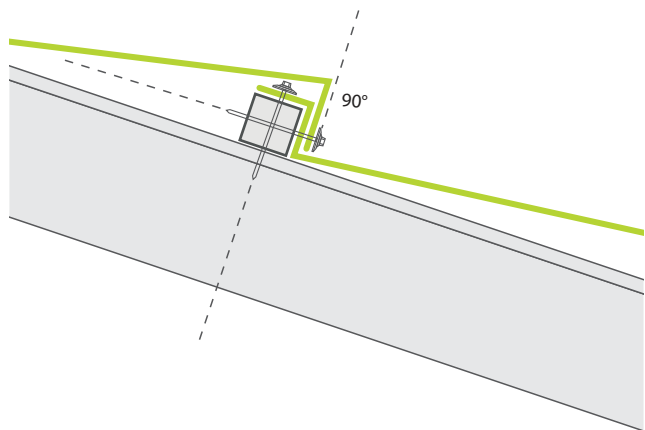
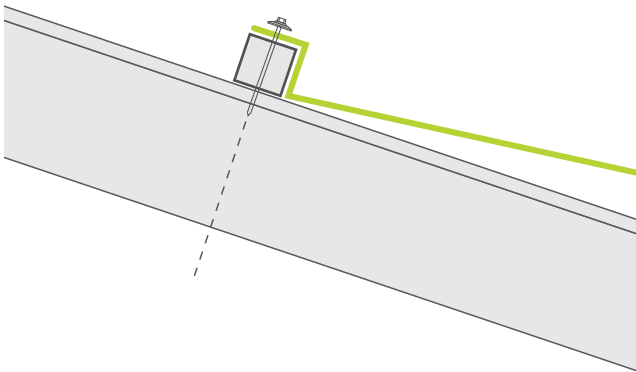
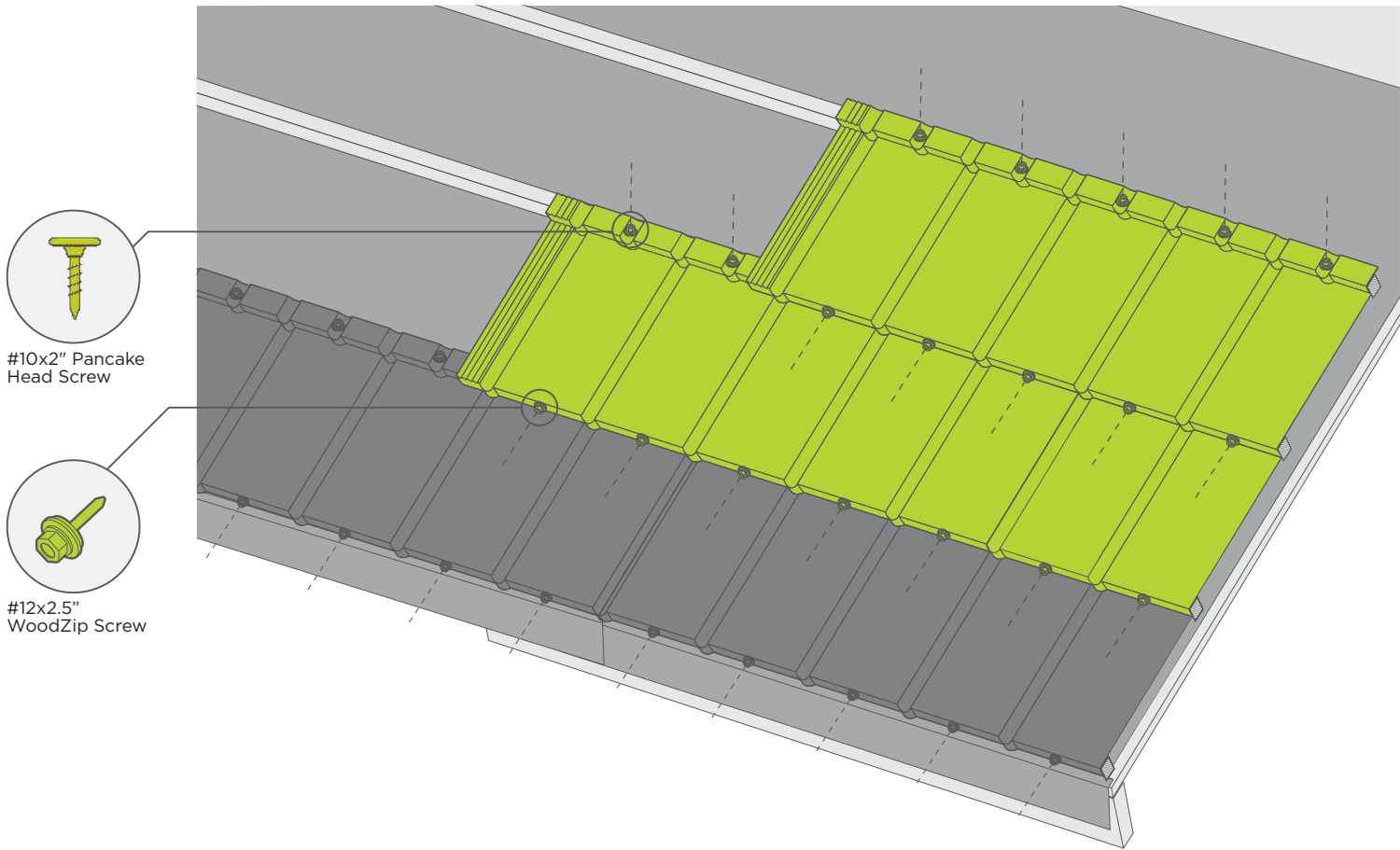

#10x2" Pancake Head Screw



#12x2.5" WoodZip Screw

HIPS + RIDGES INSTALLATION

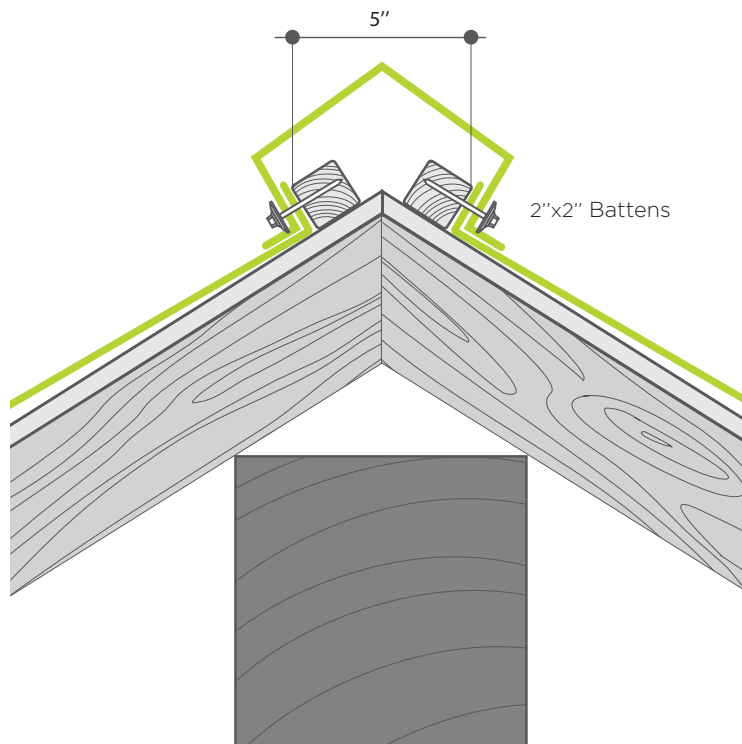
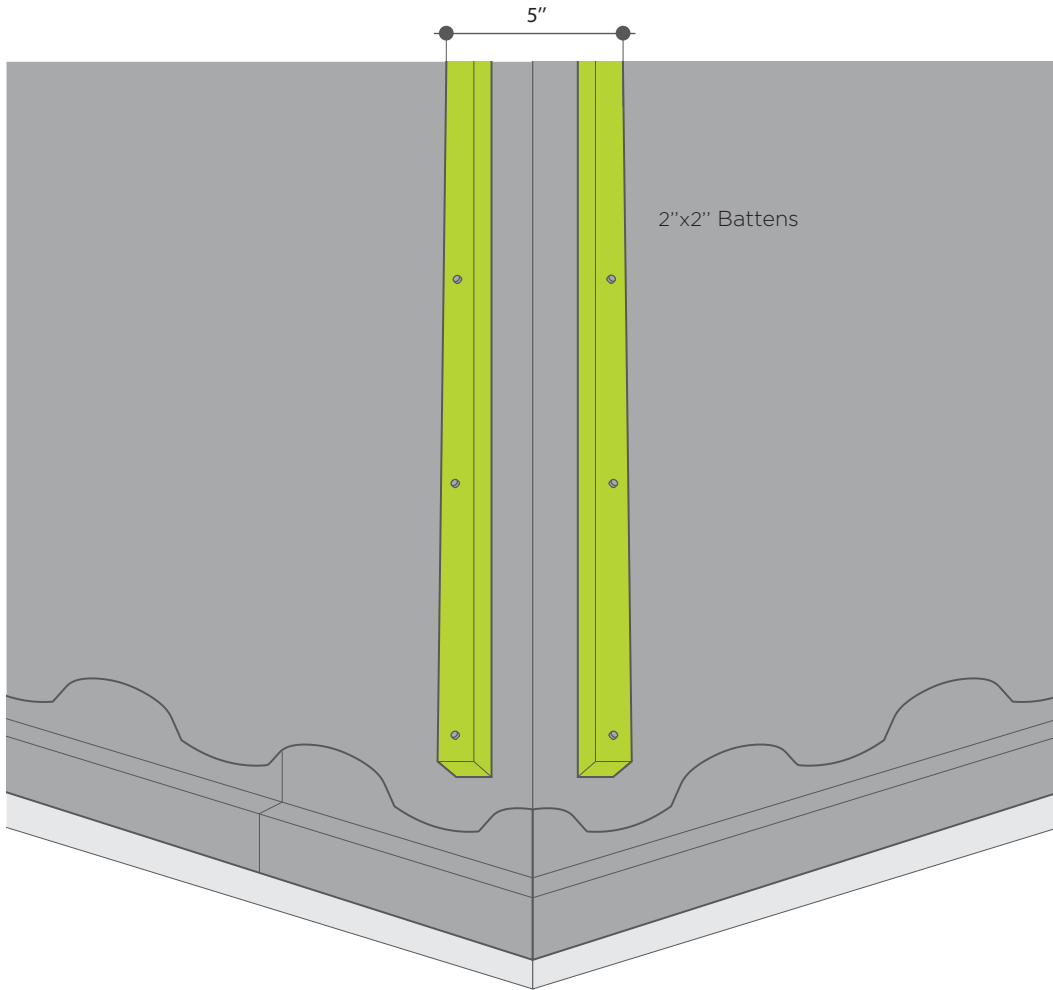

BOX BARGES INSTALLATION

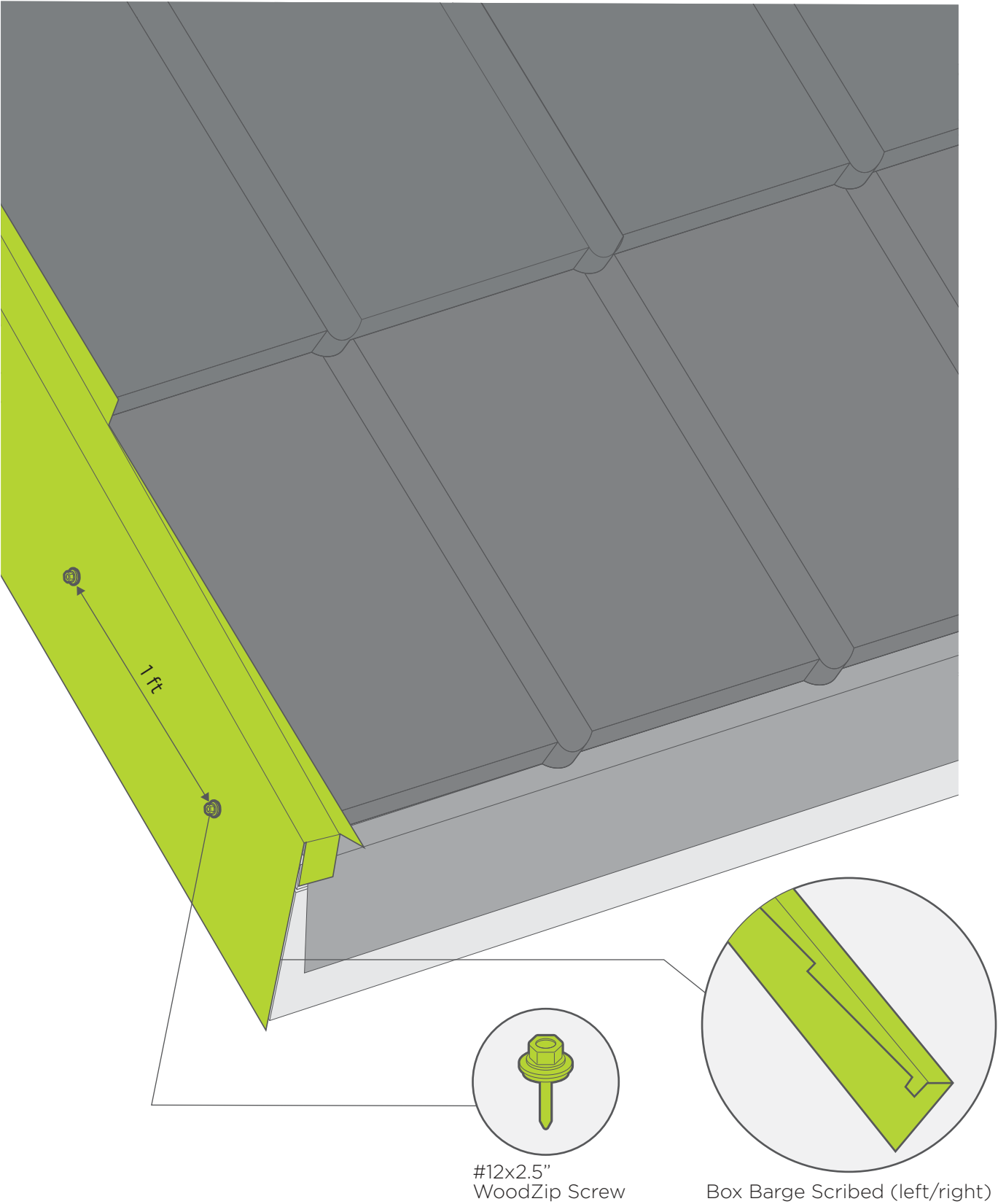

SIDE WALL FALSHING INSTALLATION

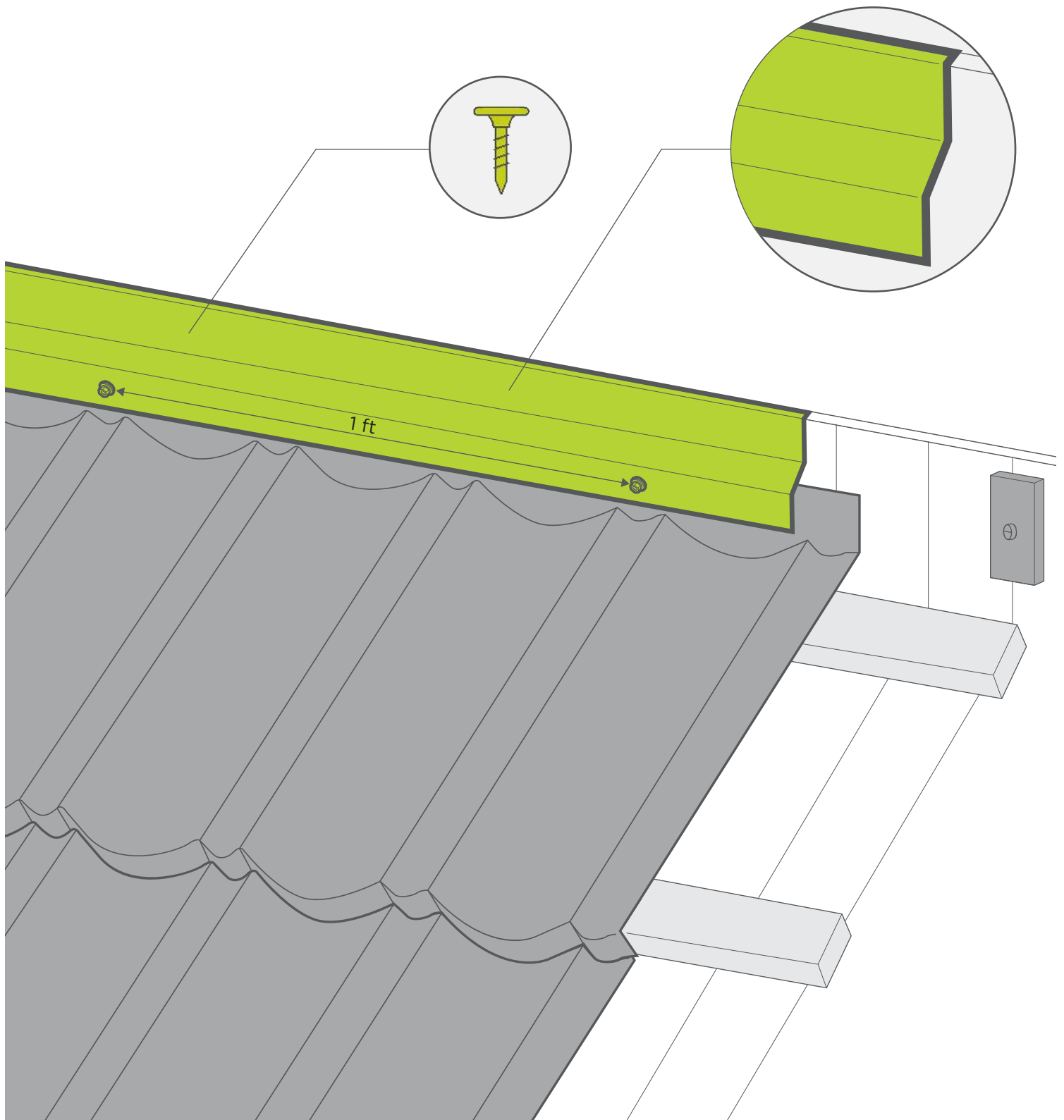

WALL FLASHING SCRIBED INSTALLATION

