



MALMERK KLAASIUM

Balcony Railings

PRODUCT CATALOGUE



Profile information

4

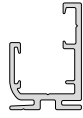

SPECIAL SOLUTIONS

MK Scandic

18



Fixing options

5



MK Vision profiles and fixings

20



MK Standard FF

6



MK Vision

21



MK Standard TF

8



System Edge & Aero fixings and profiles

22



MK Classic FF

10



System Edge

23



MK Classic TF

12



System Aero

24



SPECIAL SOLUTIONS

MK Standard DEC

14



French balconies

25



SPECIAL SOLUTIONS

MK Nordic

16



System components

27





Malmerk Klaasium offers wide variety of balcony railings. We design and produce the solution-oriented railings according to customer needs. Our up-to date processes, experts and long experience guarantees a well-functioning custom, secure and long-lasting solutions.

Our mission

Transforming outdoor areas into practical, safe, useful and valuable extra spaces.

Our vision

To be the preferred partner offering glass aluminium balcony and terrace products in the Nordic-Baltic countries.

Our values

Reliable
Forward-thriving
Solution-oriented
Honest & caring



General information

Malmerk Klaasium has designed a railing system in a way that it is possible to mix and match different profiles to create various looks. Our balcony glazing system has been taken into consideration when designing the railing system and therefore the railing system fits perfectly for our balcony glazing system.

Customizable design

Railings are tailor made and customized based on customer needs - measures, colours, materials and configurations.

Quality materials and controlled processes

Aluminum profiles and specific components are designed in-house and supplied by quality suppliers.

In-house engineering and production.

Railing modules are premade and delivered ready assembled, ready for installation on site.

Common design line

Safety glass or other fillings (e.g. high pressure laminate or fibre cement sheets) can be used as a filler. All plastic components and gaskets are black (RAL9005).

Profile information

Handrails

All our handrail profiles can be combined depending on the desired railing solutions. Profile names are in red, profile codes are in blue.

PR20-02 **KP2-50**

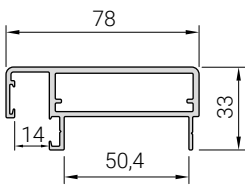

PR20-01 **KP1-50**

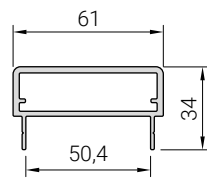

PR20-04 **KP2-70**

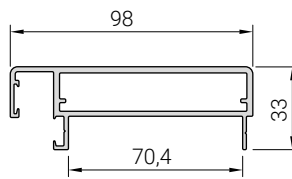

PR20-03 **KP1-70**

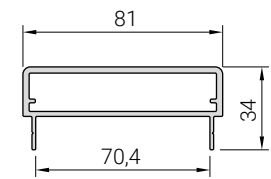

PR20-24 **KP5-50**

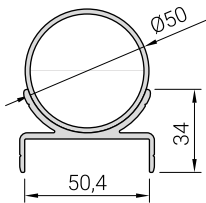

PR20-22 **KP5-70**

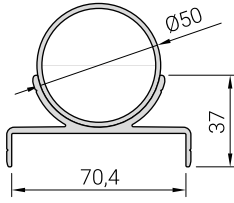

PR20-05 **KP3-70**

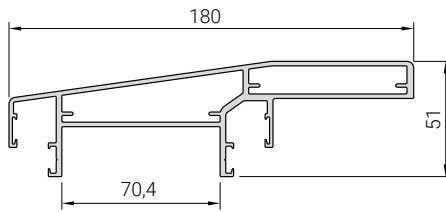

Handrail **KP3-70** can be used for enhanced wind resistant properties and for inward mounted balcony glazing system.

Filling profiles

PR20-10

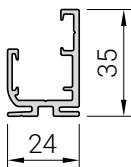

PR20-11

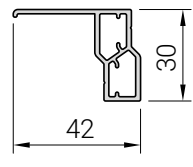

PR20-06

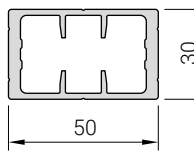

PR20-07

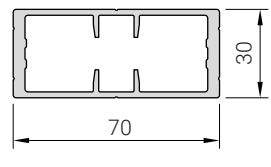

PR20-14

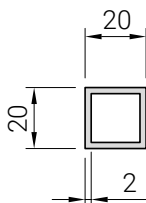

SURFACE TREATMENT
Powder coated

COLOUR CHART
RAL

Extras

PR20-16

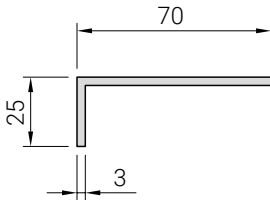

PR40-69

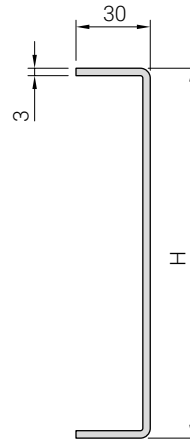
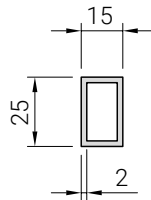

C-profile covering the face of the balcony slab.

Fixing options

Front fixing aluminium brackets

For 50 mm pillar
SK20-0029

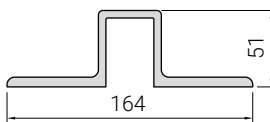

For 70 mm pillar
SK20-0030

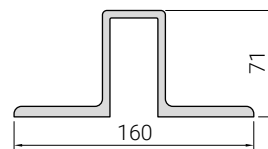

Top fixing steel brackets

For 50 mm pillar
SK20-0031

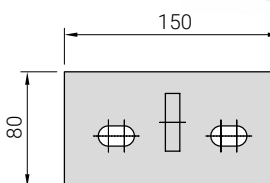

For 70 mm pillar
SK20-0032

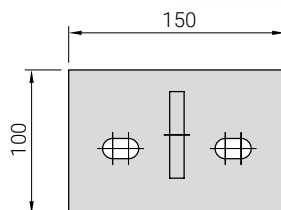

For 70 mm pillar
SK20-0041

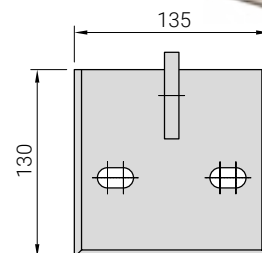

A top fixing bracket **STF** allows to install glass in front of the balcony slab.

MK Standard FF



Glass-aluminium railing: front fixed

System MK Standard FF gives a wide variety of design options to find a perfect modern solution.

Glass or other fillings are installed inside or outside of the pillars without vertical profiles.

- | | |
|---|----------------------|
| 1 | Handrail profile |
| 2 | Glass profile |
| 3 | Pillar |
| 4 | Gap profile |
| 5 | Filling* |
| 6 | Front fixing bracket |
| 7 | C-profile |

* most popular choice of filling is glass; various composite boards e.g. Cembrit, Vivix can be used as an alternative

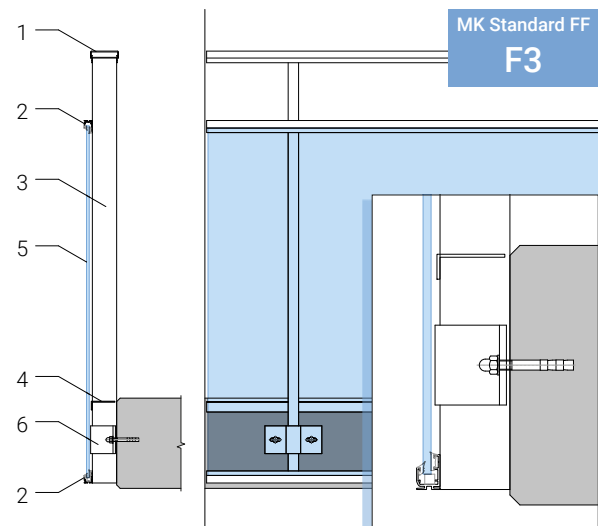
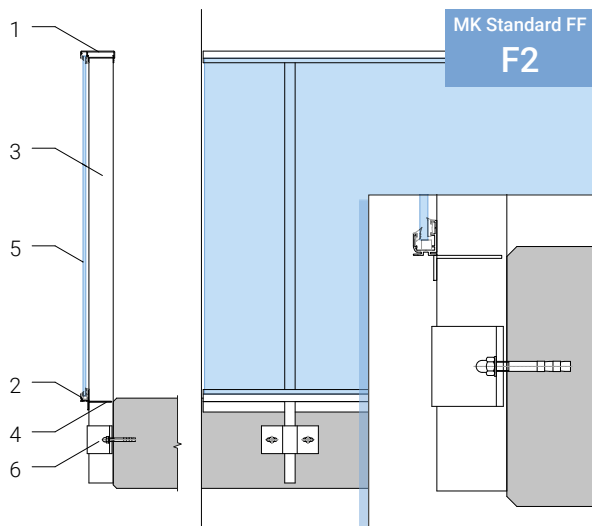
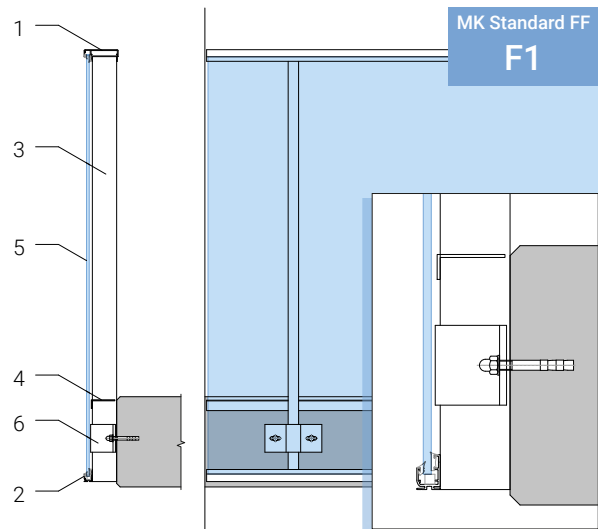

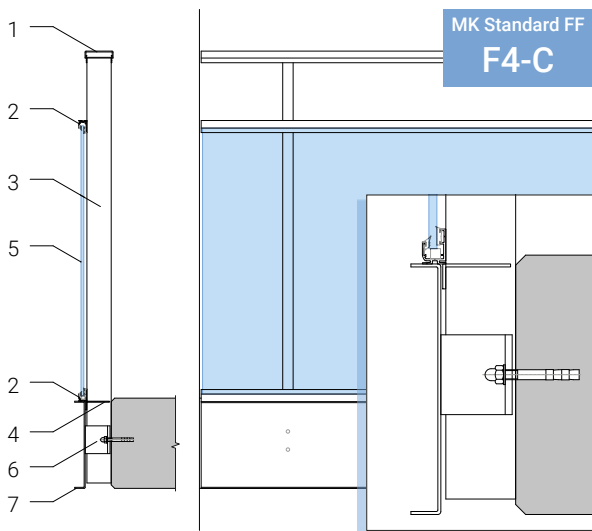
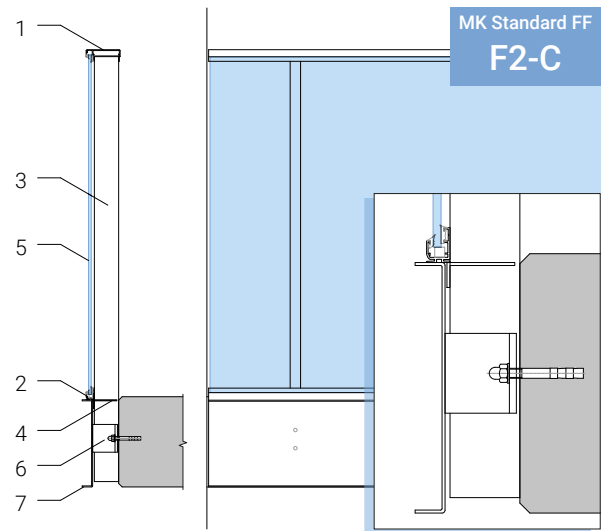
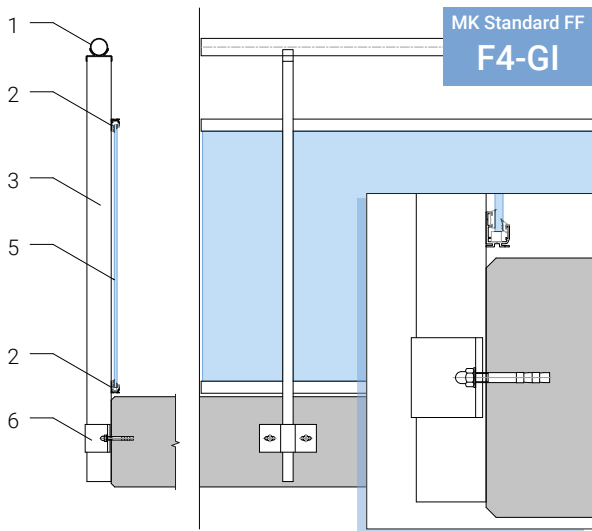
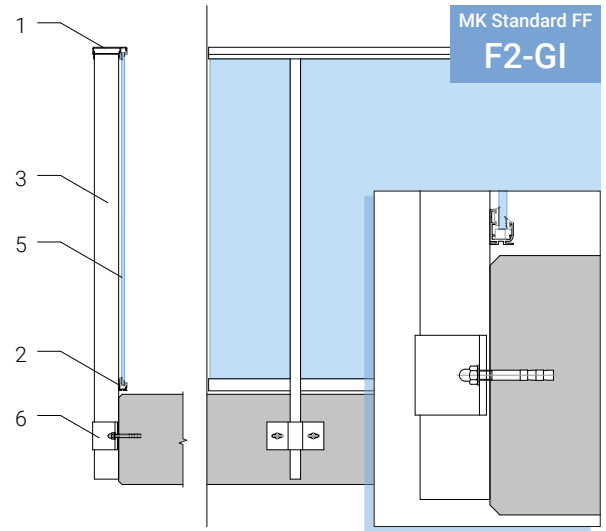
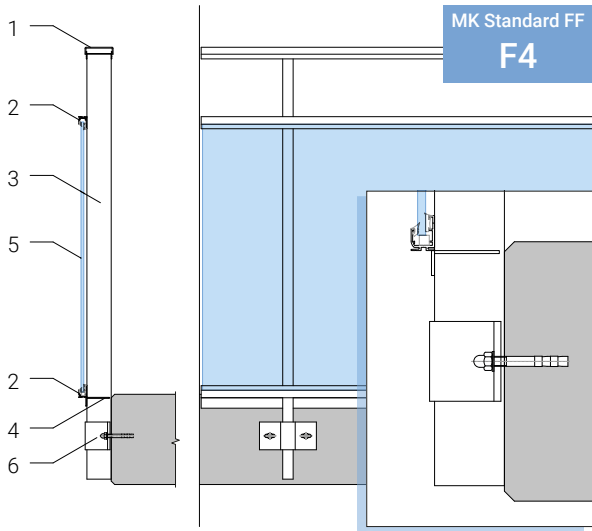

MK Standard TF

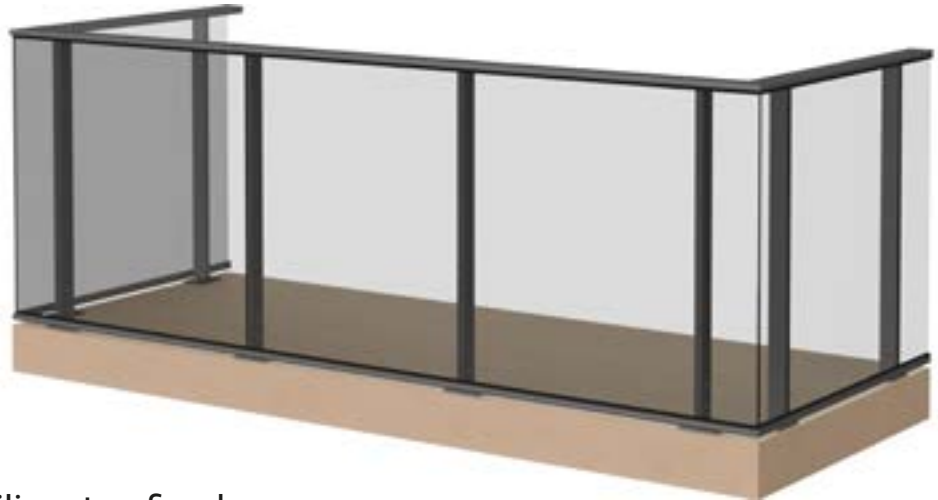

Glass-aluminium railing: top fixed

System MK Standard TF gives several design options to find a perfect modern solution.

Glass or other fillings are installed inside or outside of the pillars without extra vertical profiles.

1	Handrail profile	* most popular choice of filling is glass; various composite boards e.g. Cembrit, Vivix can be used as an alternative
2	Glass profile	
3	Pillar	
5	Filling*	
6	Top fixing steel bracket	
2		

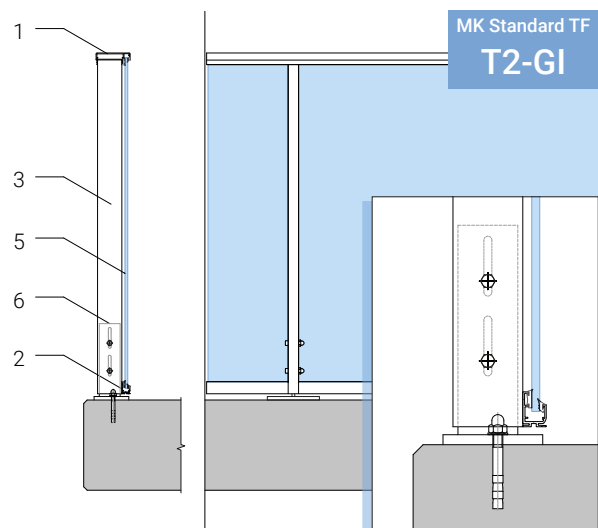
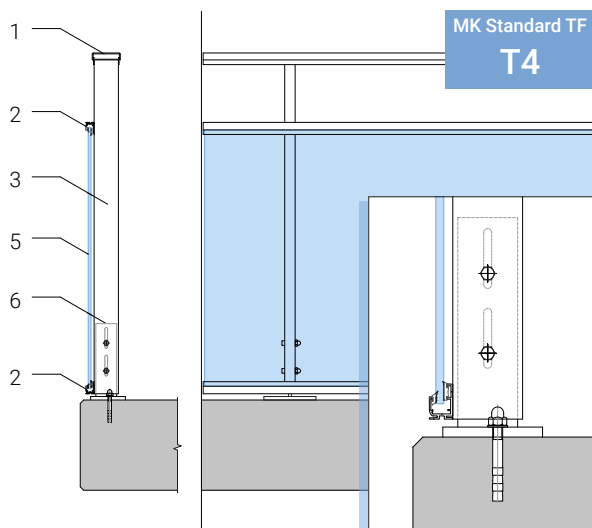
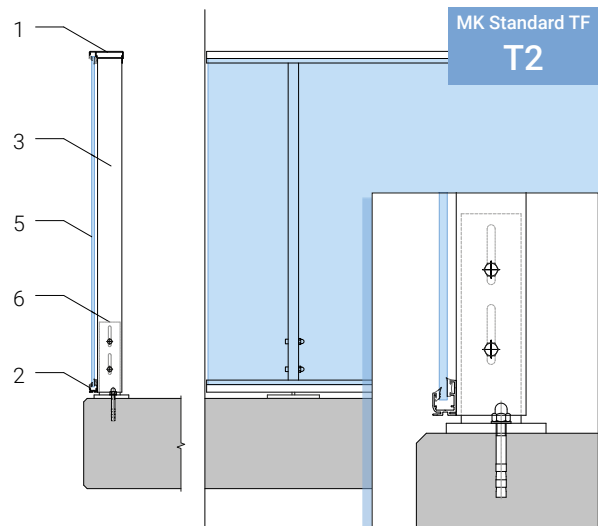

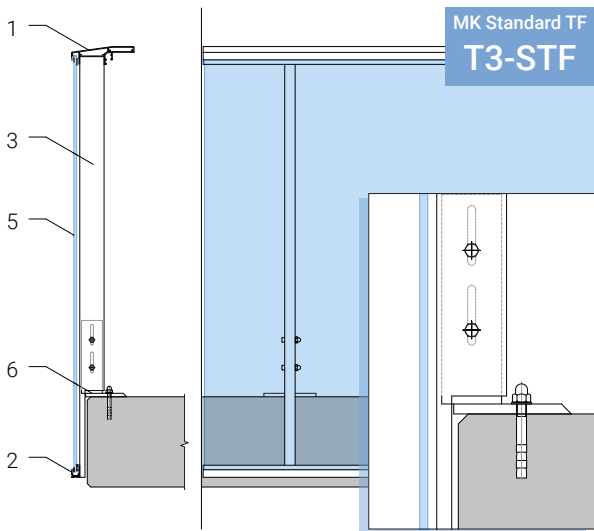
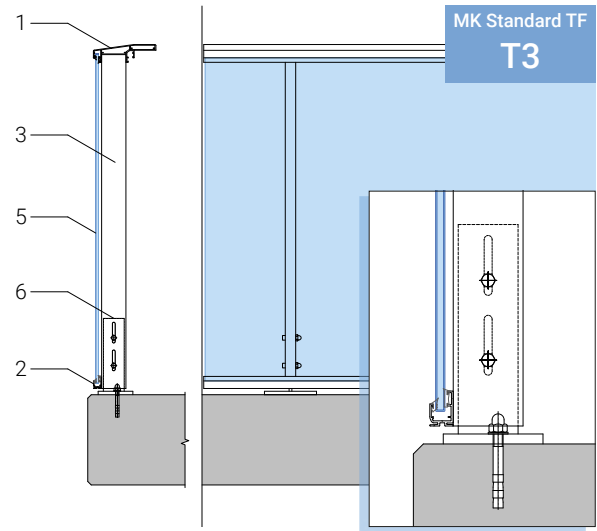
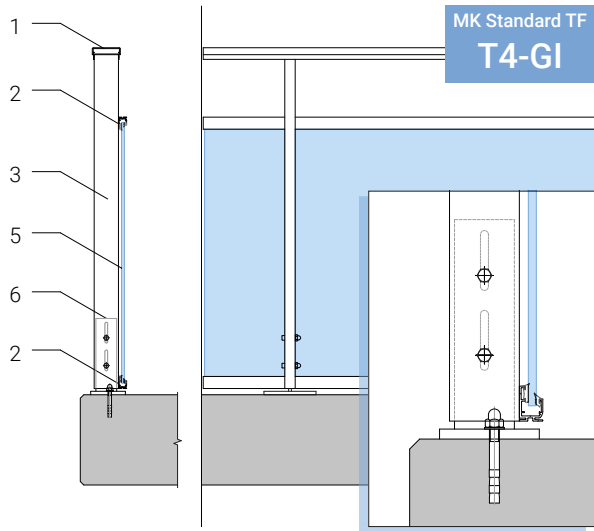

MK Classic FF



Aluminium rod railing: front fixed

System MK Classic FF is a light weight solution making it easy to work with.

Rods are installed inside or outside of the pillars.

1	Handrail profile
3	Pillar
6	Front fixing bracket
7	C-profile
8	P-profile
9	Rods

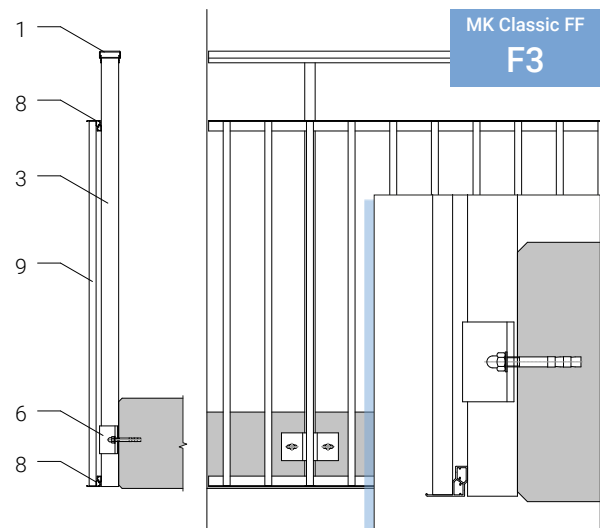
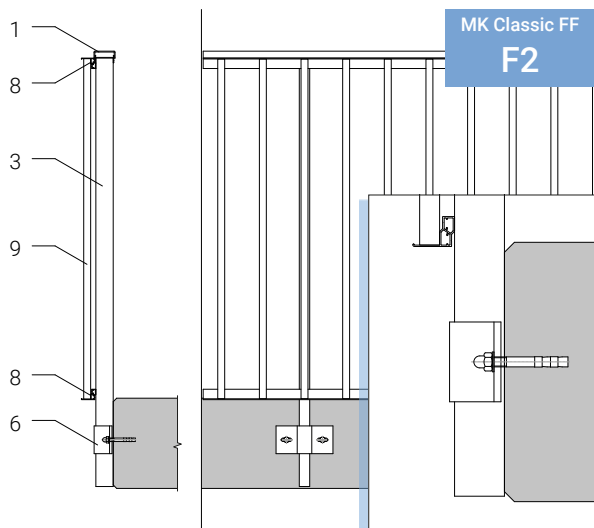
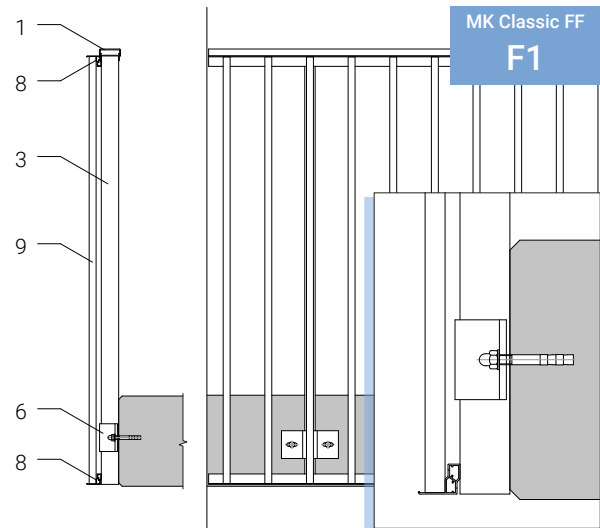

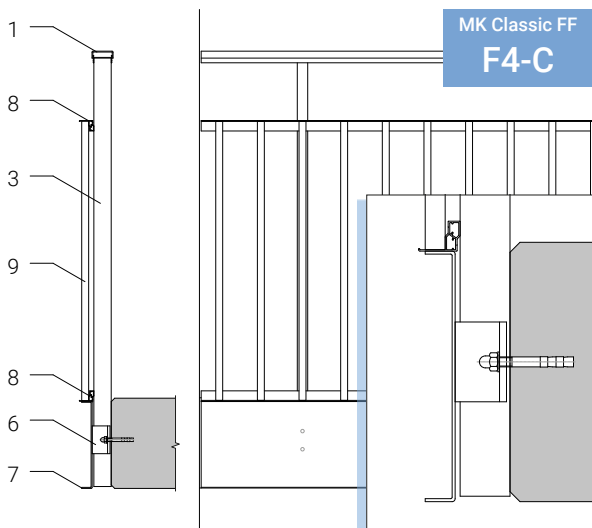
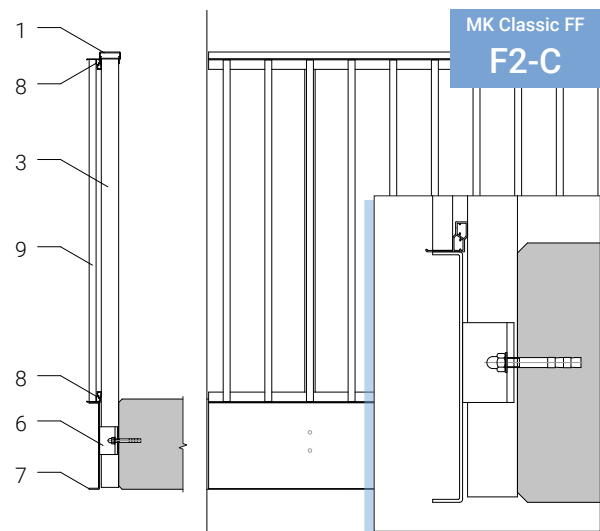
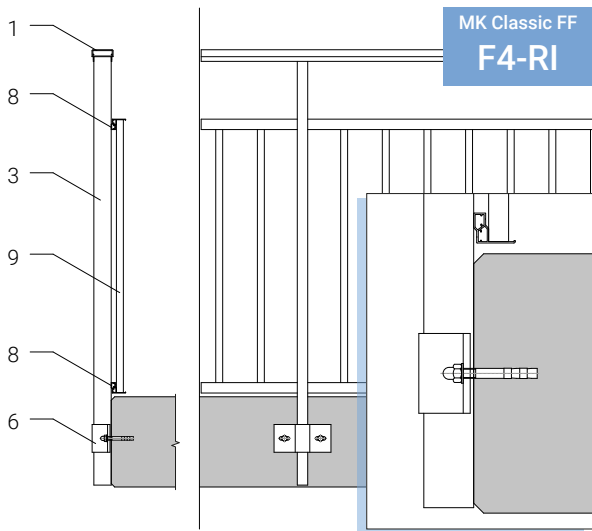
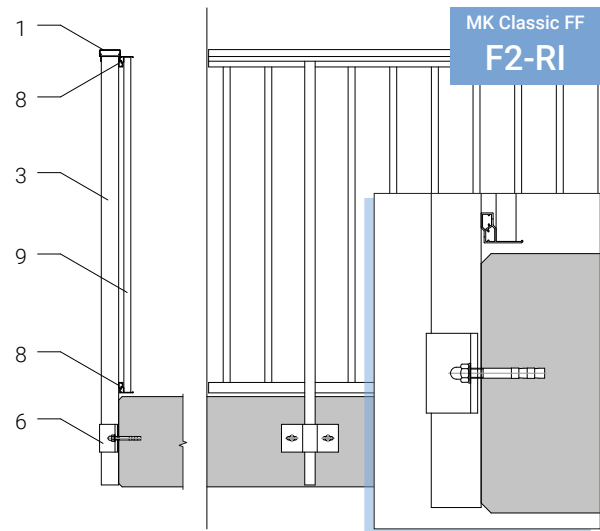
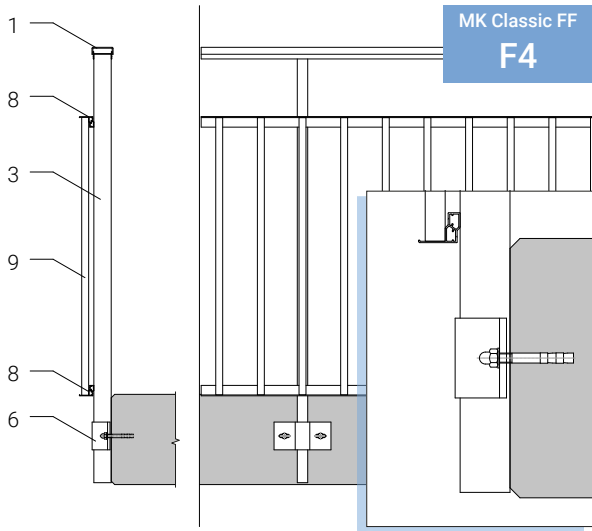

MK Classic TF



Aluminium rod railing: top fixed

System MK Classic TF is a light weight solution making it easy to work with.

Rods are installed inside or outside of the pillars.

1	Handrail profile
3	Pillar
6	Fixing profile
8	P-profile
9	Rods

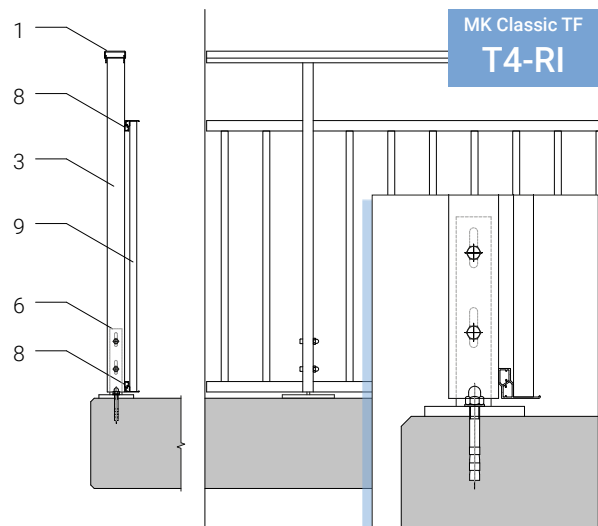
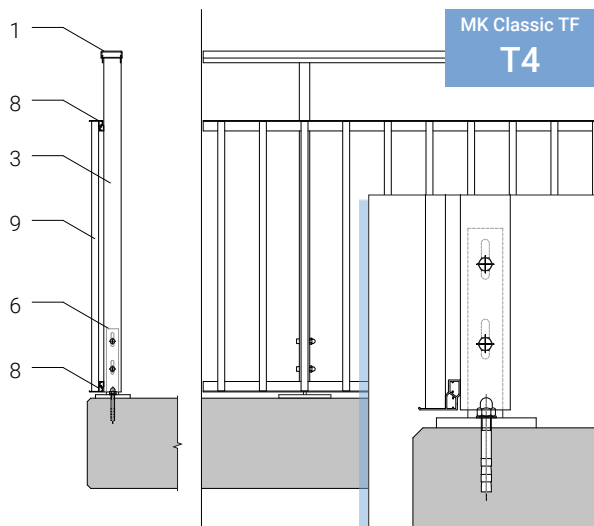
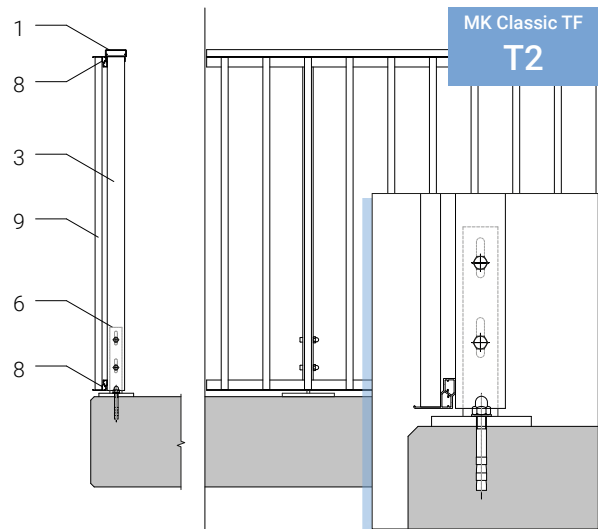

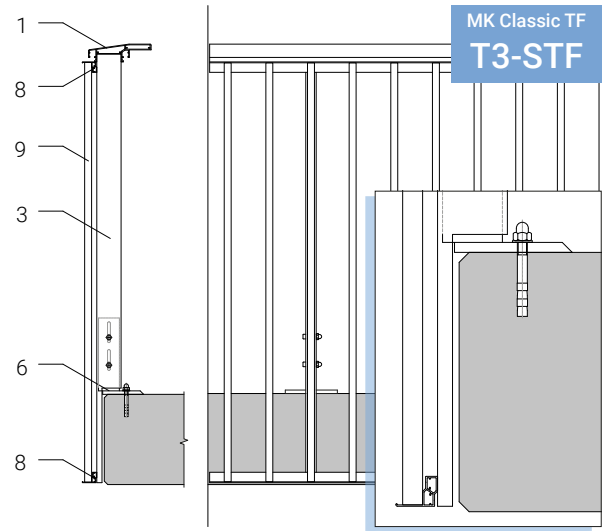
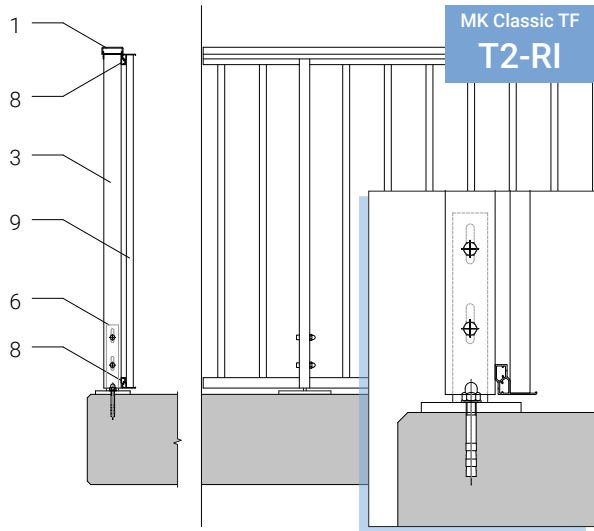

MK Standard DEC



Glass-aluminium railing with horizontal decorative profiles

System MK Standard DEC is further development of system MK.

Glass or other fillings are installed inside of the pillars without vertical profiles and horizontal decorative profiles installed outside of the pillars.

1	Handrail profile	
2	Glass profile	
3	Pillar	
5	Filling*	* most popular choice of filling is glass; various composite boards e.g. Cembrit, Vivix can be used as an alternative
6	Front or top fix bracket	
10	Decorative profile	

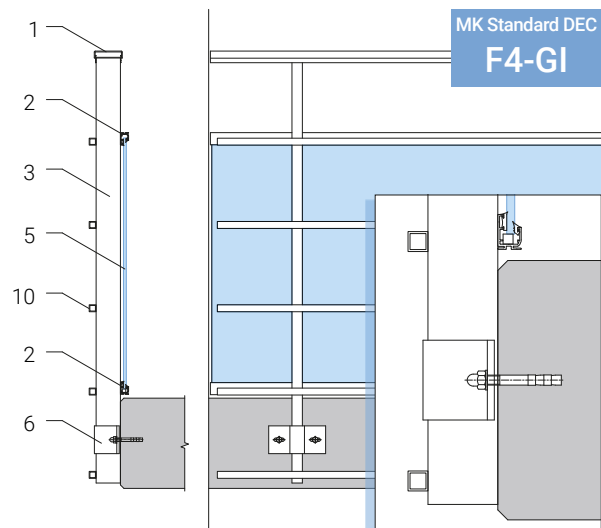
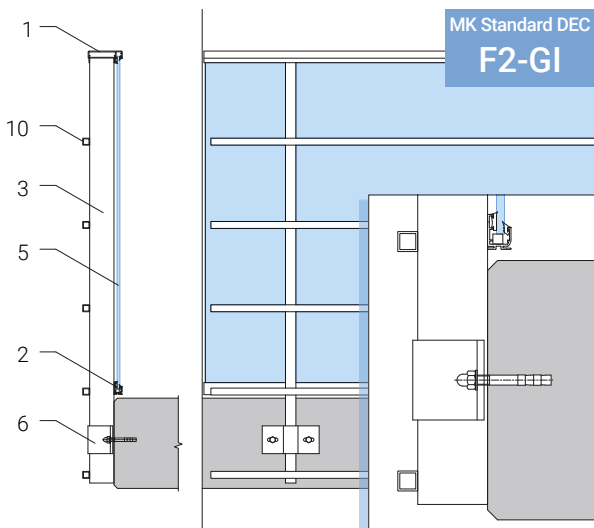

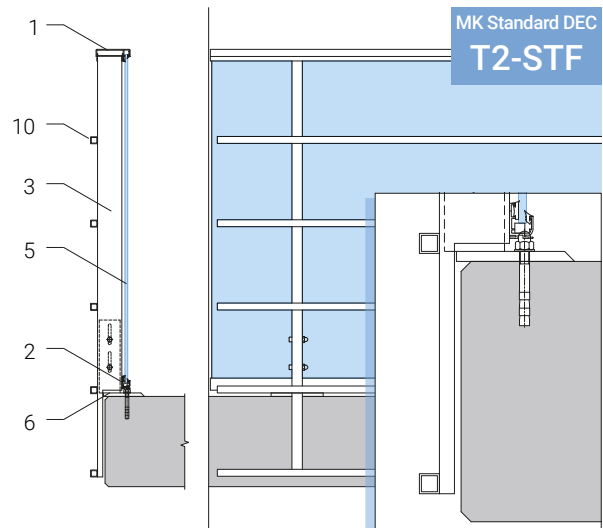
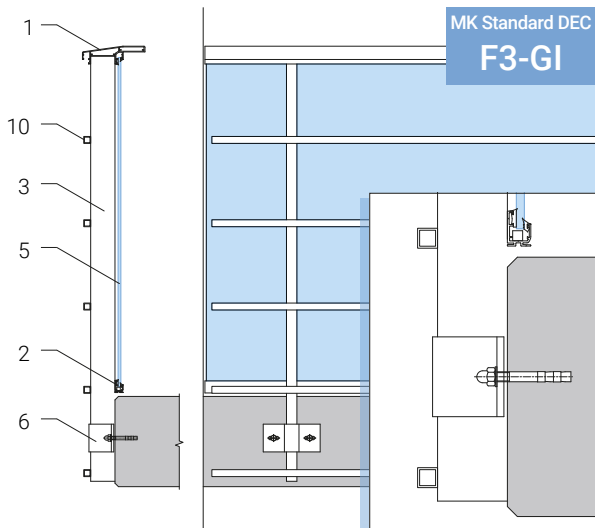
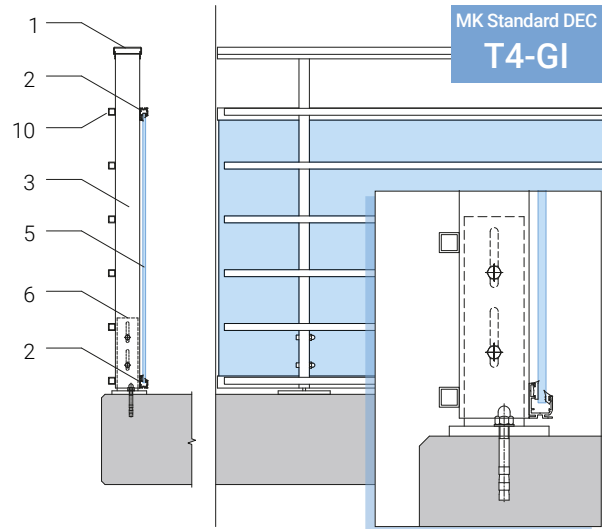
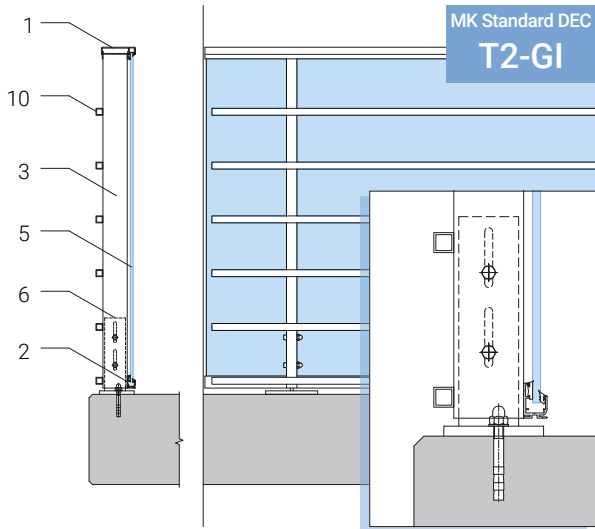

SPECIAL SOLUTIONS

MK Nordic



Glass-aluminium railing with clamps

System MK Nordic is a simple solution that has a lot of different possibilities.

Glass is installed between the pillars with stainless steel glass clamps.

- | | |
|----|-----------------------------|
| 1 | Handrail profile |
| 3 | Pillar |
| 5 | Filling |
| 6 | Front or top fixing bracket |
| 7 | C-profile |
| 12 | Glass clamp |

45x45 mm stainless steel
SK20-0037

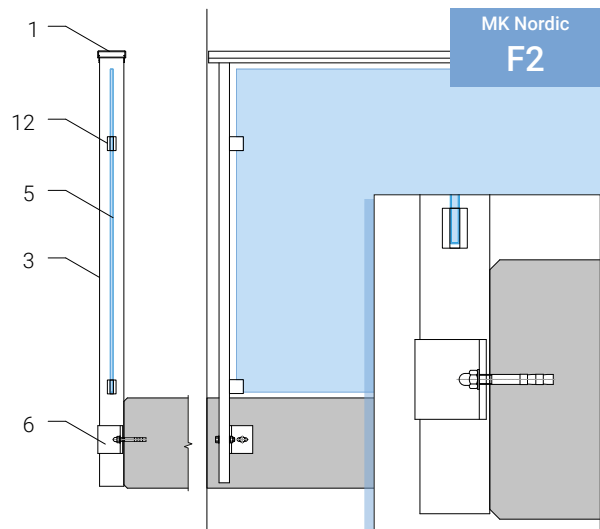
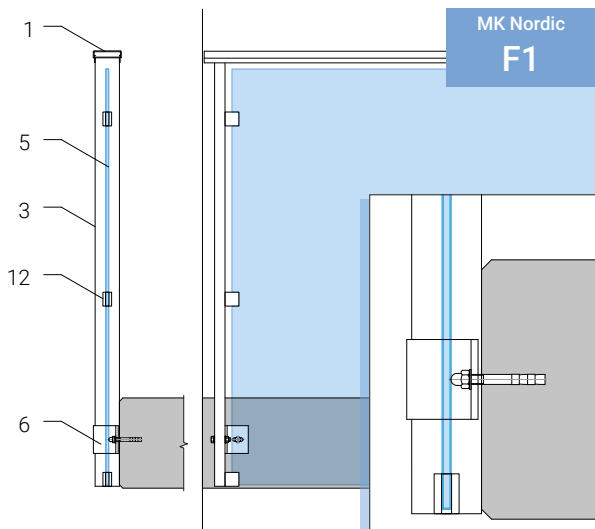
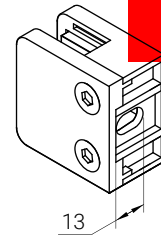
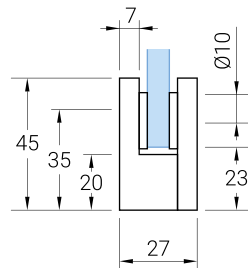

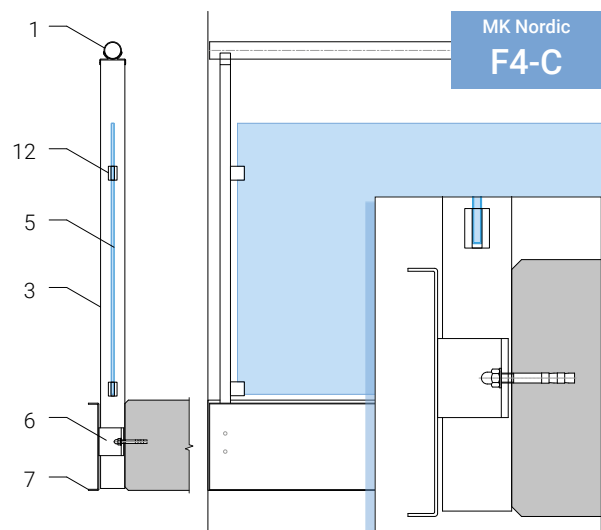
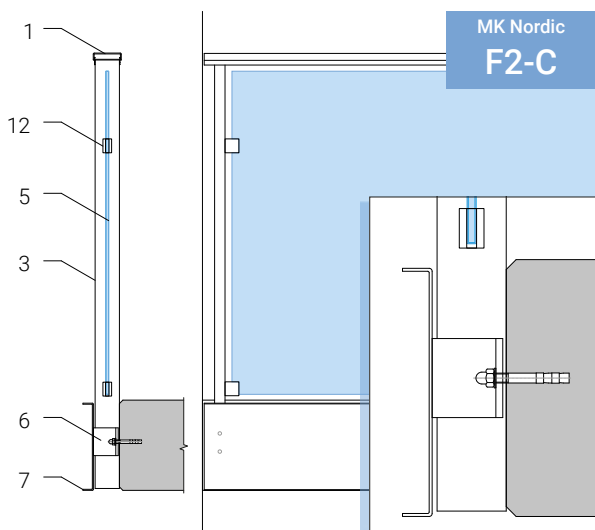
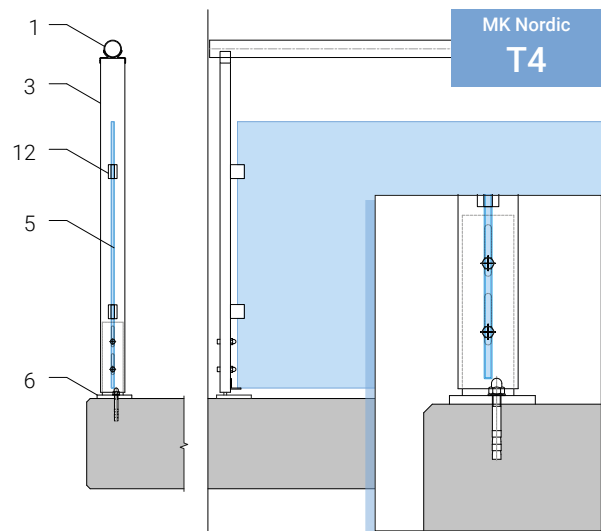
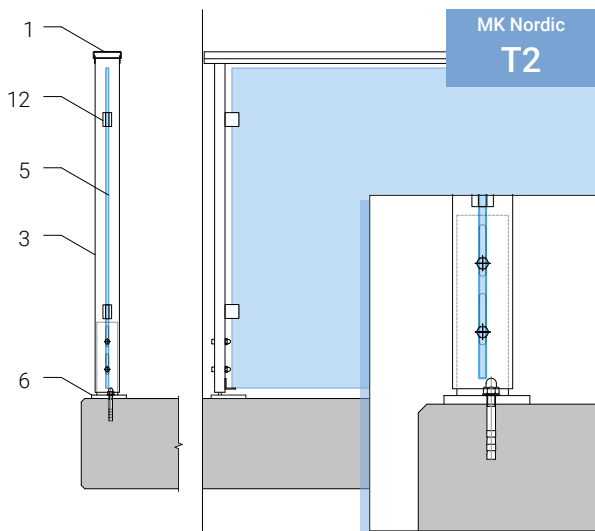
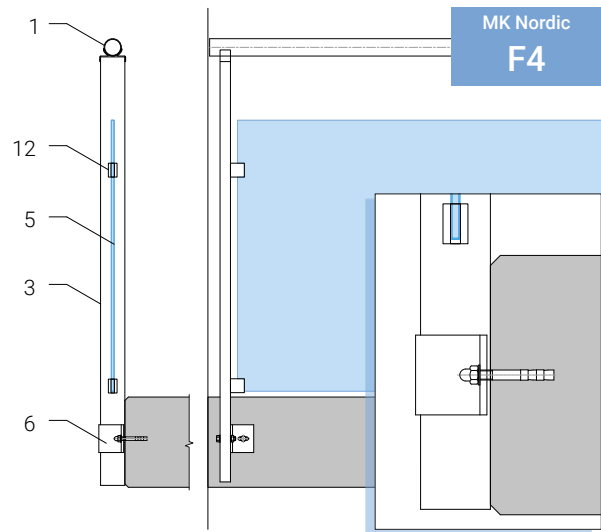
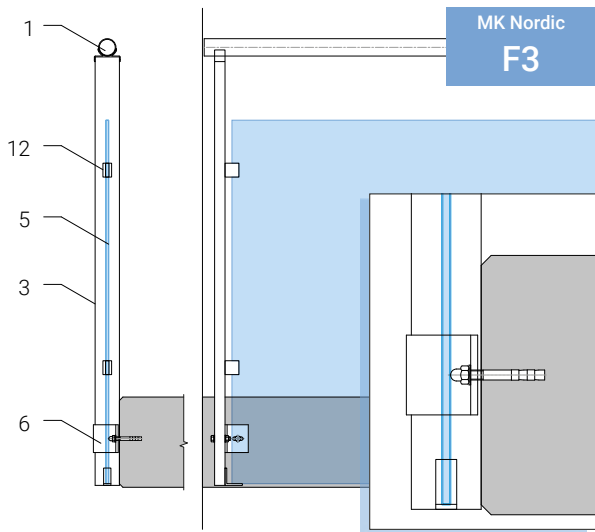

SPECIAL SOLUTIONS

MK Scandic



Aluminium railing with various sheet metals and composite boards

System MK Scandic gives a lot of privacy to the balcony.

Corrugated metal sheets and composite board can be installed inside or outside of the pillars.



- | | |
|----|----------------------|
| 1 | Handrail profile |
| 3 | Pillar |
| 4 | Gap profile |
| 5 | Filling* |
| 6 | Front fixing bracket |
| 8 | P-profile |
| 13 | Support profile |

* Various metal sheets and composite boards e.g. trapezoidal sheets, perforated sheets, Cembrit, Vivix etc.

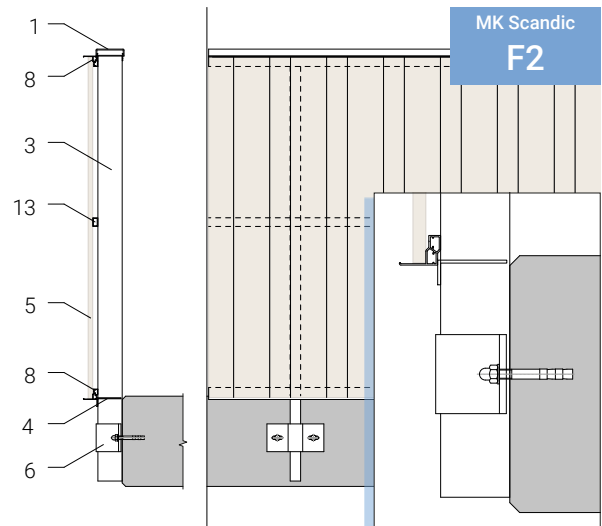
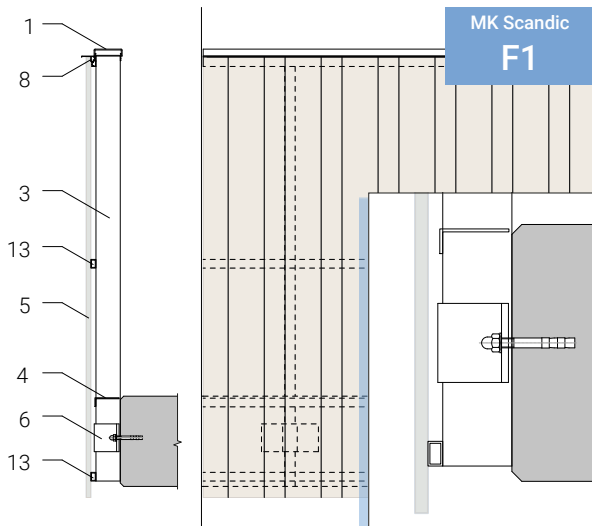

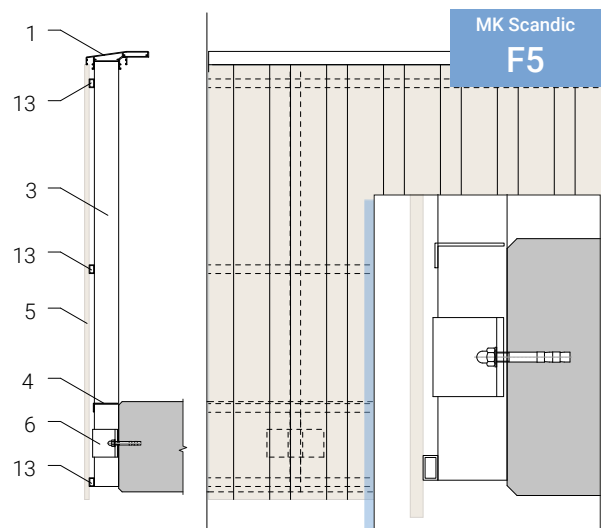
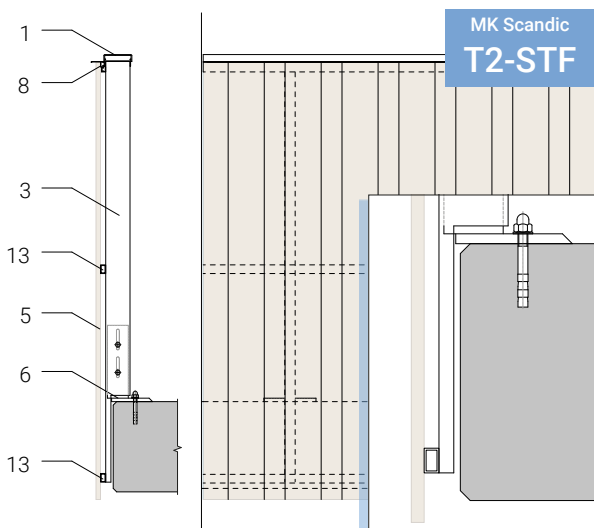
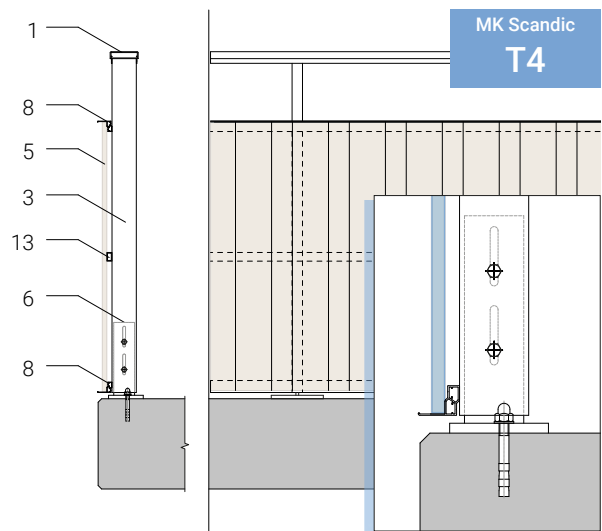
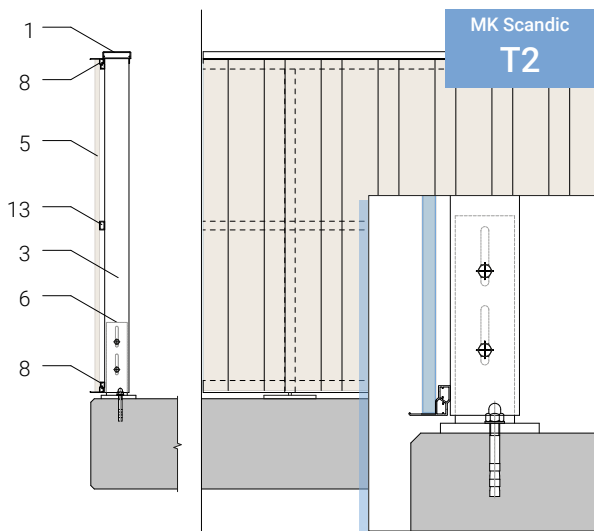
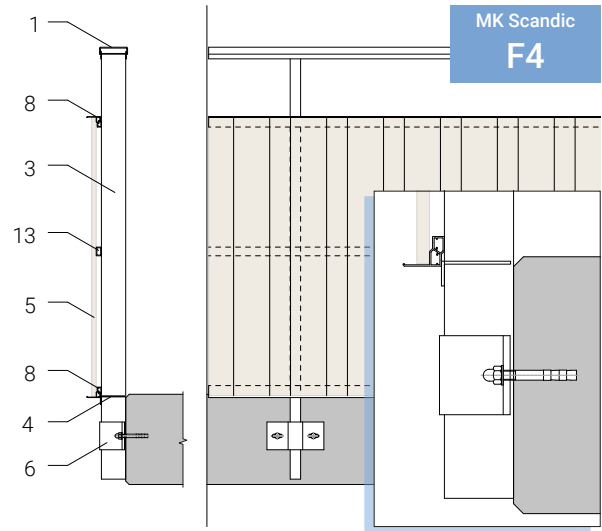
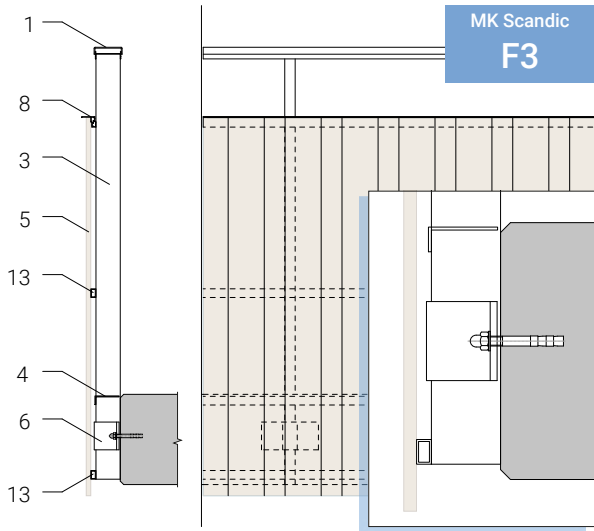

MK Vision profiles and fixings

Fixing profile

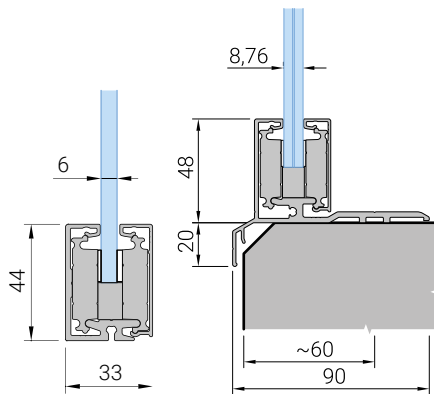

GLASS THICKNESS / SHAPE

6	PR40-128	PR40-141
8	PR40-129	PR40-142
10	PR40-131	PR40-144
12	PR40-133	PR40-146
33.1	PR40-128	PR40-141
44.1	PR40-129	PR40-142
44.2	PR40-130	PR40-143
55.1	PR40-131	PR40-144
55.2	PR40-132	PR40-145
66.1	PR40-133	PR40-146
66.2	PR40-134	PR40-147

Pillar

SK20-0047

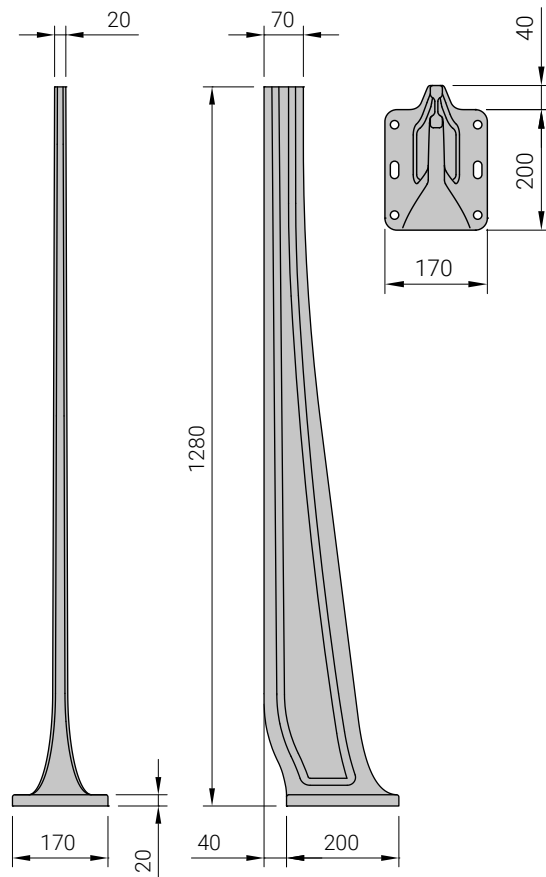

SURFACE TREATMENT

Powder coated

COLOUR CHART

RAL

MK Vision

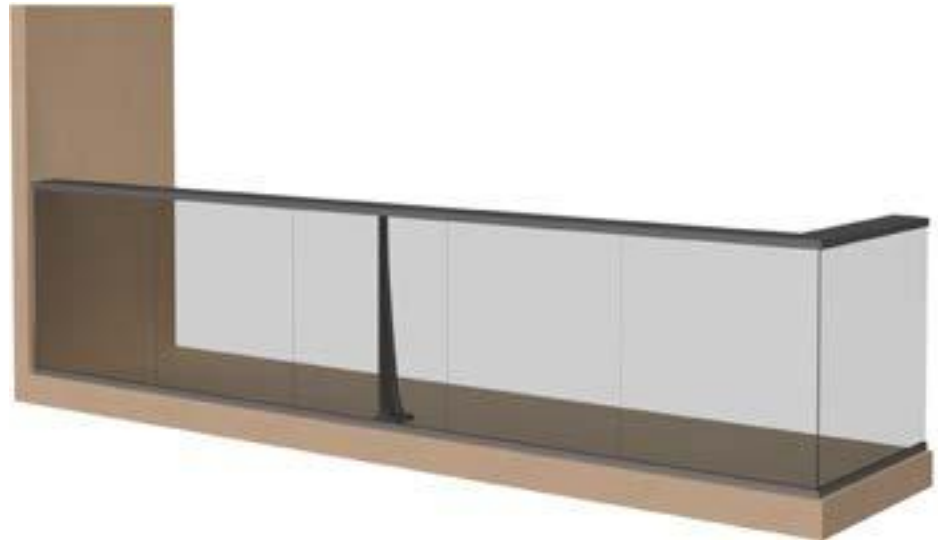

Glass-aluminium railing

System MK Vision makes it possible to install balcony glazing on top of a full glass railing with handrail.

Streight calculations must be performed by qualified engineer.

1	Handrail profile
5	Glass filling
14	Clamp profile

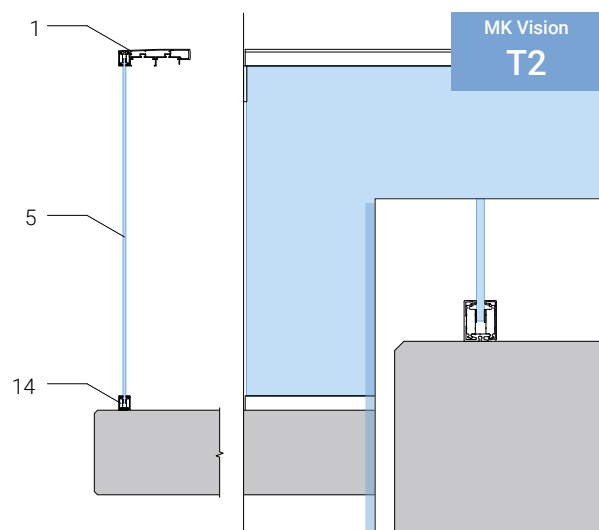
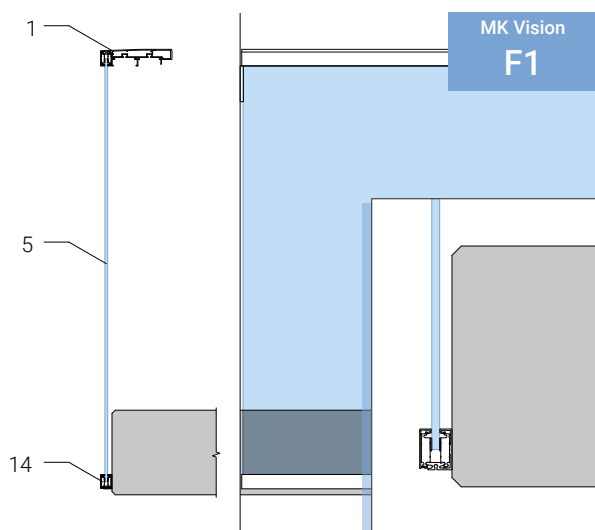

System Edge & Aero fixings and profiles

Point fixings

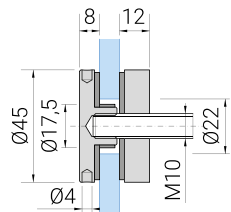
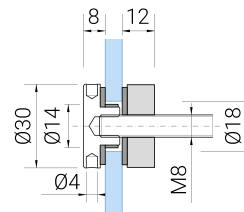
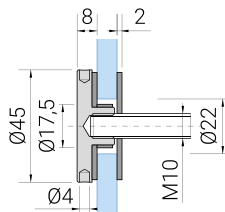
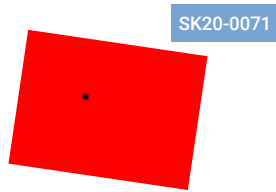
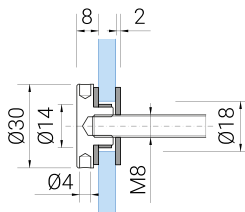

Adjustable glass railing profiles

GPR 1,5 K/N top fixed

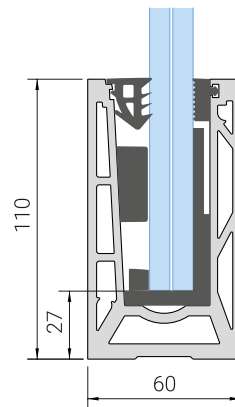
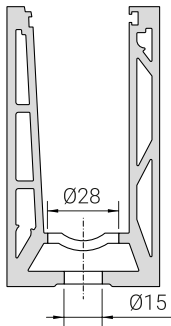

Slot tube

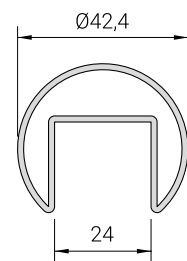

SURFACE TREATMENT

Satin, brushed

GPR 1,5 K/N front fixed

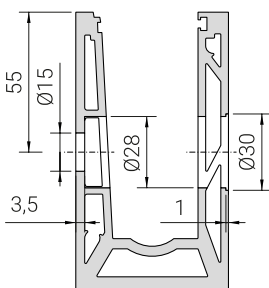

System Edge

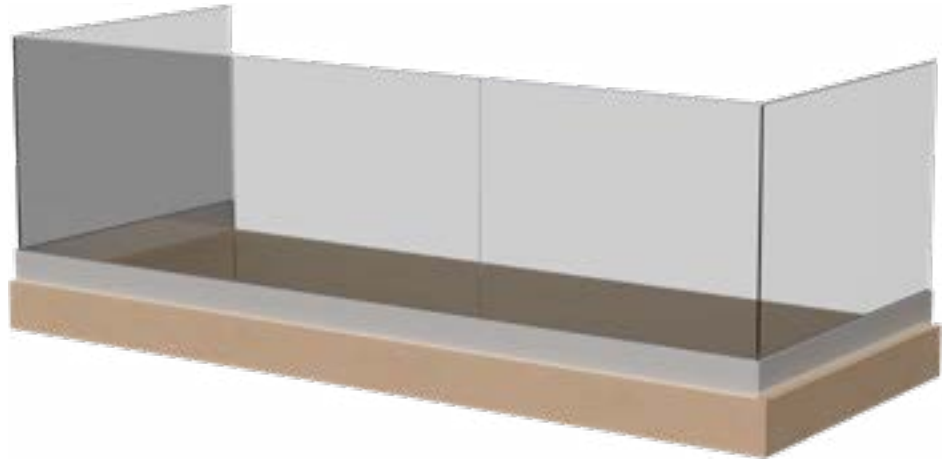

Full glass railing with bottom profile

System Edge has no pillars disturbing the view.

Glass is installed with bottom profile on top or to the side of the balcony plate.

This system must be installed with a PR20-21 handrail when the railing is more than 600 mm high and more than 8 m wide.

1	Handrail profile
5	Glass filling
11	Fixing profile

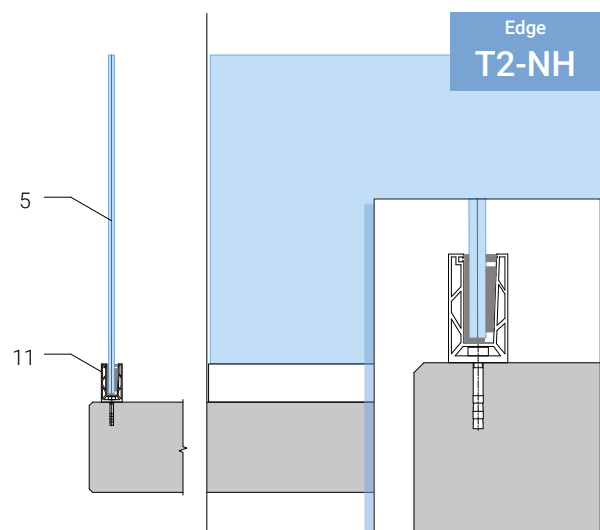
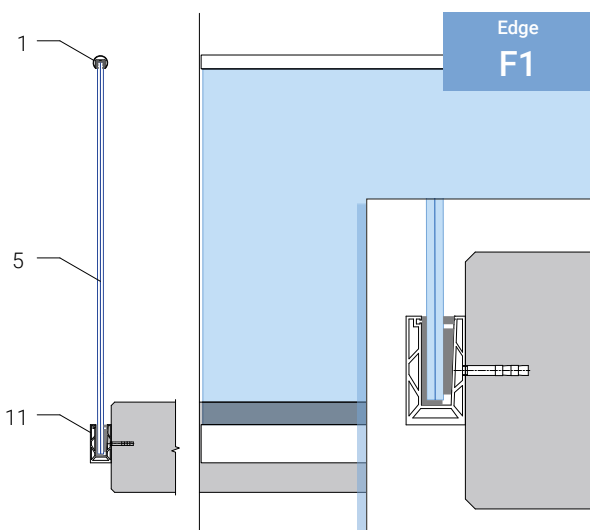
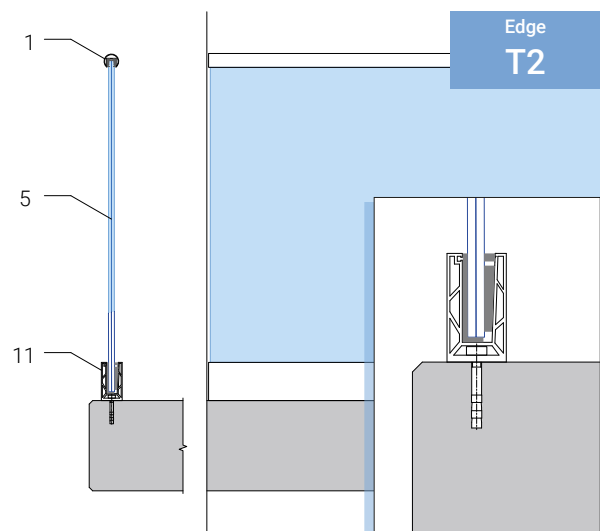

System Aero



Full glass railing with point fixings

System Aero has no pillars disturbing the view.

Glass is installed with stainless steel point fixings to the side of the balcony plate. Can be with or without handrail.

1	Handrail profile
5	Safety glass
15	Point fixing

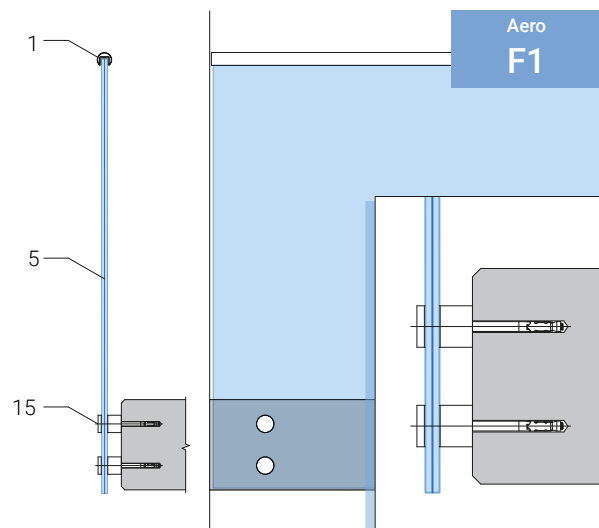

French balconies

1	Handrail profile
2	Glass profile
3	Pillar
5	Glass filling
8	P-profile
12	Glass clamp
14	Clamp profile
15	Point-fixing

FR Nordic

Glass is fixed with 4 stainless steel glass clamps.

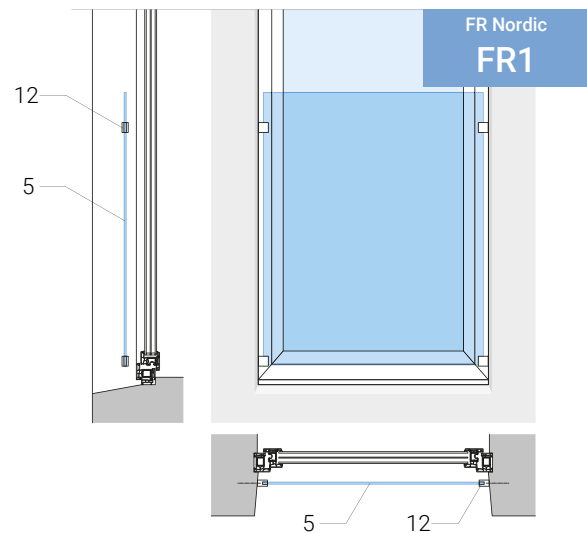

FR Line

Glass is fixed with vertical clamp profile from both sides.

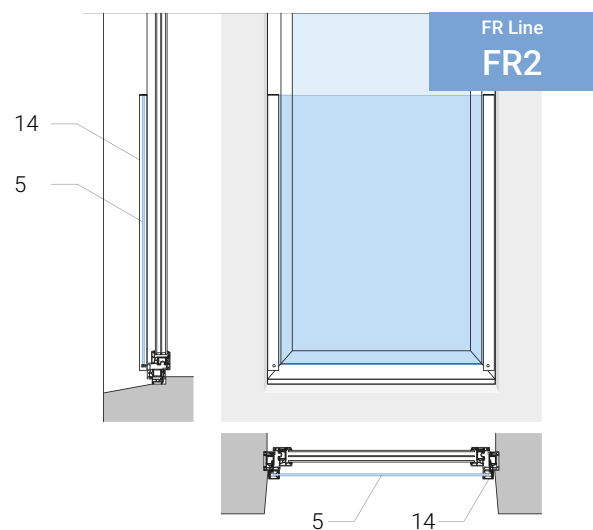

FR Aero

Glass is fixed with 4 stainless steel point fixings.

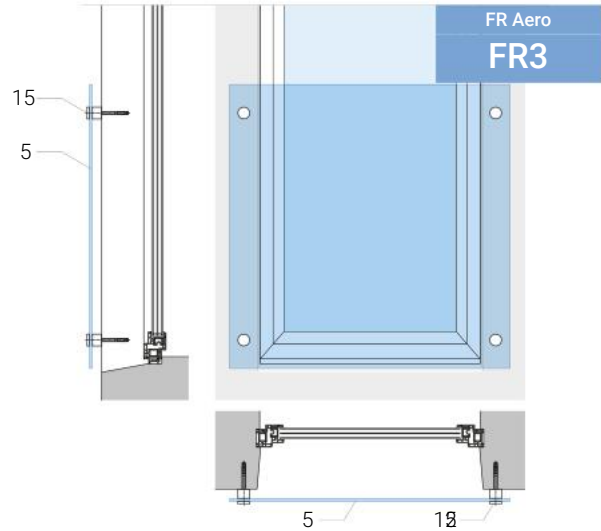

FR Standard

Glass is fixed from top and bottom with glass profile. This type comes with a handrail. The railing is attached to the wall through pillars behind the glass.

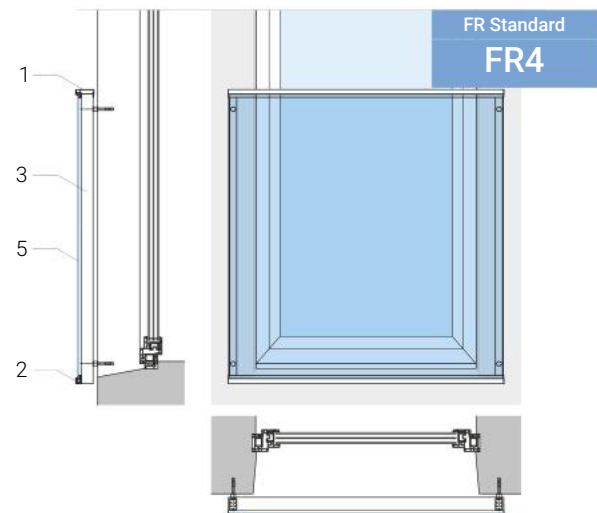

FR Classic

Rods are fixed to a profile from top and bottom. The railing is fixed to the wall with the L-profiles attached to the pillars on both sides.

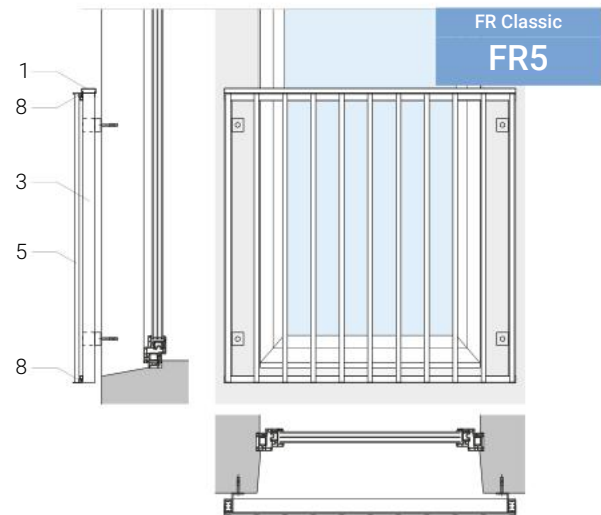

System components

TI20-0001

Gasket (pre-glazing)

TI20-0002

Gasket
(after glazing
6 mm glass)

TI20-0003

Gasket
(after glazing
44.1 glass)

TI20-0004

Gasket
(after glazing
44.2 glass)

SK20-0001

KP1-50 plastic end
gap

SK20-0002

KP1-70 plastic end
gap

SK20-0003

KP2-50 plastic end
gap

SK20-0004

KP2-70 plastic end
gap

SK20-0005

Glass profile
plastic end gap

SK20-0006

Pillar KLM 50
plastic end gap

SK20-0007

Pillar KLM 70
plastic end gap

SK20-0008

P-profile plastic end
gap right side

SK20-0009

P-profile plastic end
gap left side

SK40-0024

End gap for rods

SK20-0034

Glass supporter







MALMERK KLAASIUM

Malmerk Klaasium OÜ

klaasium@malmerk.ee

+372 6599 240

malmerkklaasium.ee

facebook.com/malmerkklaasium

linkedin.com/company/malmerk-klaasium

Valdeku 132, 11216 Tallinn, Estonia



European Union
European Regional
Development Fund



Investing
in your future



EAS
Enterprise Estonia

