



Conference Facilities







Conference Facilities

Contents

Welcome	1
Conference Rooms	2
Pinot Room	3
Merlot+Cuvee Room	4
Pinot+Merlot+Cuvee Room	5
Conference Room Amenities	6
Delegates Packages	7
Conference Catering Menu	9
Conference Request Form	11
Accommodation	12

This document reflects prices as of December 2025. These prices are accurate at the time of writing but may be subject to change in the future.



Welcome

Welcome to Carnmore Chateau Marlborough, the perfect place for your next meeting!

Successful workshops, board meetings, seminars, presentations, interviews, or network events need quality spaces that work.

As a meeting planner you know that choosing a venue that works for everyone is not easy.

Carnmore Chateau Marlborough can tick off your needs – convenient, modern, and intimate in the heart of Blenheim with the bonus of 5-star accommodation and flexible catering options.

Carnmore Chateau Marlborough is a unique venue offering luxury accommodation, catering, and facilities in the latest executive style.

Conference Rooms - Hire Rates

Carmore Chateau Marlborough presents the latest in executive-style boardrooms, hosting up to 35 guests. Our conference venue includes three separate rooms which can also be combined to form one large conference space with adjoining catering facilities.

Pinot 28m ²	Merlot+Cuvee 23m ² + 26m ²	Pinot+Merlot+Cuvee 28m ² + 23m ² + 26m ²
1/2 Day Hire \$95	1/2 Day Hire \$190	1/2 Day Hire \$240
Full Day Hire \$175	Full Day Hire \$320	Full Day Hire \$395

Room Configuration Options



Cocktail

Bar/Barrell Room: 30 max*

* Please contact us directly if you have a larger number in mind

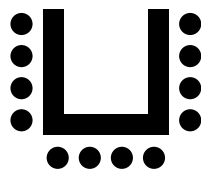

U-Shape

Pinot: 6 max

Merlot+Cuvee: 25 max

Pinot+Merlot+Cuvee: 35 max

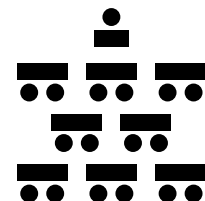

Classroom

Pinot: 8 max

Merlot+Cuvee: 20 max

Pinot+Merlot+Cuvee: 26 max

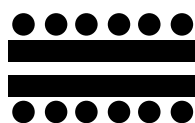

Boardroom

Pinot: 10 max

Merlot+Cuvee: 25 max

Pinot+Merlot+Cuvee: 30 max

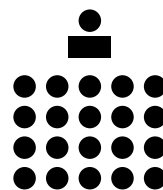

Theatre Style

Pinot: 15 max

Merlot+Cuvee: 25 max

Pinot+Merlot+Cuvee: 35 max

Pinot Room

½ Day Hire
\$95

Full Day Hire
\$175



The Pinot Room is the smallest of our three conference areas. Measuring 28sq metres or 247.5sq feet, this room is able to hold a maximum of 15 people in various seating arrangements.

Interview or quick meeting on Saturday or Sunday?

Grab the Pinot Room for \$55 for up to 2 hours!

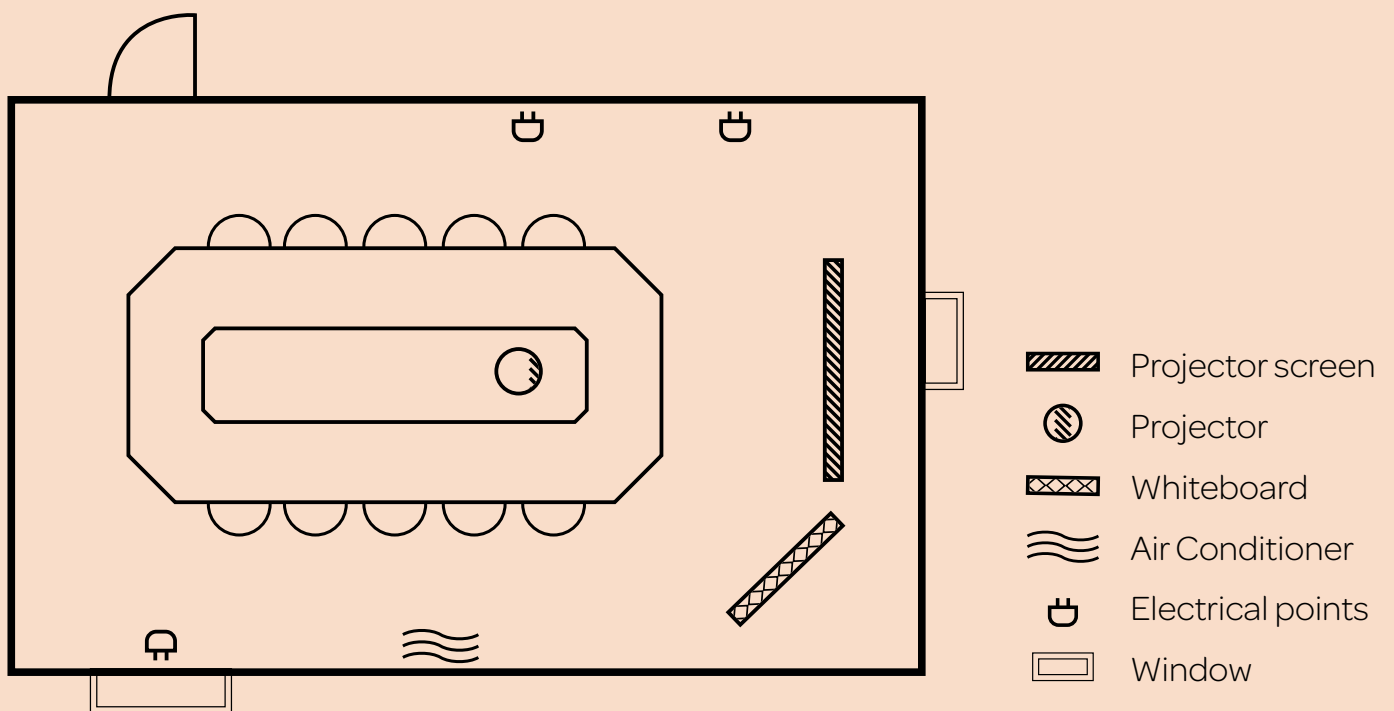

Other seating configurations available, see page 2.

Merlot+Cuvee Room





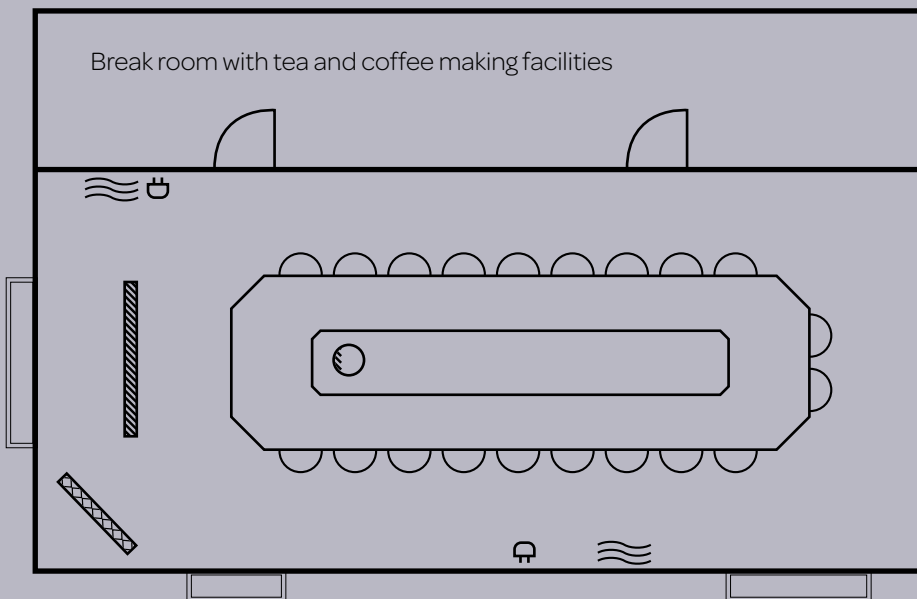

½ Day Hire
\$190

Full Day Hire
\$320



With 2 of our three conference areas joined as one room, the Merlot + Cuvee room is the second largest of our three conference areas. Measuring 49sq metres, this room is able to hold a maximum of 25 people in various seating arrangements. A break room is conveniently adjoined with tea and coffee making facilities.



-  Projector screen
-  Projector
-  Whiteboard
-  Air Conditioner
-  Electrical points
-  Window

Other seating configurations available, see page 2.







Pinot+Merlot+Cuvee Room

½ Day Hire
\$240

Full Day Hire
\$395



With all three conference areas joined as one room, the Pinot + Merlot + Cuvee room is the largest of our conference areas. Measuring 77sq metres, this room is able to hold a maximum of 35 people in various seating arrangements. A break room is conveniently adjoined with tea and coffee making facilities.

-  Projector screen
-  Projector
-  Whiteboard
-  Air Conditioner
-  Electrical points
-  Window

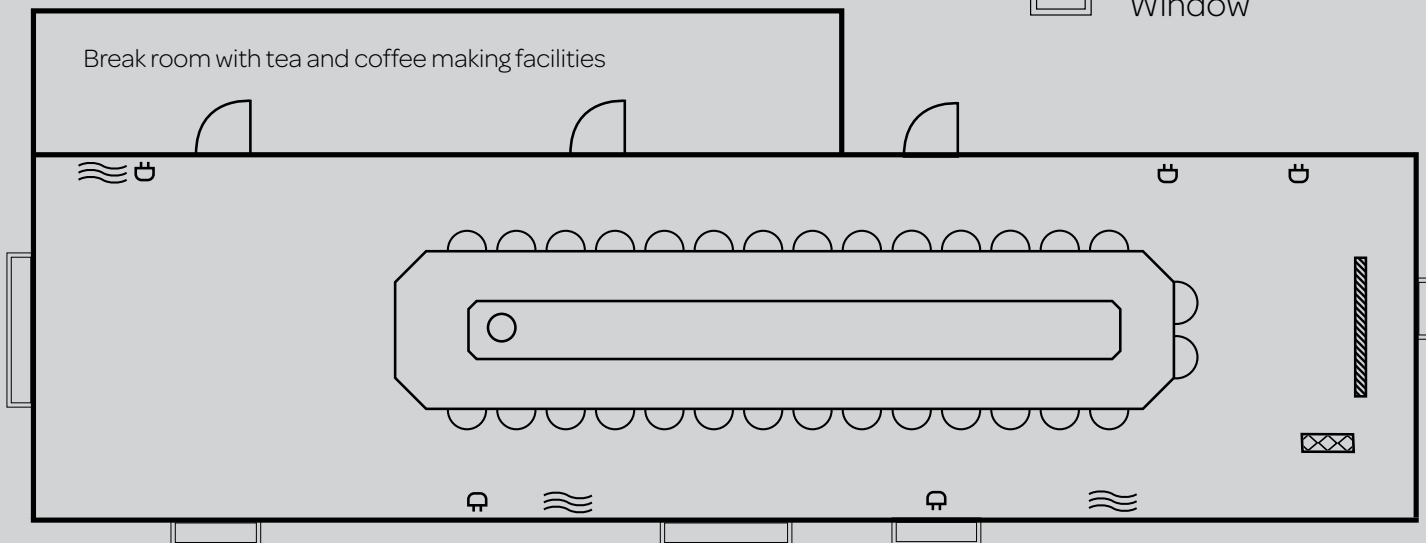

Other seating configurations available, see page 2.



Conference Room Amenities

All conference rooms are all fully equipped with audio/visual presentation equipment including data projectors, and wireless broadband internet is available. Your conference or meeting group will enjoy an environment of luxury, seclusion and comfort with attentive yet unobtrusive service.

- Free Wi-Fi
- Data projector and screen
- Note pads and pens
- TV with HDMI connection
- Android TV and casting facilities
- Mints & ice water
- Tissues
- Whiteboard and markers
- Fully air conditioned / heated
- Comfortable seating
- Electrical power points
- Free parking on-site
- Catering available



Additional equipment is available. Simply let us know your requirements and we will prepare a quotation for you.

Cocktail & Canape Package

\$29pp

This package is only available for groups of 10 or more.

Package includes:

- 1-hour post conference in our bar
- 1 x cocktail/mocktail and selection of canapes

Daily Delegates Package

\$59pp

Includes conference room hire.

This package is only available for groups of 12 or more.

Package includes:

- Data projector with HDMI connection
- Free Wi-Fi
- Whiteboard and pens
- Mints and ice water
- TV with HDMI connection
- Free parking on site
- Morning tea – sweet or savoury snack
- Working lunch – Chef's choice
- Afternoon tea – sweet or savoury
- All day tea and coffee

Daily Delegates Package + Hot food buffet upgrade

\$69pp

Includes conference room hire.

This package is only available for groups of 12 or more.

Package includes:

- Data projector with HDMI connection
- Free Wi-Fi
- Whiteboard and pens,
- Mints and ice water
- TV with HDMI connection
- Free parking on site
- Morning tea – sweet or savoury snack
- Hot food buffet lunch break at our on-site restaurant, Quench
- Afternoon tea – sweet or savoury
- All day tea and coffee

Lunch includes your choice of:

- Spanish Style Meatballs | Ratatouille Sauce | Grilled Mozzarella
- Sticky BBQ Chicken | Asian Style Slaw | Sriracha Dressing
- Spinach, Feta, Herb & Potato Frittata | Tomato and Chipotle
- Marlborough Fish Pie with Leeks & White Wine | Garlic and Herb Crumb
- Slow Cooked Lamb Tagine with Moroccan Spices | Currant and Almond Cous Cous

All served with a green leaf salad | White Balsamic Vinaigrette



Conference Catering Menu

Morning and afternoon tea options

Beverages

Tea or Coffee	\$5.50 pp
Tea or Coffee + 1 x selection	\$12 pp
Tea or Coffee + 2 x selections	\$16 pp
Carafe of Juice	\$20 each
<i>Choice of: Orange Apple Cranberry Pineapple Tomato</i>	

Barista Coffees

A café Selection of Barista Coffees are available from Quench Restaurant. Pre-orders are very welcome so we can have them ready on time to kick start your day!

Savoury Selection

- Triple Cheese Scones *V*
- Corn, Sundried Tomato, Cheese, Herb & Ham Muffins *V available*
- Mini Egg, Bacon, & Caramelised Onion Tartlets *V available*
- Southland Cheese Rolls *V*
- Flaky Pastry Sausage Rolls

Sweet Selection

- Date or Sultana Scones
- Rhubarb and White Chocolate Muffins
- Banana Muffins
- Dark Chocolate Brownie *GF*
- Ginger Crunch
- Salted Caramel Slice *GF available*
- Bliss Balls *GF, DF, V, Vegan*

Lunch Options

Working Lunch | Served in the Conference Room | \$29pp

- Artisan Sandwiches – Club | Ribbon | Pinwheels all with Seasonal Local Ingredients with Mini Savoury Tartlets | Flaky Pastry Sausage Roll Selection

Chef's Sweet Treat served with Tea and Filter Coffee

Family Style menu A | Bowls and Plates to Share | \$39pp

This package is only available for groups of 12 or more.

Select 2 of the options below:

- Sticky BBQ Chicken |Asian Style Slaw |Sriracha Dressing *GF, DF, V and Vegan available*
- Spinach, Feta, Herb & Potato Frittata |Tomato and Chipotle *GF, V, DF available*
- Marlborough Fish Pie | Leeks & White Wine |Garlic and Herb Crumb
- Spanish Style Meatballs |Ratatouille Sauce | Grilled Mozzarella *GF and DF available*
- Slow Cooked Lamb Tagine with Moroccan Spices | Currant and Almond Couscous

Served with Green Leaf Salad |White Balsamic Vinaigrette *DF, GF, V, Vegan*

Chef's Sweet Treat served with Tea and Filter Coffee

Family Style menu B | Bowls and Plates to Share | \$45pp

This package is only available for groups of 12 or more.

Select 2 of the options below:

- Carved Rare Beef |Balsamic Beetroot |Bearnaise |Shallots *GF, DF*
- Roast Vegetable Salad |Smoked Onions |Harissa Dressing *GF, DF, V, Vegan*
- Spiced Yoghurt Chicken Thighs |Cardamom-Coconut Rice Pilaf *GF*
- Gnocchi with Osso Bucco Ragu and Orange Gremolata

Served with Green Leaf Salad |White Balsamic Vinaigrette *GF, DF, V, Vegan*

Chefs sweet Treat served with Tea and Filter Coffee

Menu Extras

Marlborough Artisan Cheeses Condiments Crackers	\$15 pp
Seasonal Fresh Fruit Bowl	\$5 pp
Individual Vanilla Ice Cream Tubs	\$6 each
'Proper' Salted Crisps 40-gram packets	\$3.50 each
Cashew Nuts – lightly salted	\$4.50 each
Whittaker's Sante Milk Chocolate Bar	\$3.50 each

Please Note:

Lunch is served in the Barrel Room next to Quench Restaurant and Bar on the ground Floor.

Weather permitting lunch can be served al fresco poolside.

We do cater for Gluten Free |Dairy Free |Vegetarian however we are unable to cater for any further dietary requirements. All catering requirements are required 5 business days prior to arrival.

Packed Lunches are also available for those needing to be off-site during lunchtime.

Breakfast is also available for those wanting to have breakfast meetings or those wanting to start the day earlier.

Conference Request

Apply Online

Welcome to our convenient online Conference Request Form!

This streamlined platform has been designed to make the process of submitting conference requests as smooth as possible. Whether you're seeking approval for attendance, funding, or participation, this form will guide you through the essential information we need to know. Your time is valuable, so we've made sure that the form is intuitive and easy to navigate. Let us help you bring your conference aspirations to reality – begin your journey by following the link below, or scanning the QR code.

<https://qrco.de/beMTH7>



SCAN ME

* Booking confirmation will be received via email.

Contact Us

New Zealand Toll Free - 0800 75 22 75

Australian Toll Free Number - 1800 212 773

Reception Telephone - +64 (0)3 578 0064

chateau@chateamarlborough.co.nz

Cnr High and Henry Streets, Blenheim, Marlborough

PO Box 921, Blenheim 7201, Marlborough

Accommodation

Relax here, before or after your conference. Here at Carnmore Chateau Marlborough, we have a range of boutique accommodation options to suit your individual preferences which all include a range of quality amenities.

- Complimentary Wi-Fi
- In room safe
- 42" screen TV
- Tea and coffee making facilities
- Individually controlled heating/air conditioning
- Work desk
- Room service
- Mini bar on request

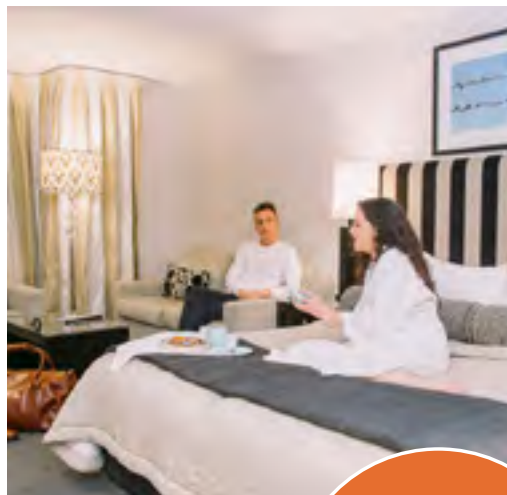

Special offer*

Book your corporate accommodation at carnmore.co.nz and you will receive 10% off the best available rate.

USE CODE: corporateSAVE

Also receive:

- Free early midday check-in
- Free late 11am check-out
- Free scanning and copying service (up to 20 pages)
- Shortened cancellation policy of 24 hours
- No credit card surcharge

*Offer only available when 6 or more rooms are booked together.

SAVE
10%





Phone +64 3 578 0064
Email: chateau@chateaumarlborough.co.nz
Cnr High and Henry Streets, Blenheim
Marlborough, New Zealand



Freephone: 0800 840 848 Phone +64 3 595 6569
Email: info@carmorehotelchristchurch.co.nz
840-848 Colombo Street
Christchurch Central, New Zealand



Freephone: 0800 33 11 99 Phone +64 3 348 0909
Email: info@carmorehagleypark.co.nz
22 Riccarton Road, Riccarton
Christchurch, New Zealand



Phone +64 9 486 1069
Email: info@carmorehoteltakapuna.co.nz
2 Rewiti Avenue, Takapuna
Auckland, New Zealand