

RUGGED

User Manual

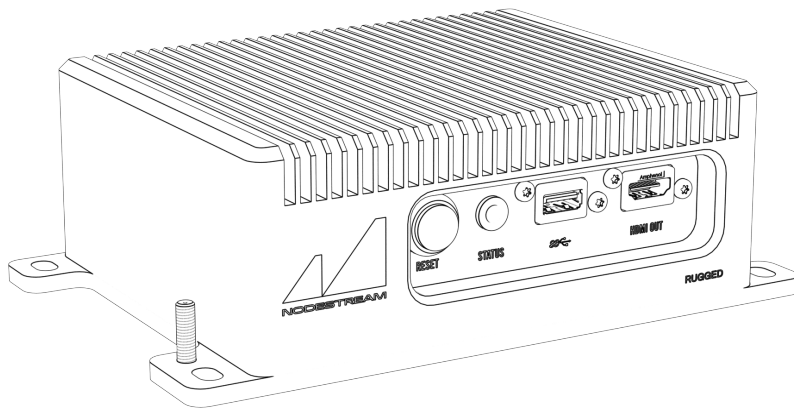

Please read these instructions carefully before using this product



Information for your safety

The device should only be serviced and maintained by qualified service personnel. Improper repair work can be dangerous. Do not attempt to service this product yourself. Tampering with this device may result in injury, fire, or electric shock, and will void your warranty.

Be sure to use the specified power source for the device. Connection to an improper power source may cause fire or electric shock.



Operation Safety

Before using the product, ensure all cables are not damaged and connected correctly. If you notice any damage, contact the support team immediately.

- To avoid short circuits, keep metal or static objects away from the device.
- Avoid dust, humidity, and temperature extremes. Do not place the product in any area where it may become wet.
- Operating environment temperature and humidity:
Temperature: Operating: -20°C to 65°C Storage: -20°C to 80°C
Humidity (non-condensing): Operating: 0% to 90% Storage: 0% to 95%
- Unplug the device from the power outlet before cleaning. Do not use liquid or aerosol cleaners.
- Contact the support team support@harvest-tech.com.au if you encounter technical problems with the product.

Symbols



Warning or caution to prevent injury or death, or damage to property.



Extra notes on the topic or steps of the instructions being outlined.



Further information to content outside the scope of the user guide.



Extra pointers or suggestions in executing instructions.



Contact and Support
support@harvest-tech.com.au



User Resources

Harvest Technology Pty Ltd
7 Turner Avenue, Technology Park
Bentley WA 6102, Australia
harvest.technology

Disclaimer and Copyright

Whilst Harvest Technology will endeavor to keep the information in this user guide up to date, Harvest Technology makes no representations or warranties of any kind, express or implied about the completeness, accuracy, reliability, suitability or availability with respect to the user guide or the information, products, services or related graphics contained in the user guide, website or any other media for any purpose.

The information contained in this document is believed to be accurate at the time of release, however, Harvest Technology cannot assume responsibility for any consequences resulting from the use thereof.

Harvest Technology reserves the right to make changes to any of its products and associated documentation at any time without notice. Harvest Technology does not assume any responsibility or liability arising out of the application or use of any of its products or associated documentation.

Any decisions you make after reading the user guide or other material are your responsibility and Harvest Technology cannot be held liable for anything you choose to do.

Any reliance you place on such material is therefore strictly at your own risk.

Harvest Technology products, including all hardware, software and associated documentation is subject to international copyright laws. The purchase of, or use of this product convey a license under any patent rights, copyrights, trademark rights, or any other intellectual property rights from Harvest Technology.

Warranty

The warranty for this product can be found online at:
<https://harvest.technology/terms-and-conditions/>

FCC Compliance Statement



NOTE: This equipment has been tested and found to comply with the limits for a Class A digital device, pursuant to part 15 of the FCC rules. These limits are designed to provide reasonable protection against harmful interference when the equipment is operated in a commercial environment. This equipment generates, uses, and can radiate radio frequency energy and, if not installed and used in accordance with the user manual, may cause harmful interference to radio communications. Operation of this equipment in a residential area is likely to cause harmful interference in which case the user will be required to correct the interference at their own expense.

Changes or modifications not expressly approved by the party responsible for compliance could void the user's authority to operate the equipment.

In order to maintain compliance with compliance regulations, shielded HDMI cables must be used with this equipment

CE/UKCA Compliance Statement



Marking by the (CE) and (UKCA) symbol indicates compliance of this device with the applicable directives of the European Community and meets or exceeds the following technical standards.

- Directive 2014/30/EU - Electromagnetic Compatibility
- Directive 2011/65/EU - RoHS, restriction of the use of certain hazardous substances in electrical and electronic equipment

Warning: Operation of this equipment is not intended for a residential environment and could cause radio interference.

CONTENTS

Getting Started	1
Introduction	1
Key Features.....	1
Typical Setup.....	1
Connections	2
Configuration	3
Overview	3
Access	3
Local Access	3
Web Access.....	4
Initial Configuration.....	5
Network	5
Information.....	6
Testing.....	6
Port Configuration.....	7
Firewall Settings	8
Discovery	8
System	9
Applications.....	9
Reset and Support	9
Update Password.....	9
System Mode.....	10
Server Configuration.....	10
Updates.....	11
Nodestream X Operation	12
Overview	12
Overlay	12
Video.....	13
Encoding	13
Decoding.....	15
Audio.....	16
Data.....	16
Control Applications	17
Nodestream Live Operation	17
Overview	17
Encoder Inputs	17
Hardware	17
Network.....	17
Audio.....	17
Appendix	18
Technical Specifications.....	18
Troubleshooting	19
System.....	19
Network.....	19
Video.....	20
Audio.....	20



Getting Started

Introduction

The Nodestream Rugged enables streaming in the harshest conditions where moisture, dust, heat and vibration are of concern.

Key Features

General

- Rugged fanless, IP rated enclosure
- Extended operating temperature
- Industrial connectivity
- Wide input voltage range, low power consumption
- Low bandwidth, low latency HD streaming of up to 16 video channels from 8Kbps to 5Mbps
- Multiple input types - HDMI, USB and IP streams

Nodestream X

- Encoder or Decoder operation
- Up to 16 x simultaneous video streams
- Nodecom audio channel
- Up to 20 x data streams
- Forward decoded video streams to Nodestream Live

Nodestream Live

- Up to 16 x simultaneous video streams

Typical Setup

Nodestream X

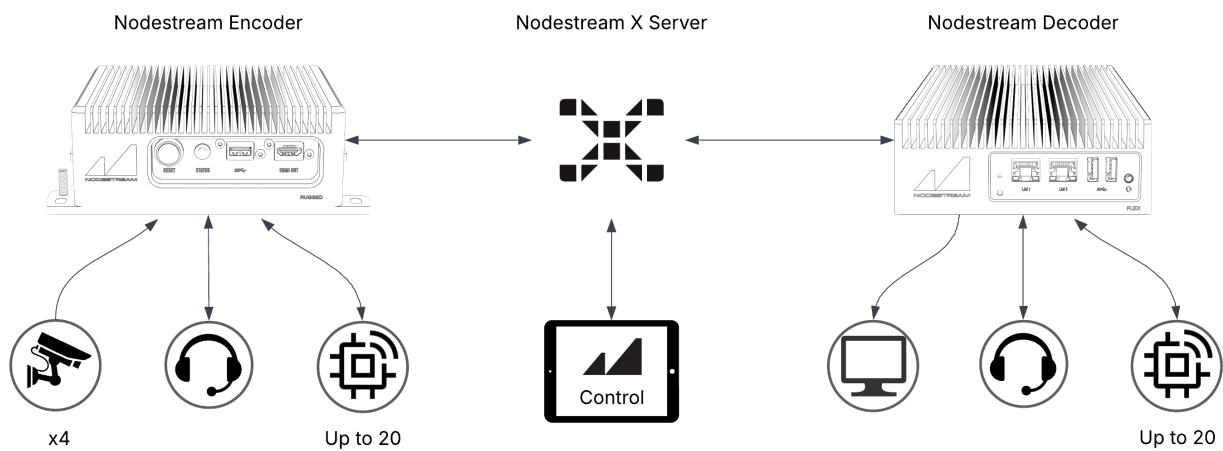

Nodestream Live

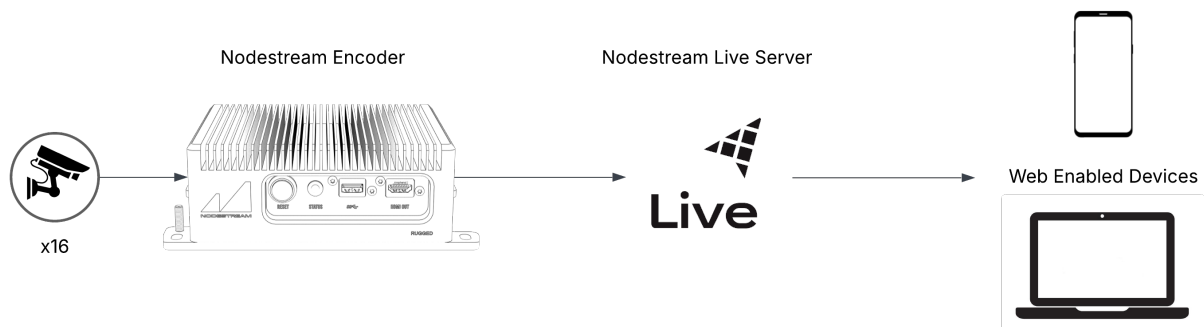



Connections

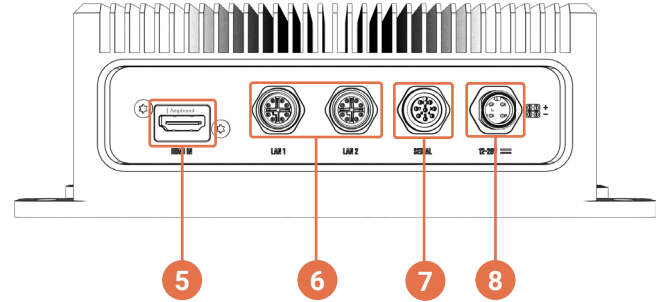
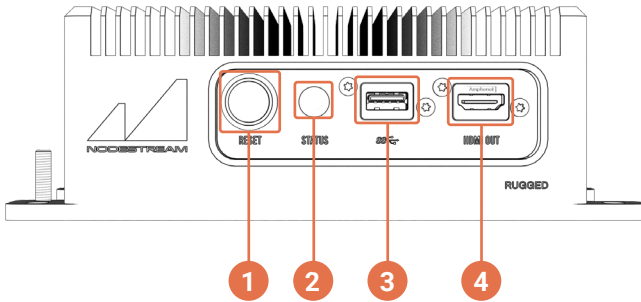

- 1 Reset button**
Reset - Press 2 sec & release
Factory Reset - Press & hold
- 2 Status LED**
RGB LED to indicate system status
BLUE System star
GREEN Solid (streaming), Flash (idle)
RED Network/server issue
- 3 USB A 3.0**
Connection of peripherals
- 4 HDMI Output**
Display output
- 5 HDMI Input**
Connection to a HDMI video source
- 6 Gigabit Ethernet**
2 x M12 8pin X coded
- 7 RS232 Serial**
M12 8pin A coded - /dev/ttyTHS0
- 8 Power Input**
M12 4pin A coded - 12-28VDC

Power	
Pin	Description
1	+ (12 to28V)
2	+ (12 to28V)
3	GND
4	GND

LAN1/2			
PIN	Description	Pin	Description
1	BI_DA+	5	BI_DD+
2	BI_DA-	6	BI_DD-
3	BI_DB+	7	BI_DC+
4	BI_DB-	8	BI_DC-

Serial			
PIN	Description	Pin	Description
1	RS232 RXD	5	GND
2	RS232 TXD	6	CAN High
3	RS232 RTS	7	CAN Low
4	RS232 CTS	8	GND

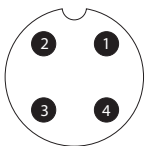

M12 A Coded Male

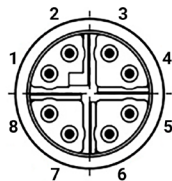

M12 X Coded Female

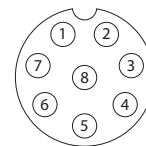

M12 A Coded Female



- Nodestream devices are supplied with a Quick Start Guide for installation and detailed UI function. Scan the User Resources QR code on the last page for access
- Device will boot automatically when power is applied



Configuration

Overview

The Web Interface provides details and management of;

- Software version information
- Network(s)
- User login credentials
- Remote support
- System mode
- Server settings
- Updates

Access

The Web Interface can be accessed locally on your device, or a web browser of a PC connected to the same network.

 Web Interface is not available until the Nodestream software has started

Local Access

1. Connect your device to your LAN, monitor, keyboard/mouse and power it up.

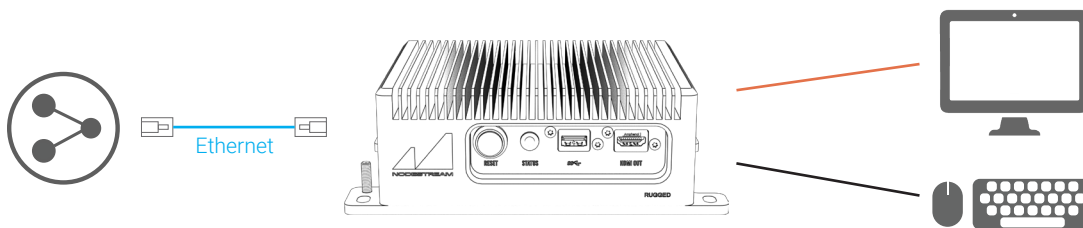

2. Wait for the software to start and press alt+F1 on your keyboard or right click and select configuration.
3. When prompted, enter your login details.

Default username = admin
Default password = admin

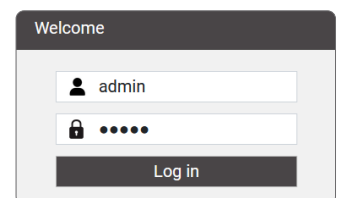



Web Access

Connect a computer to the same network as your device or directly to the device via an Ethernet cable.

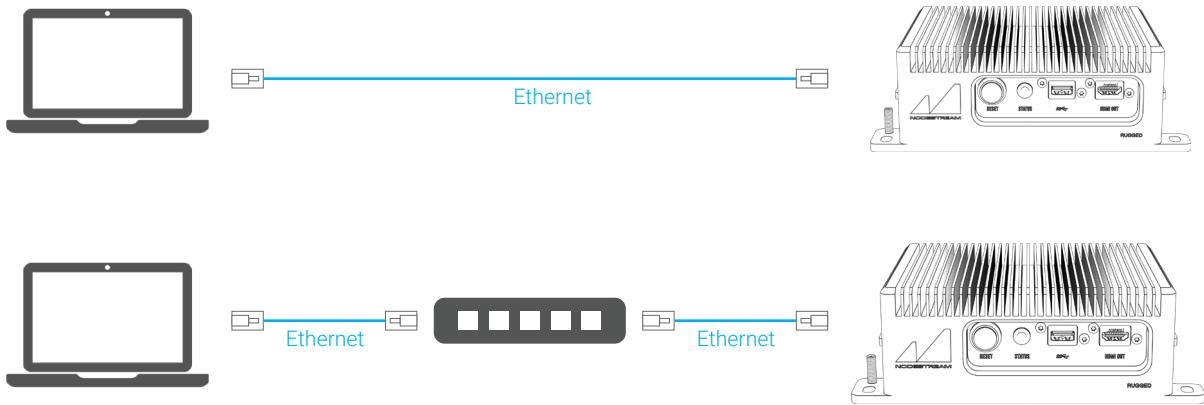

DHCP Enabled Network

1. Connect your device to your LAN and power it up.
2. From the web browser of a computer connected to the same network, enter the device IP address or `http://serialnumber.local` , e.g `http://au2518nsrx2a014.local`
3. When prompted, enter your login details.



Serial number can be found on the product label, affixed to the side of your device

Non-DHCP Enabled Network

If your device is connected to a non-DHCP enabled network, and its network has not been configured, it will fall-back to a default IP address of 192.168.100.101.

1. Connect your device to your LAN and power it up.
2. Configure the IP settings of a computer connected to the same network to:

IP	192.168.100.102
Subnet	255.255.255.252
Gateway	192.168.100.100
3. From a web browser, enter 192.168.100.101 in the address bar.
4. When prompted, enter your login details.



When configuring multiple devices on a non-DHCP enabled network, due to IP conflicts, only 1 device can be configured at a time. Once a device has been configured, it may be left connected to your network



Initial Configuration

Nodestream devices require the following to be configured prior to operation;

- Network(s)** refer below
- System Mode** refer "[System Mode](#)" on page 10
- Server(s)** refer "[Server Configuration](#)" on page 10



The primary network of your Nodestream device must be configured to ensure a stable connection and prevent the device from setting its IP address to its static default.

1. Login to the Web Interface.
2. Once logged in, you will notice an orange prompt to configure the MAIN interface.

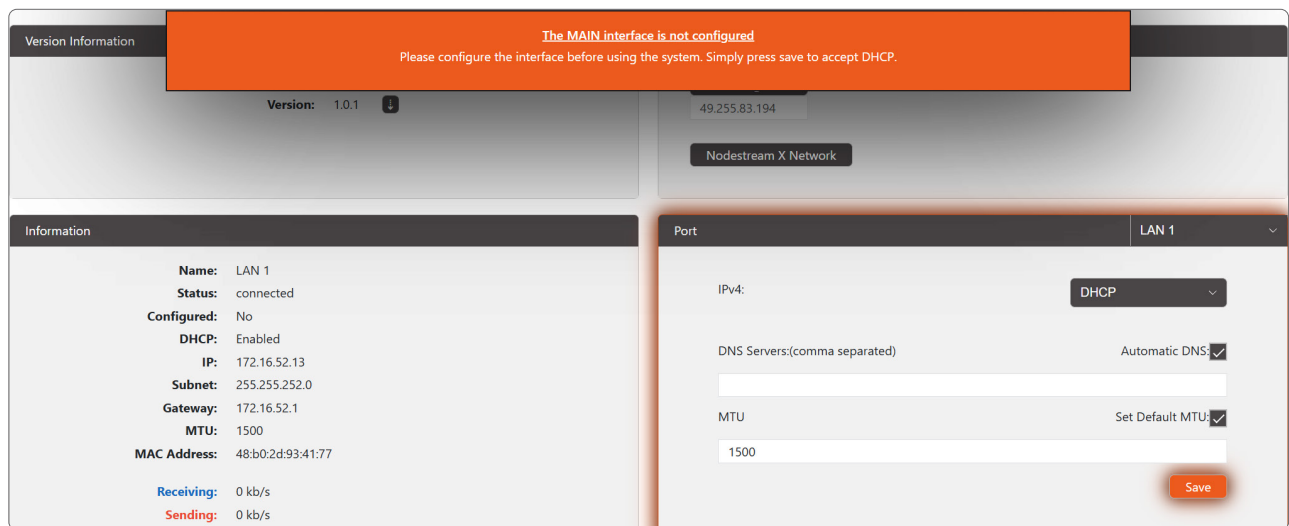

3. If connected to a DHCP enabled network click save in the "Port" window. Refer to "[Port Configuration](#)" on page 7 for configuration of static IP settings.

Network

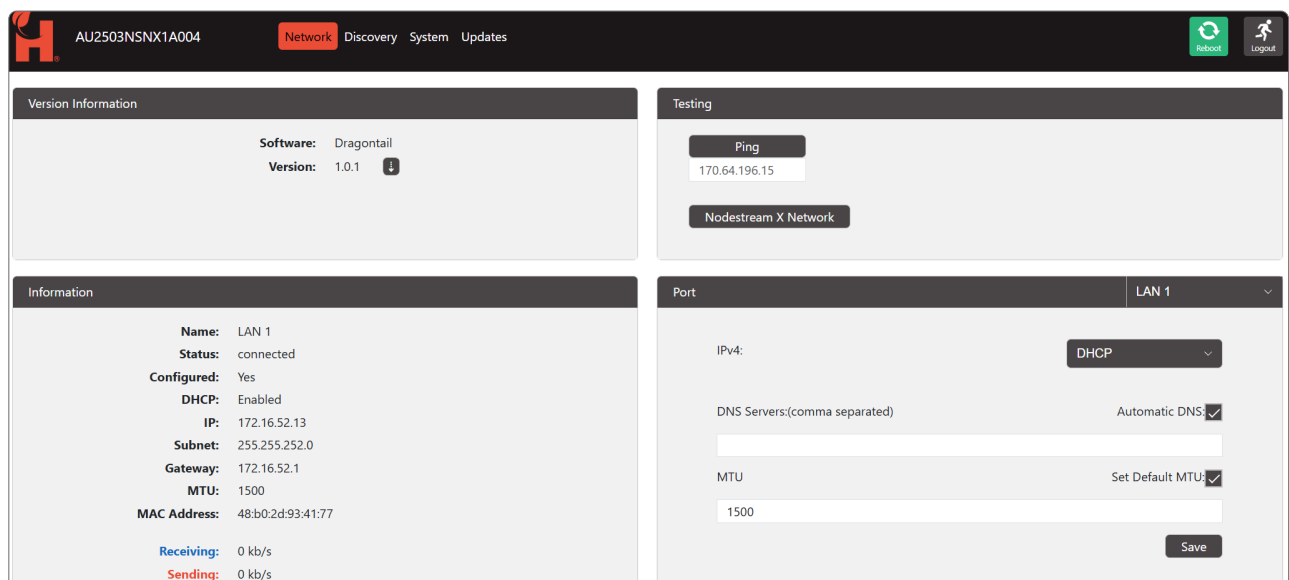



Information

Displays information related to the selected port (select from the drop down in the "Port" section)

Name	Name of the port
Status	Connection status of the port
Configured	Shows if the port been configured
DHCP	DHCP has been enabled or disabled
IP	IP address
Subnet	Subnet
Gateway	Gateway
MTU	Max transmission unit setting
MAC Address	Adapter MAC address
Receiving	Live "receiving" throughput
Sending	Live "sending" throughput

The screenshot shows a panel titled "Information" with the following data:

Name:	LAN 1
Status:	connected
Configured:	Yes
DHCP:	Enabled
IP:	172.16.52.13
Subnet:	255.255.252.0
Gateway:	172.16.52.1
MTU:	1500
MAC Address:	48:b0:2d:93:41:77
Receiving:	0 kb/s
Sending:	0 kb/s

Testing

Ping

For testing connection to your Nodestream X server or other devices on your network, i.e. IP cameras.

1. Enter IP address to ping
2. Click Ping button
3. Notification will display followed by either
 - Ping time in ms successful
 - Could not reach the IP address unsuccessful

The screenshot shows a panel titled "Testing" with a "Ping" button. Below the button is a text box containing the IP address "49.255.83.194". At the bottom of the panel is a button labeled "Nodestream X Network".

Nodestream X Network

This tool provides a means to test if all network requirements are in place to allow your device to function correctly when operating in Nodestream X modes. The following tests are performed to your Nodestream Server;

1. Ping test to the server
2. TCP port test
3. TCP STUN test
4. UDP port test



- Nodestream X Server configuration required, refer "[Server Configuration](#)" on page 10
- Nodestream devices require Firewall rules to be in place, refer "[Firewall Settings](#)" on page 8



Port Configuration

Ethernet

Select the port you'd like to configure from the "Port" drop down.

DHCP

1. Select "DHCP" from the "IPv4" drop down if not already selected, then save.
2. When prompted, confirm IP settings change.

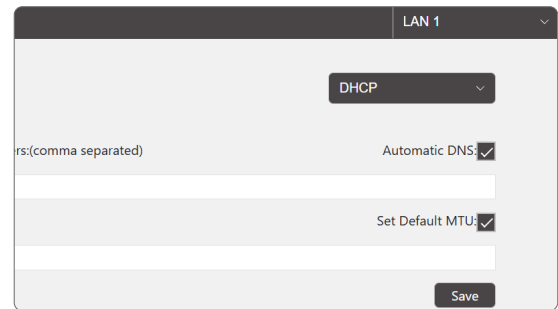

Manual

1. Select "Manual" from the "IPv4" drop down.
2. Enter network details as provided by your Network Administrator, then click save.
3. When prompted, confirm IP settings change.
4. To log back into the Web Interface, enter the new IP address or `http://serialnumber.local` in your web browser.

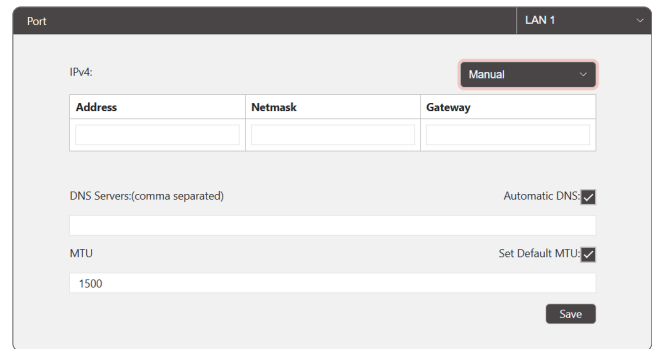

WiFi

WiFi is only available if an optional USB WiFi adapter is installed. Verified compatible WiFi adapters:

- TP-Link T2U v3
- TP-Link T3U
- TP-Link T4U

1. Select "WiFi" from the "Port" drop down.
2. Select network from list of available networks from the "Visible Networks" drop down.
3. Select security type and enter password.
4. Click save for DHCP or select "Manual", enter port details as provided by your Network Administrator then click save.

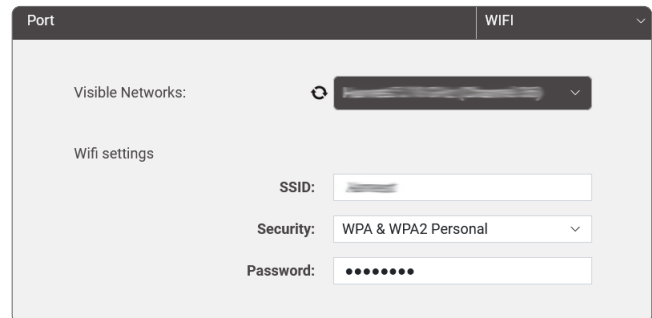

Disconnect

1. Select WiFi from the "port" drop down.
2. Click the "Disconnect" button.





- Only IPv4 networks are supported
- LAN 1 MUST be used for Nodestream traffic. LAN 2 is used for connecting to separate network stream inputs



Were a non-default MTU is set for a port, you MUST re-enter the value when changing port settings for the value to be retained.



Firewall Settings

It is common for corporate network firewalls/gateways/anti-virus software to have strict rules in place that may require modification to allow Nodestream devices to function.



Nodestream X devices communicate with the server and each other via TCP/UDP ports, therefore the following permanent network rules for all inbound & outbound traffic must be in place:

Ports

TCP 8180, 8230, 45000, 55443 & 55555

UDP 13810, 40000 & 45000 - 45200

Server access to IP address



Allow traffic to/from (whitelist);

- myharvest.id
- *.nodestream.live
- *.nodestream.com.au
- *.ns.live



- All port ranges are inclusive
- Contact Harvest support for further information. support@harvest-tech.com.au

Discovery



Access Nodestream Devices

Nodestream devices connected to the same network as your device will display. Click the → icon next to the Device IP to open its Web Interface in a new window.

Copy Nodestream X Server Details

To copy the Nodestream X server details from another device;

1. Click the ⬆ icon of the device server details you'd like to copy
2. Confirm the action
3. Nodestream X software will restart and connect to the new server

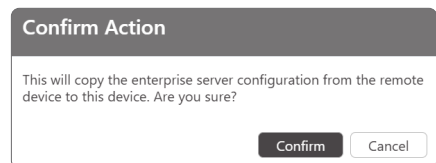

Access Nodestream X Server

To access the Nodestream X server web interface, click the → icon next to the Nodestream X Server IP.



System

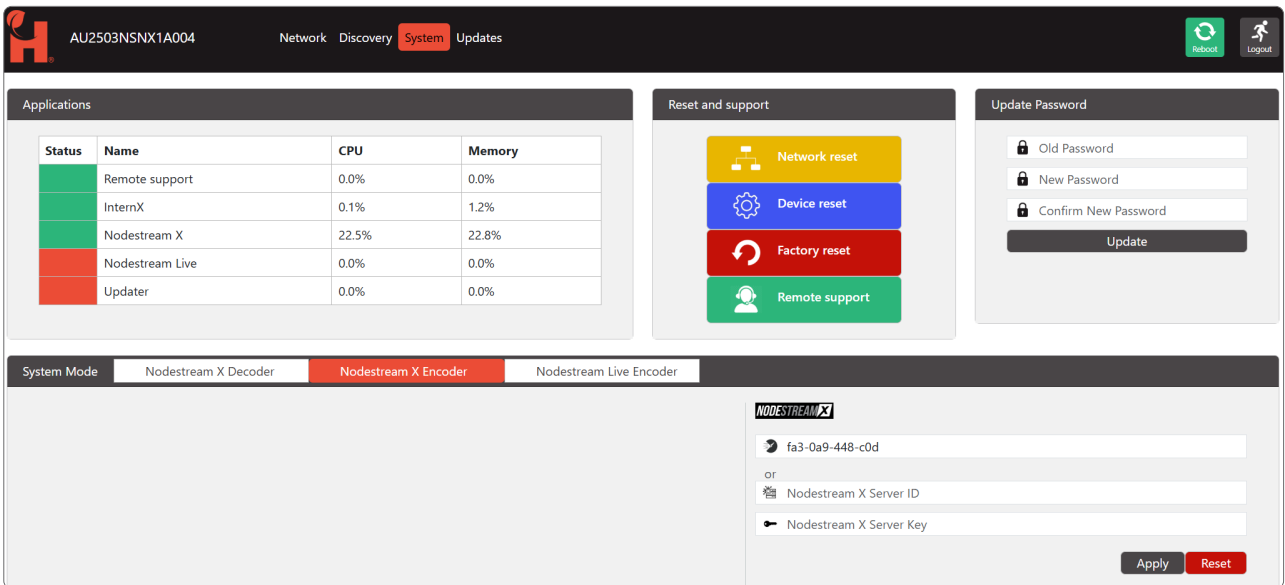

Applications

Displays information relating to software processes and their resource usage. This can be useful in diagnosing software and/or performance issues.

Reset and Support

- Network Reset** Resets all network settings to default.
- Device Reset** Resets all application and server settings to default
- Factory Reset** Resets ALL device settings to default (alternatively, hold "ctrl+alt" and press "r" on a connected keyboard, or use the reset button, see below, to factory reset your device)

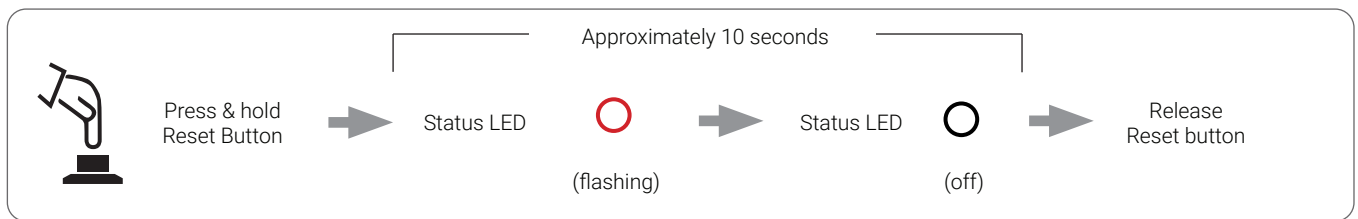

Remote Support Remote support enables Harvest support technicians to access your device if advanced troubleshooting is required. To enable/disable, click the "remote support" button.

 Remote support is enabled by default

Update Password

Allows you to change the Web Interface login password. If the password is unknown, perform a factory reset. Refer "Reset and Support" above.



System Mode

Your Nodestream device can operate as either;

Nodestream X Encoder

Nodestream X Decoder

Nodestream Live Encoder

Active mode is highlighted in RED. To change mode click the applicable button.

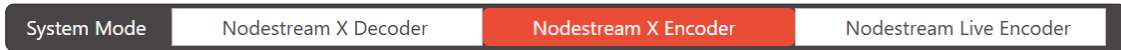

Server Configuration

All Nodestream devices require configuration to a server for connection and settings management.



Enter the "quick code" or Server ID and Key provided by your Nodestream Administrator, then click "Apply".

Once a device has been registered to a server, your Nodestream Administrator will need to add the device to a group within the server before it can be used.



When operating in Nodestream X Decoder mode, the "decoded" stream can be forwarded on to Nodestream Live. This requires registration of your device to your Live server.



Live

To register your device, login to your Nodestream Live web portal and add a new device. When prompted enter the 6 digit code shown in your device Web Interface system page or device desktop (device must be in Nodestream Live Encoder or Nodestream X Decoder mode).

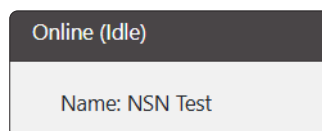
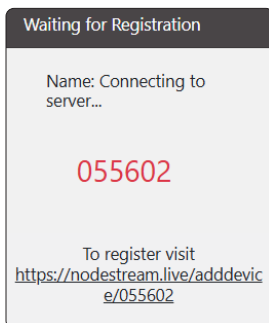

Device registered
not streaming

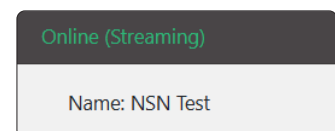

Device registered
streaming



Updates

Automatic Updates

Automatic updates are disabled by default. Enabling this feature allows the device to download and install software when a newer version is available. During this process the device may restart. If this is not desired, set to "No".

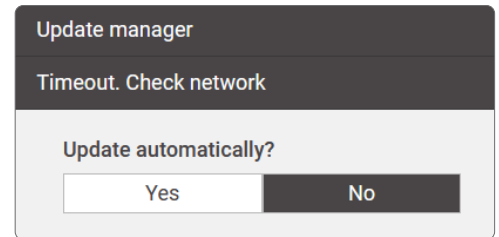

Manual Updates

When an update is available for your device, an icon will be displayed next to the "Updates" tab.

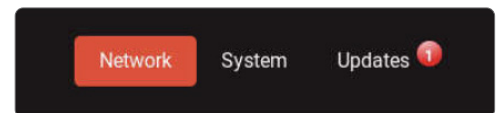

To Install the available update(s):

1. Open the Updates section of the Web Interface.
2. Select "Update (permanent install)" and accept the conditions when prompted.
3. The updated manager will proceed to download and install the update.
4. Once the update process is complete your device or the software may restart.



Updates are installed incrementally. When a manual update has completed, continue to refresh the update manager and install updates until your device is up to date.



Nodestream X Operation

Overview

Nodestream X is a point to point video, audio and data streaming solution with ultimate control allowing customers to meet operational requirements. A basic system comprises of;

Encoder	Ingest and encode video/data/audio
Decoder	Display/output decoded streams
Control Application	Manage connections and settings
Server	Manage device groups, users, licensing and communicate control messages

Overlay

When a monitor is plugged into your device and the system is in standby mode (not streaming video), an overlay displays system information. This allows the user to view current system status and assists with diagnosing system issues.



- 1 Video Mode / Software Version**
Current video mode - Encoder or Decoder and Nodestream software version installed.
- 2 Device Serial**
Serial number of device.
- 3 Server IP**
IP address of your Nodestream server.
- 4 Network Status**
Displays current status of network ports:

IP address shown	Network connected and configured.
down (unplugged)	Network not connected to device.
not configured	Network not configured - refer " Port Configuration " on page 7
- 5 Server Connection Status**

Waiting for Nodestream connections	Connected to server, ready to connect to another device.
Connecting to Nodestream server	Connecting to server.
Server connection error	There is a network issue preventing connection to the server. Refer " Troubleshooting " on page 19
- 6 Frame Rate, Resolution & Bit-rates**
Frame rate and resolution of video that will be streamed to a Decoder (Encoder mode only), and current transmit and receive bit-rates.

If overlay is not displayed, it may be disabled. Enable it via your Harvest Control Application.



Video

Encoding

When your device is operating in Encoder mode, inputs can be viewed on a connected monitor. Inputs, as selected via your Harvest control application, will be displayed. This can be useful to diagnose issues with hardware and/or network stream video inputs.



Displayed video is a direct reflection of what will be sent to a connected Decoder. Changes to frame rate and resolution will be visible.

Hardware Inputs

Compatible sources connected to the device via HDMI or USB 3.0 can be selected as inputs within your Harvest control application. For a detailed list supported input types refer "[Technical Specifications](#)" on page 18.

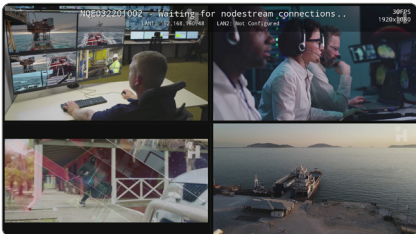

Typical Encoder display, 4 x video sources selected and waiting for Nodestream connections

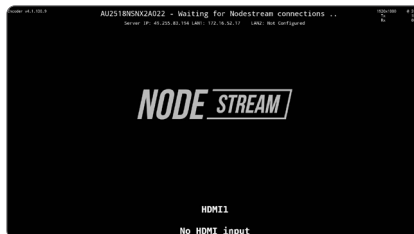

No video source connected to selected input Refer "[Troubleshooting](#)" on page 19

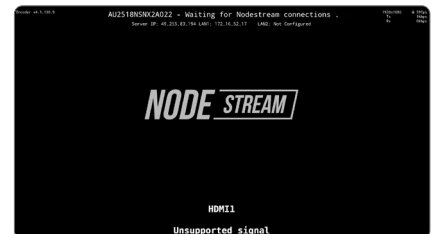

Video source not supported Refer "[Troubleshooting](#)" on page 19



Due to copyright restrictions, HDCP (High-bandwidth Digital Content Protection) signals such as DVD players and media streamers cannot be captured.

Test Sources

Test video sources are built into your device for use as an input to assist with troubleshooting or initial setup. These can be selected via your Harvest control application.

Test Source	Test video loop
Test Pattern	Simple low bandwidth loop
Colour Bars	Colour bars with white noise section for testing colour and high bandwidth

Pro Mode

Enable Pro Mode, via your Harvest Control Application, to activate the following features:

4K60 Video (4 x 1080/60)

Frame Synchronous Data

UDP data input on port 40000 is streamed, frame synchronous, with the accompanying video. This can be output to up to 4 network devices from your connected Nodestream X Decoder.



- Pro Mode can only be activated when hours are available on your account. To purchase hours, contact sales@harvest-tech.com.au.
- When hours have been depleted, all Pro Mode enabled streams will fall back to 1080/60.



Network Sources

Network sources available on the same network as your device, such as those from IP cameras, can be decoded and used as inputs. Inputs are added and managed via the Harvest control application.

RTSP

Real-Time Streaming Protocol is typically used for streaming IP cameras. They are unique to camera manufacturers and can differ between models. The URI of the source must be known before it can be used as an input. If authentication is enabled on the source device, the user name and password must be known and included in the URI address.

URI rtsp://[user]:[password]@[Host IP]:[RTSP Port]/stream
Example URI rtsp://admin:admin@192.168.1.56:554/s0

RTP

Real-Time Transport Protocol (RTP) is a network protocol for delivering audio and video over IP networks. RTP typically runs over User Datagram Protocol (UDP). RTP differs from RTSP in that the RTP source needs to know the IP address of the receiver beforehand, as it pushes the video stream to that designated IP.

URI rtp://[Receiver IP]:[RTP Port]
Example URI rtp://192.168.1.56:5004

UDP

Video data can also be transmitted and received over plain UDP. It acts similarly to RTP where the video source will push data to the receiver, requiring in advance to know the destination before streaming can occur. Generally, it's preferable to use RTP instead of plain UDP if the user has the choice due to inbuilt mechanisms like jitter compensation in RTP.

URI udp://[Receiver IP]:[UDP Port]
Example URI udp://192.168.1.56:5004

HTTP

HTTP streaming comes in several formats; Direct HTTP, HLS, and HTTP DASH. Currently only Direct HTTP is supported by Nodestream but it is not recommended.

URI http://[Host IP]:[Host Port]
Example URI http://192.168.1.56:8080

Multicast

Multicast is a one-to-one or more connection between multiple Decoders and the source. Connected routers must be multicast enabled. The range of IP addresses reserved for multicast is 224.0.0.0 - 239.255.255.255. Multicast streaming can be delivered via RTP or UDP.

URI udp://[Multicast IP]:[Port]
Example URI udp://239.5.5.5:5000

PTZ Control

Your Nodestream device is able to control network PTZ cameras via the Windows Harvest Control Application. Cameras must be ONVIF compliant, enabled, and configured with the exact security credentials as the associated RTSP stream.



- Set source resolution to 1080 and frame rate to 25/30 for best performance.
- Use the ping tool in the Web Interface and/or software such as VLC from a PC connected to the network test/confirm network stream IP's and URL's.
- Direct cameras away from dynamic references where practical, i.e. water, trees. Reducing image pixel changes will decrease bandwidth requirements.



Decoding

When your device is operating in Nodestream X Decoder mode, and connected to an Encoder, up to 4 video streams will be displayed on a connected monitor.

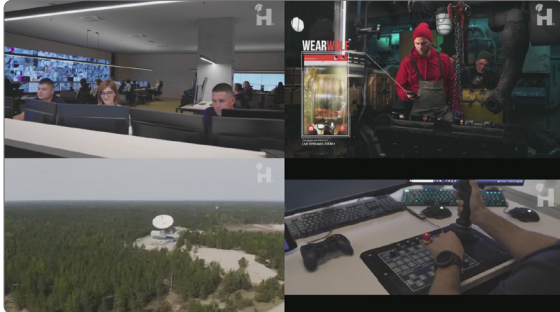

Active stream

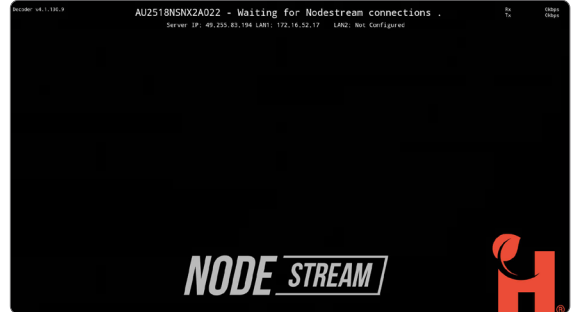

System idle

RTP Outputs

Your device can be configured to output its decoded video streams in RTP format for viewing on another device within the connected network or integration into a 3rd party system, i.e. NVR.

1. **Device Configuration** (via your Harvest control application)
 - Select your device and navigate to its video settings
 - Enter the destination IP and assign a port for the outputs you wish to use, up to 4.
2. **View the Stream** (below are 2 examples, other methods not listed may be suitable)

SDP File

Configure an SDP file using a text editor with the following.

```
c=IN IP4 127.0.0.1
m=video 56000 RTP/AVP 96
a=rtpmap:96 H264/90000
a=fmtp:96 media=video; clock-rate=90000; encoding-name=H264;
```

GStreamer

Run the following command from your terminal program, GStreamer program must be installed.

```
gst-launch-1.0 udpsrc port=56000 caps="application/x-rtp, media=video, clock-rate=90000, encoding-name=H264, payload=96" ! rtph264depay ! decodebin ! videoconvert ! autovideosink
```



- Port number, shown in red, must be the same as the RTP output you'd like to view
- Outputs are directly related to the inputs of the encoder your device is connected to.
- Suggested ports to use are 56000, 56010, 56020 & 56030



Nodestream Live Module

This feature allows sharing of your Nodestream X stream with external parties via Nodestream Live. Simply add your device to your Nodestream Live organisation and it will be available to share via a timed link or viewed by organisation members. For information on how to add your device, refer "[Server Configuration](#)" on page 10.



- Requires account and subscription to Nodestream Live
- Stream settings are controlled by the Nodestream X user, Live stream is a "slaved" view.
- When your device is not connected to an Encoder, the system idle screen will be displayed in Live

Audio

Nodestream video devices include a single Nodecom audio channel for streaming two-way audio to other Nodestream devices in the your group. The following audio devices are supported:

- USB speakerphone, headset or capture device via the USB A accessory port
- HDMI output



Audio devices are selected and configured via your Harvest control application.

Data

Up to 10 channels of serial, TCP or UDP data can be simultaneously streamed between connected devices.

This versatile function enables:

- Transaction of telemetry/sensor data to/from remote sites.
- Control of remote systems .
- Ability to access remote device web interfaces, e.g. IP camera, IOT device.
- Pass data from your Nodestream Decoder to a 3rd party device and/or local network device.

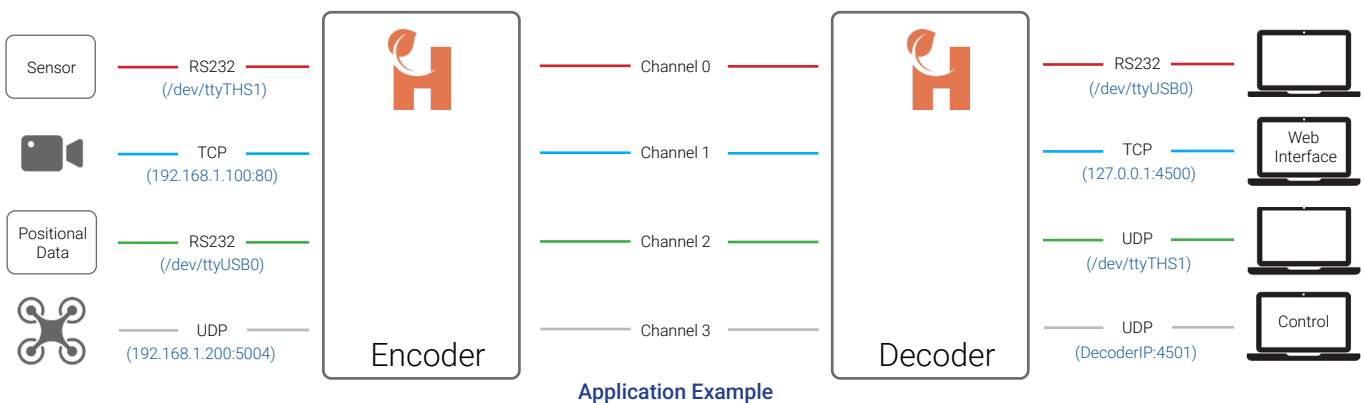

- Data channels are connected and configured via your Harvest control application.
- Streamed data should not be relied upon for critical control applications.
- Data can also be streamed in Pro Mode, refer "[Pro Mode](#)" on page 13



Control Applications

Device connections and associated input/output configurations are managed via Harvest control applications.

Nodester

A control only iOS application developed for iPad. Typically used in control applications or when a customers Nodestream group comprises only of hardware devices.

Nodestream for Windows

Windows Nodestream Decoder, audio, and control application.

Nodestream for iOS & Android

iOS and Android Nodestream Decoder, Encoder, audio, and control application.

Nodestream Live Operation

Overview

Nodestream Live is a point to cloud video and audio streaming solution that facilitates viewing of up to 16 video channels (per device) to any web enabled device connected to the Internet. A basic system comprises of;

Encoder	Ingest and Encode video/audio
Server	Manage devices, inputs, organisations, and users

Encoder Inputs

Hardware

HDMI and/or USB video sources connected to your device can be selected as inputs via device settings in your Nodestream Live web portal. For a detailed list supported input types refer "[Technical Specifications](#)" on page 18.

Network

Network sources, such as IP cameras, available on the network(s) your device is connected to can be used as inputs. Network inputs are configured via the "Inputs" page within your Nodestream Live portal. A device must be in the same organisations "location" to be available for selection on the device settings page. For more information, refer "[Network Sources](#)" on page 14



The number of network streams possible, before quality is affected depends on the source resolution and frame rate. For 16 x sources, suggested resolution is 1080 and frame rate 25, higher resolutions will effect performance.

Audio

Where audio is enabled on an configured RTSP source, the Nodestream Live Encoder will automatically detect and stream it to you Nodestream Live web portal. Audio streams can be muted/un-muted via the device settings in the portal.



Appendix

Technical Specifications

Physical

Physical dimensions (HxWxD)	65 x 160 x 130 mm (2.56" x 6.3" x 5.12")
Weight	1.6kg (3.53lbs)

Power

Input	4 pin M12 A coded - 12 to 28VDC
Consumption (operating)	7w (typical)

Environmental

Temperature	Operating: -20°C to 65°C	Storage: -20°C to 80°C
Humidity	Operating: 0% to 90% (non-condensing)	Storage: 0% to 95% (non-condensing)

Video

Input	HDMI	Resolutions up to 1920x1080 pixels Frame rates up to 60fps 4:2:0 8-bit, 4:2:2 8-bit, 4:4:4 8-bit, 4:4:4 10-bit
	USB Type A 3.0	Uncompressed YUV 4:2:0 MJPEG
Output	HDMI	Max resolution 4096x2160 @ 30Hz

Network Streams

Supported Protocols	RTSP/RTP/HTTP/UDP (MPEG, H.264, H.265)
---------------------	--

Other Interfaces

Ethernet	2 x 10/100/1000 - 8 pin M12 X coded
WiFi	802.11ac 2.4GHz/5GHz (optional adapter)
Serial	RS232 - 8 pin M12 A coded
USB	USB 3.0 type-A port
UI	Status LED Reset button

Included Accessories

Hardware	PSU	AC/DC 12V 36w with multi country adapters
	Power cable	4 pin M12 A coded to 2.5mm barrel
	Serial cable	8 pin M12 A coded tail
	LAN cable	2 x 8 pin M12 X coded to RJ45
Documentation	Quick start guide	

Certification

RCM, CE, UKCA, FCC



Troubleshooting

System

Issue	Cause	Resolution
Device not powering	Supply not connected or powered Incorrect polarity Supply outside of specified voltage	Confirm supply is connected and powered Confirm correct polarity, refer " Connections " on page 2 Confirm supply meets specifications, refer " Technical Specifications " on page 18
Unable to remotely access Web Interface	LAN port not configured Network issue Device not powered	Connect to device locally and confirm network configuration correct Refer "network" troubleshooting below Confirm device is powered on
Device operating in incorrect mode	Device "system mode" not set	Set desired system mode in Web Interface Refer " System Mode " on page 10
Device overheating	Inadequate space around heat-sink Environmental conditions	Ensure adequate ventilation (refer quick start guide) Ensure specified operating conditions are met Refer " Technical Specifications " on page 18
Keyboard and/or mouse not responding	Faulty keyboard and mouse Not plugged in	Try another keyboard and mouse Ensure device(s) or dongle correctly connected
Forgot login and/or network details	N/A	Factory reset device, refer " Reset and Support " on page 9 or Device Quick Start Guide

Network

Issue	Cause	Resolution
LAN (unplugged) message displayed	Network not connected to LAN port Incorrect/inactive port on network switch	Check an Ethernet cable is connected Confirm connected port is active and configured
"Server connection error" message displayed (No connection to server) Status LED Red	Network issue Port not configured Firewall settings Not registered to server	Check an Ethernet cable is plugged into LAN 1 Check WiFi adapter is plugged in and connected to correct WiFi network Confirm port configuration is correct Refer " Port Configuration " on page 7 Ensure firewall settings are implemented and correct. Refer " Firewall Settings " on page 8 Register your device on your Nodestream server
Unable to open video stream input	Associated network not connected and/or configured Stream source not connected and/or powered Stream URI incorrect Stream not enabled and/or configured on source device	Confirm network connected and configured Refer " Port Configuration " on page 7 Confirm stream source connected and powered Confirm URI is correct Refer " Network Sources " on page 14 Login to source interface and confirm stream is enabled and correctly configured



Video

Issue	Cause	Resolution
No output to monitor	Monitor not connected or powered Connected to incorrect port Incompatible cable or too long	Ensure monitor(s) connected and powered Test monitor with an alternative input Connect display to "OUT" port Ensure HDMI cable meets or exceeds resolution and frame rate specifications, test with a shorter cable
HDMI input not displaying video	Input source not powered Incompatible cable or too long	Ensure source is connected and powered Ensure HDMI cable meets or exceeds resolution and frame rate specifications, test with a shorter cable
Black screen displayed when USB source selected	USB device not supported	Confirm USB source meets specifications refer " Technical Specifications " on page 18 Test USB source with another device
Incorrect video source displayed	Input not selected in Harvest control application	Select the correct input source via your Harvest control application
Poor video quality	Poor input source quality Insufficient network bandwidth Input settings set low in Harvest control application Network stream source settings low Lower quality stream sub profile selected not main USB source incompatibility or USB 2.0	Test video source with another input device (monitor) Increase network bandwidth or only stream 1 input Check input configuration settings in your Harvest control application Login to network stream source device and adjust output settings Ensure main profile stream is selected in stream URI Confirm USB source meets specifications refer " Technical Specifications " on page 18 Use USB 3.0 or greater device Contact support@harvest-tech.com.au with source details

Audio

Issue	Cause	Resolution
No audio input and/or output	Device not connected Device not selected Device muted	Ensure device is connected and powered on Select correct input and/or output device in your Harvest control application Confirm device is not muted
Output volume too low	Level set too low	Increase output volume at the connected device or via your Harvest control application
Input volume too low	Level set too low Microphone obstructed or too far away	Increase mic level at the connected device or via your Harvest control application Ensure microphone is not obstructed Decrease distance to microphone
Poor audio quality	Poor cable connection Damaged device or cable Limited bandwidth	Check cable and connections Replace device and/or cable Increase available bandwidth and/or reduce bandwidth of video streams



User Resources

Contact and Support

support@harvest-tech.com.au



Harvest Technology Pty Ltd
7 Turner Ave, Technology Park
Bentley WA 6102, Australia
harvest.technology

All rights reserved. This document is the property of Harvest Technology Pty Ltd. No part of this publication may be reproduced, stored in a retrieval system or transmitted in any form or by any means, electronic, photocopy, recording or otherwise without the written consent of the CEO of Harvest Technology Pty Ltd.