

# GLASS WALLS

---



Redefine your space with the modern allure of glass walls, offering unobstructed views and an open, airy atmosphere.

---

# SECURITY & STYLE



EXPLORE OUR CUSTOM OPTIONS

## FRAMES

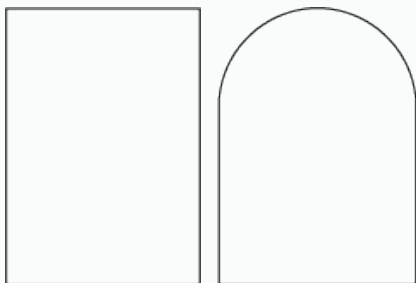

4+ Options

## GLASS

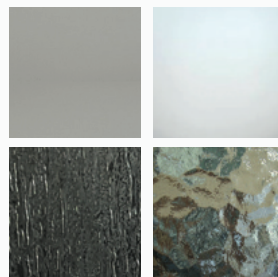

5+ Options

## FINISHES

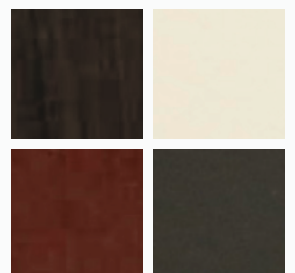

10+ Options

# CUSTOMIZATIONS

If you can dream it, we can build it. Our customization options allow you to enter a world of possibilities. You can customize design, shape, size and more to create a one of a kind masterpiece for your home.

## GLASS FRAMES

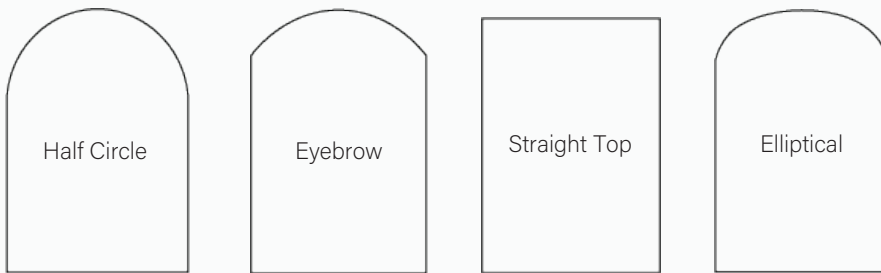

## IRON FINISHES

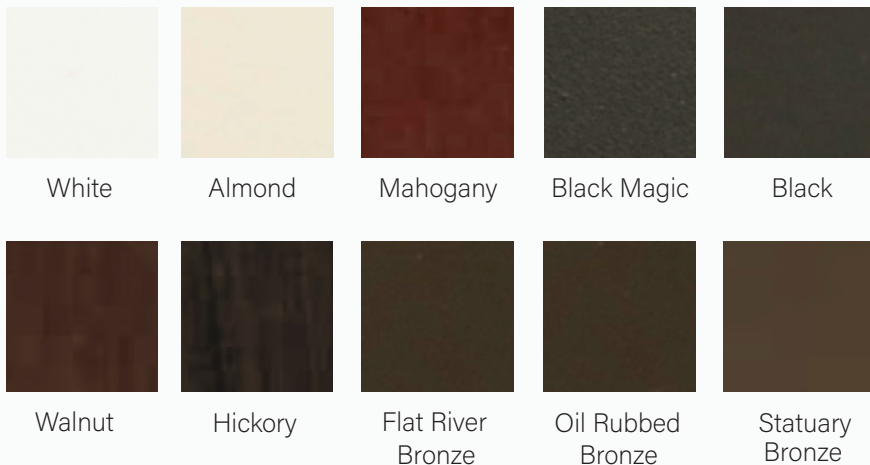

## GLASS OPTIONS

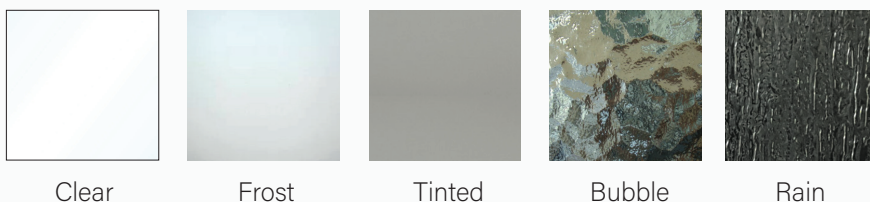

## SPOKE OPTIONS

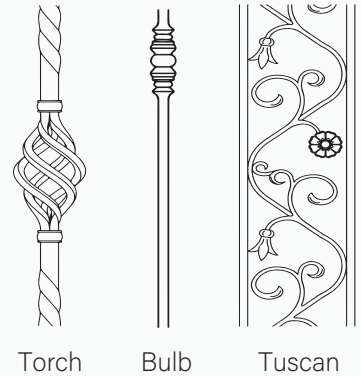

## PICKET OPTIONS

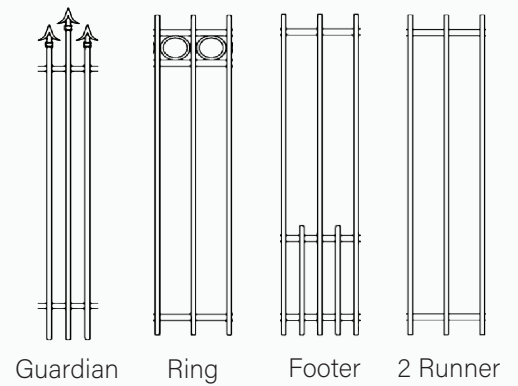

## SPIKE OPTIONS

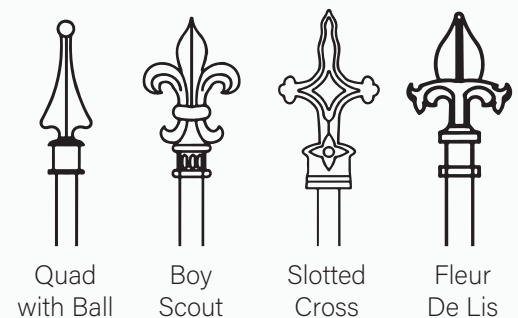

---

# *WHY CHOOSE IRONWORKS*

## AMERICAN MADE IRON & STEEL

We like to let our products speak for themselves; American made iron and steel. Our U.S.-made iron doors, windows, fences, glass patio rooms, and railings don't just add to your home; they tell its story. Each piece is infused with security and charm that will last generations to come.

## QUALITY BEYOND COMPARE: IRON & STEEL

Our doors outshine wooden alternatives in every way. Durability, security, maintenance, you name it. Choose an iron entry door from Ironworks America, and you'll find yourself at peace knowing that the beauty and stunning finish will remain for years to come.

## USA MANUFACTURING: PROUDLY MADE IN AMERICA

We manufacture all of our products in-house at our facility down in the heart of the Southeastern US. How about the other manufacturers? Well, they can't say the same. You'll find a "Made in China/Mexico" tag on the rest of them. And the difference in quality will show too -our doors last 3x longer and will look as good in 5 years as they do the day we install them.

## STRENGTH RIVALED BY NONE: 12 GAUGE STEEL

At Ironworks America, we prioritize strength. Unlike the other manufacturers, we use 12-gauge steel, which is significantly stronger than the 14-gauge used by most competitors. 12-gauge steel is 3x stronger while only being a few hundredths of an inch thicker. This ensures unparalleled durability in our products.

## YOUR VISION REALIZED: FULLY BESPOKE SOLUTIONS & CUSTOM SIZING

Every product we make is made to order. Unlike others, we don't sell precut doors that we hope fit your home. We measure and size each door to custom-fit your home for a seamless installation. Each door can be customized down to the tiniest detail. Mix and match styles or create your own.

---

## WHAT TO EXPECT

01

QUOTE

Reach out and tell us which product(s) you're interested in, as well as any customizations or add-ons you want. We'll total all of the options and build a quote for you to review.

02

MEASURE

After delivering your quote and getting confirmation, we come to your home to measure the space(s) you want your products to be installed in.

03

DESIGN

We send the measurements of your spaces and your item selection & add-ons to our design team to draft options that show what your product will look like in your home.

04

BUILD

We send the design to our production floor where our skilled artisans will make your design dream a reality.

05

INSTALL

Once your product is complete and has gone through our numerous quality checks, our professional installers will be on-site at your convenience to install your product.

# FAQ'S

---

## WHAT GEOGRAPHIC AREAS DO YOU SELL TO?

We sell to the greater Southeast area with a focus on Tennessee, South Carolina, Arkansas, North Carolina, Alabama, and Mississippi.

## HOW QUICKLY ARE PRODUCTS DELIVERED & INSTALLED?

For most of our products, we can deliver within 4 weeks or less. Custom doors and other products will take 4-6 weeks.

## ARE THERE WARRANTY OPTIONS FOR PRODUCTS?

- Lifetime structural warranty
- Five year paint warranty on all non-wood stain finishes
- Three year paint warranty on wood stain finishes
- EMTEK locks under warranty through EMTEK

## DOES IRONWORKS AMERICA OFFER PAYMENT PLANS?

Yes, we offer financing through several institutions.

## HOW DO I GET AN ESTIMATE & IS IT FREE?

You can request a quote through the website or call the office. All quotes are free.

## DO YOU PROVIDE CUSTOM OPTIONS?

Yes, we provide custom options on all of our products.

## WHERE ARE YOUR PRODUCTS MADE?

We manufacture all our products in the US at our Mississippi manufacturing facility.

## HOW DOES IRONWORKS AMERICA COMPARE TO COMPETITORS?

Unlike other door companies who outsource their manufacturing to China, we manufacture all our products in the US at our Mississippi manufacturing facility. For comparison, our doors are often 1/2-1" thicker than our competitors.