



550 USt



279 ft



335 ft



433 ft

The big fast-erecting crane!

LTM 1450-8.1

Mobile crane
Grue mobile

LIEBHERR

Mobile and crawler cranes



Technical data

Caractéristiques technique

Dimensions	
Encombrement	3
Mobile crane	
Grue mobile	4-5
Liebherr SingleEngine Concept	
Concept de moteur unique Liebherr	6
Crane data	
Dates de la grue	7
VarioBallast	8
Counterweight	
Contrepoids	9
On-road driving	
Déplacement sur route	10-11
High luffing jib lifting capacity	
Des capacités de charge élevées avec la pointe basculante	12
Increase in lifting capacity using the luffing jib	
Augmentation de la capacité de charge via la pointe de flèche de relevage	13
Boom/jib combinations	
Configurations de flèche	14-16
T	17-20
TK	21-36
TF	37-75
TN	76-96
Equipment	
Équipement	97-98
Description of symbols	
Explication des symboles	99
Remarks	
Remarques	100

Dimensions Encombrement

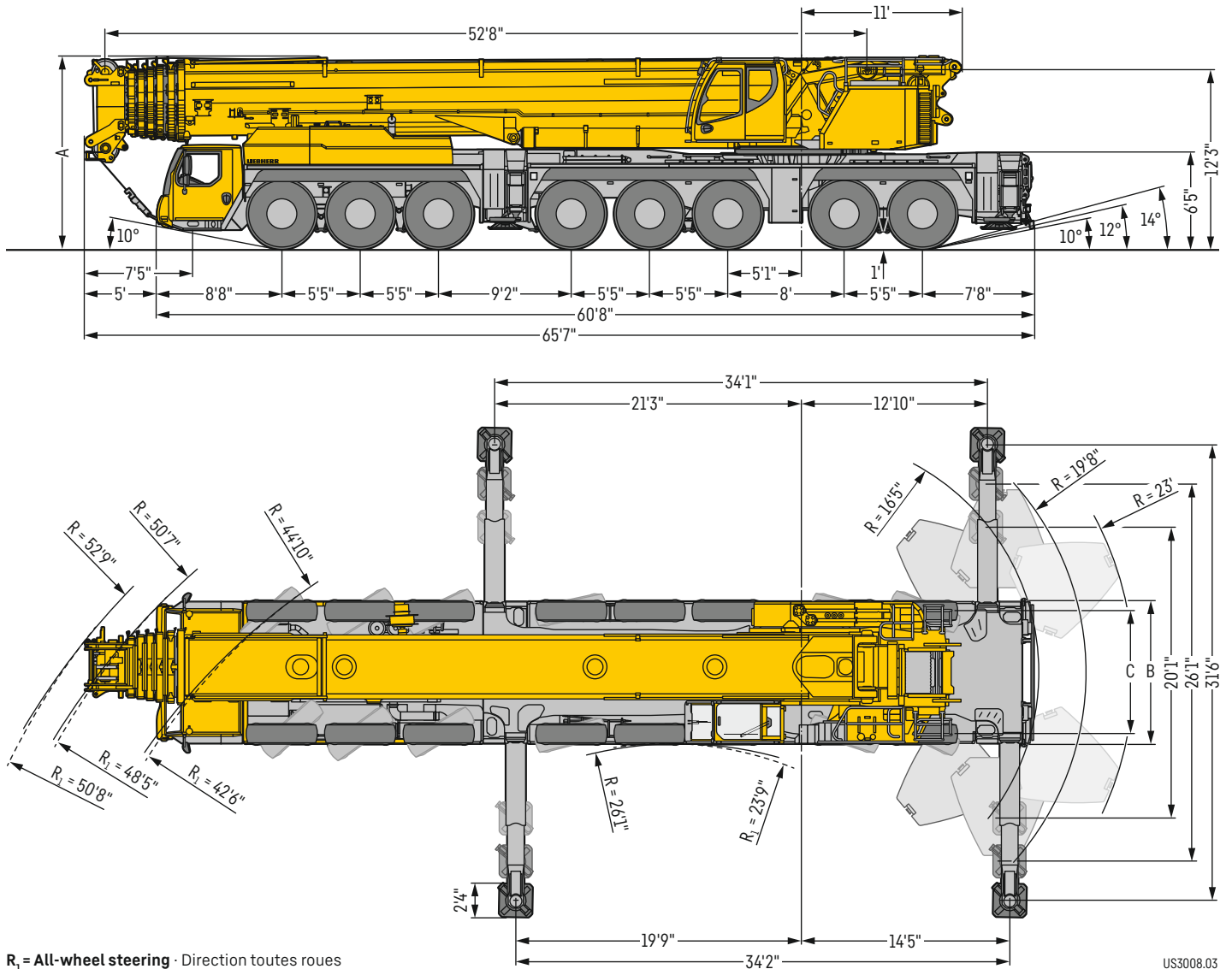

R₁ = All-wheel steering · Direction toutes roues

US3008.03

Dimensions · Encombrement

	A	A*	B	C
445/95 R 25 (16.00 R 25)	13'1"	12'10"	9'10"	8'4"
525/80 R 25 (20.5 R 25)	13'1"	12'10"	10'2"	8'5"

* lowered · abaissé

LTM 1450-8.1



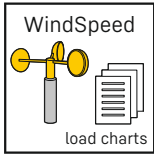

Increased flexibility and safety by using lifting capacity tables with different maximum wind speeds.

Une flexibilité et une sécurité accrues grâce aux tableaux de charge avec différentes vitesses de vent autorisées.

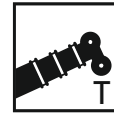

279 ft



46 ft - 276 ft



23 ft - 184 ft

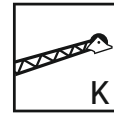

23 ft - 115 ft



VarioBallast
295,400 lb

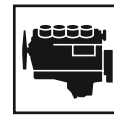

505 kW (686 h.p.)

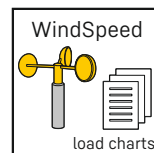
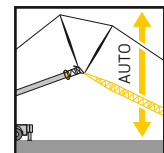
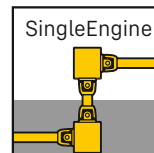
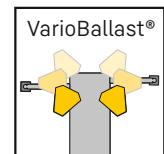
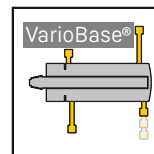

Liebherr SingleEngine concept

Concept de moteur unique Liebherr

Liebherr-8-cylinder engine 505 kW/686 h.p.
Moteur 8 cylindres Liebherr 505 kW/686 CH



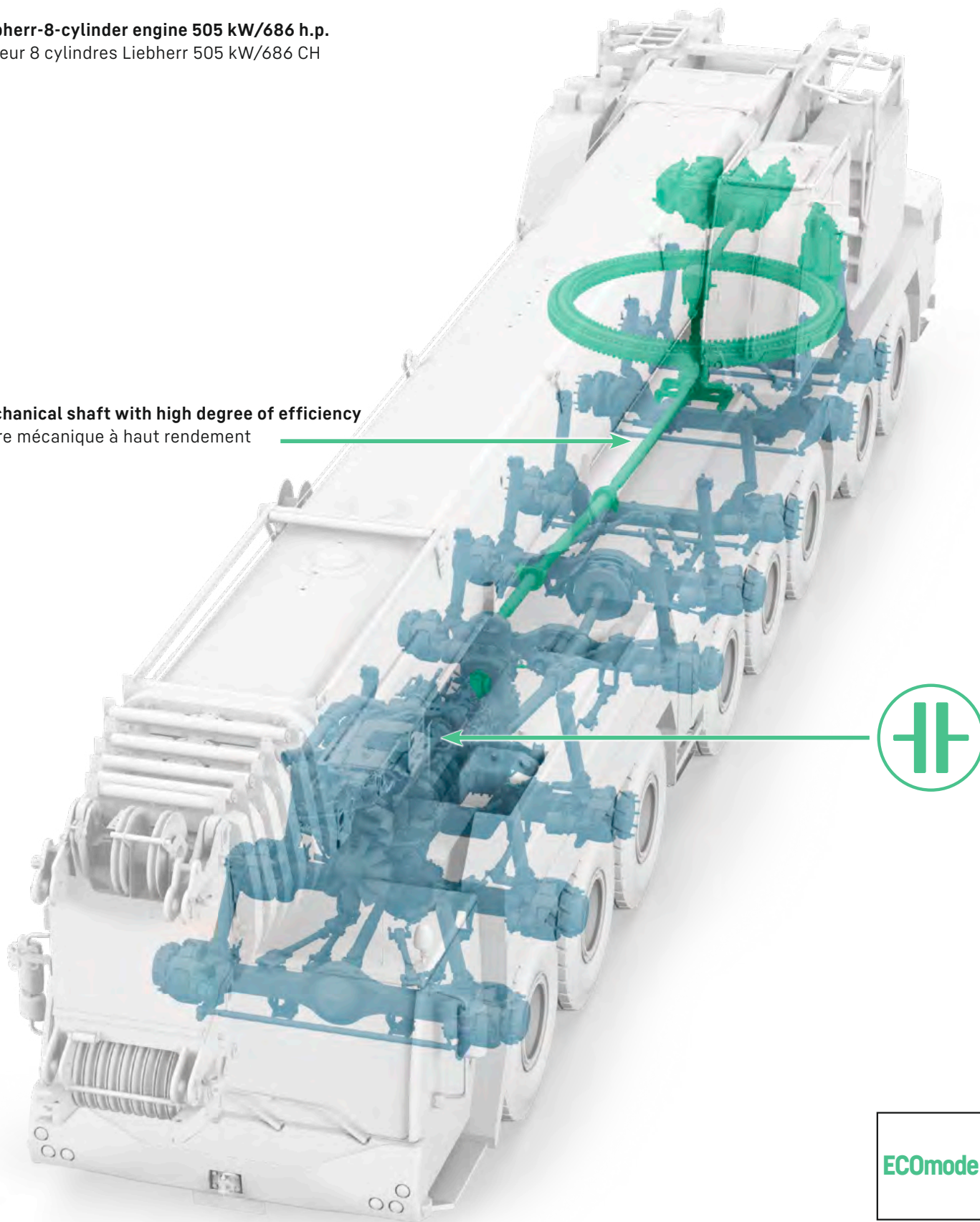

Mechanical shaft with high degree of efficiency
Arbre mécanique à haut rendement









Crane data

Dates de la grue

Hook block - Moufles à crochet

			
527,600 lb	11	22	8,160 lb
444,200 lb	9	18	7,275 lb
378,300 lb	7	15	5,950 lb / 7,720 lb
285,700 lb	5	11	5,070 lb / 6,830 lb
187,100 lb	3	7	3,970 lb / 5,730 lb
82,600 lb	1	3	3,090 lb
28,000 lb	-	1	1,550 lb

Crane carrier - Châssis porteur







	 min.	 max.	 %		
445/95 R 25 (16.00 R 25)	1.2	53	39,5 %		12 / R2
525/80 R 25 (20.5 R 25)	1.2	53	39,5 %		

Theoretical gradeability - Aptitude théorique en pente

Max. supporting forces - Forces d'appui max.

		
F _{max}	341,000 lb	449,000 lb

Crane superstructure - Partie tournante

			
 0 - 430 m/min single line - au brin simple	25 mm	1705 ft	28,325 lb
 0 - 502 m/min single line - au brin simple	25 mm	3035 ft	28,325 lb
 0 - 1.3 rpm			
 approx. 80 seconds to reach 83.5° boom angle env. 80 s jusqu'à 83,5°			
 approx. 731 seconds for boom extension from 53 ft - 279 ft env. 731 s pour passer de 53 ft - 279 ft			

VarioBallast

<p>295,400 lb</p>	<p>16 ft 5 in</p>
	<p>19 ft 8 in</p>
	<p>23 ft</p>

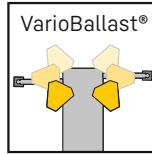

<p>16 ft 5 in</p>

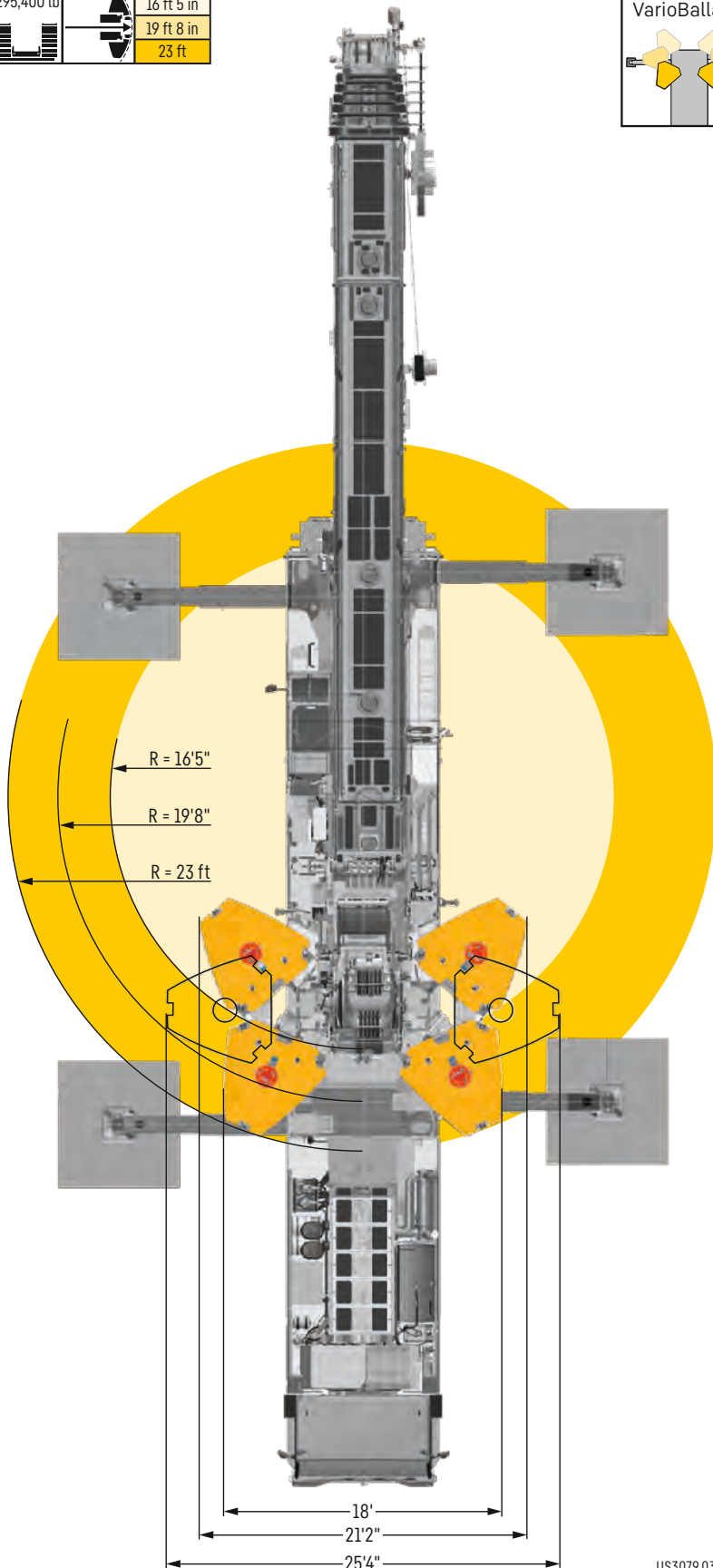

<p>19 ft 8 in</p>



<p>23 ft</p>



US3079.03

Counterweight Contrepoids

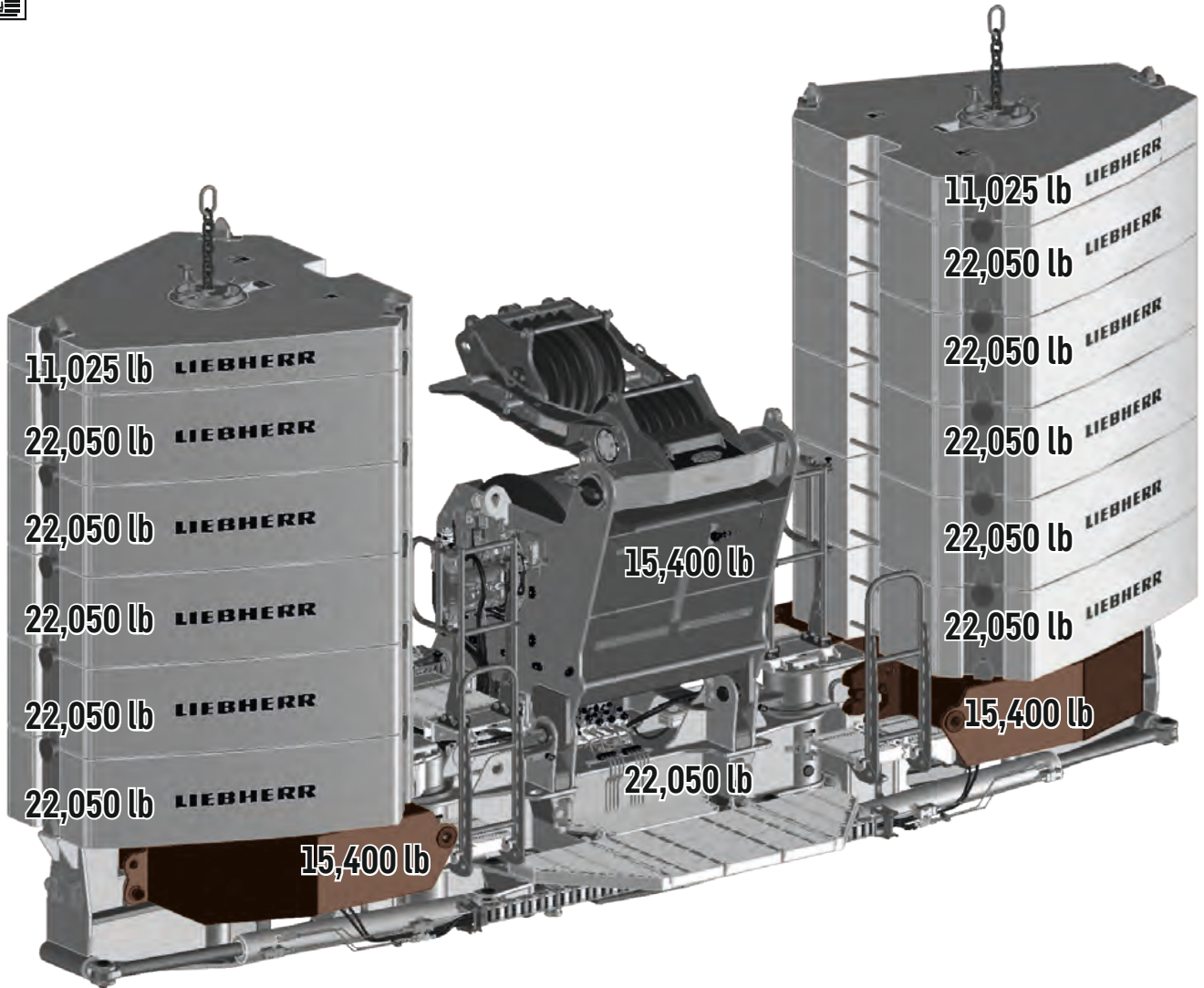

**Improved for transport & logistics – Uniform ballast plates,
compatible with many other crane models**

Optimisé pour le transport et la logistique : plaques de
lest de forme identique, compatibles avec de nombreux autres
types de grue

On-road driving

Déplacement sur route

< 105,800 lb

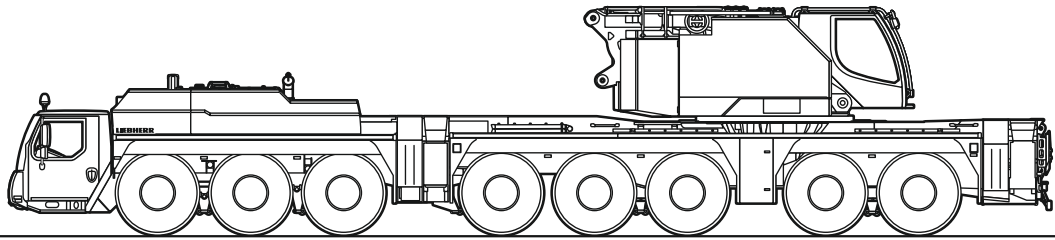

≤ 13,250 lb ≤ 13,250 lb ≤ 13,250 lb ≤ 15,450 lb ≤ 15,450 lb
 ≤ 13,250 lb ≤ 15,450 lb ≤ 15,450 lb

< 114,650 lb

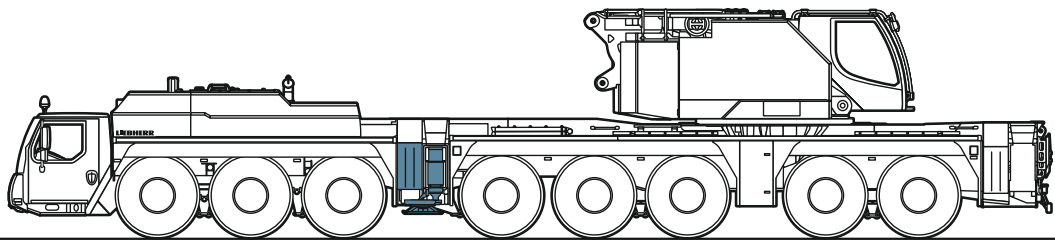

≤ 13,250 lb ≤ 13,250 lb ≤ 13,250 lb ≤ 17,650 lb ≤ 17,650 lb
 ≤ 13,250 lb ≤ 17,650 lb ≤ 17,650 lb

< 123,500 lb

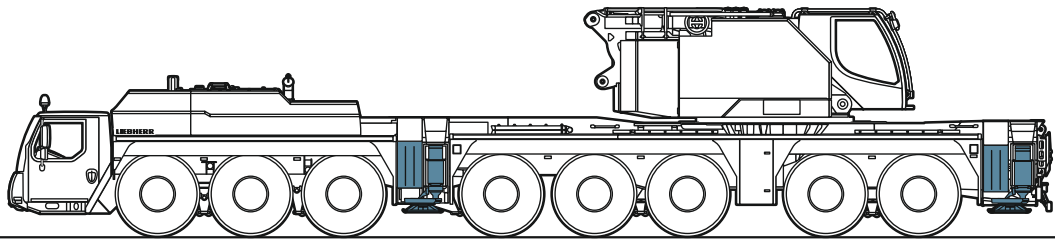

≤ 13,250 lb ≤ 13,250 lb ≤ 13,250 lb ≤ 19,850 lb ≤ 19,850 lb
 ≤ 13,250 lb ≤ 19,850 lb ≤ 19,850 lb

< 123,500 lb

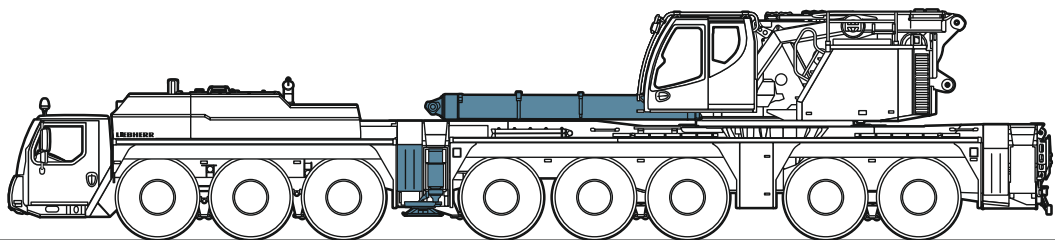

≤ 13,250 lb ≤ 13,250 lb ≤ 13,250 lb ≤ 19,850 lb ≤ 19,850 lb
 ≤ 13,250 lb ≤ 19,850 lb ≤ 19,850 lb

< 132,300 lb

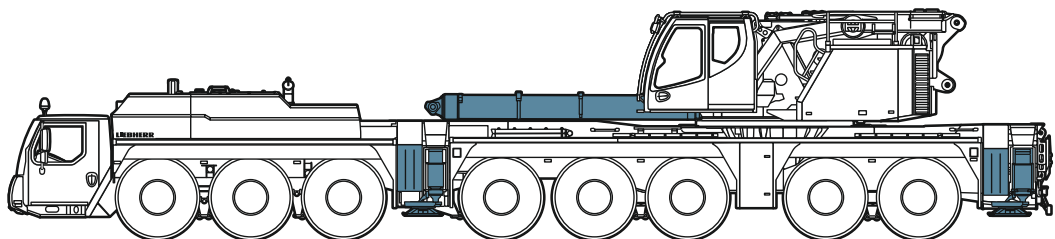

≤ 11,025 lb ≤ 11,025 lb ≤ 11,025 lb ≤ 24,250 lb ≤ 24,250 lb
 ≤ 11,025 lb ≤ 24,250 lb ≤ 24,250 lb

On-road driving

Déplacement sur route

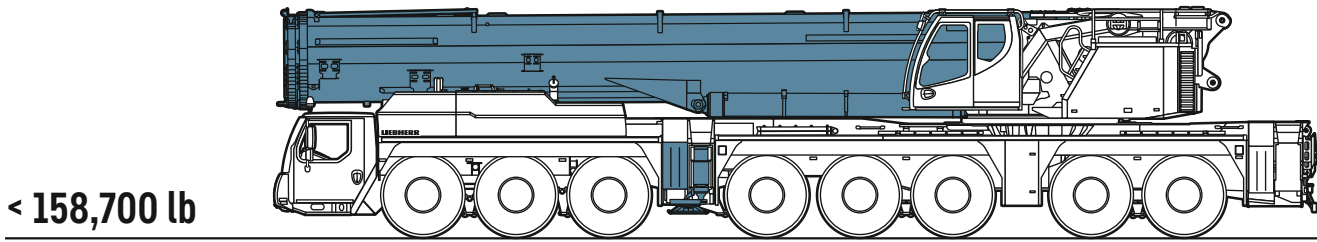

$\leq 19,850 \text{ lb}$ $\leq 19,850 \text{ lb}$ $\leq 19,850 \text{ lb}$ $\leq 22,050 \text{ lb}$ $\leq 22,050 \text{ lb}$
 $\leq 19,850 \text{ lb}$ $\leq 22,050 \text{ lb}$ $\leq 22,050 \text{ lb}$

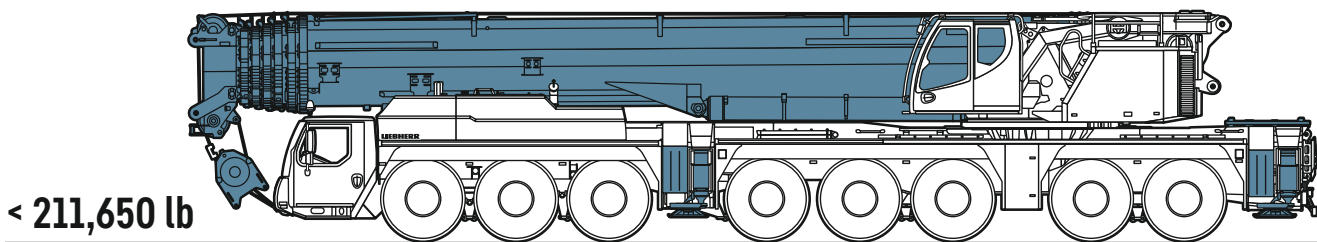

$\leq 26,450 \text{ lb}$ $\leq 26,450 \text{ lb}$ $\leq 26,450 \text{ lb}$ $\leq 26,450 \text{ lb}$ $\leq 26,450 \text{ lb}$
 $\leq 26,450 \text{ lb}$ $\leq 26,450 \text{ lb}$ $\leq 26,450 \text{ lb}$

Jobsite driving

Déplacement sur chantier

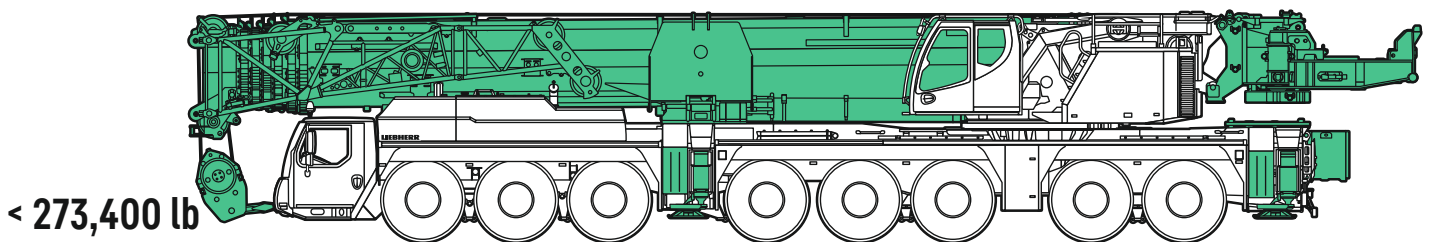

$\leq 33,075 \text{ lb}$ $\leq 33,075 \text{ lb}$ $\leq 33,075 \text{ lb}$ $\leq 36,400 \text{ lb}$ $\leq 36,400 \text{ lb}$
 $\leq 33,075 \text{ lb}$ $\leq 36,400 \text{ lb}$ $\leq 36,400 \text{ lb}$

US3226.01

High luffing jib lifting capacity

Des capacités de charge élevées avec la pointe basculante

TN

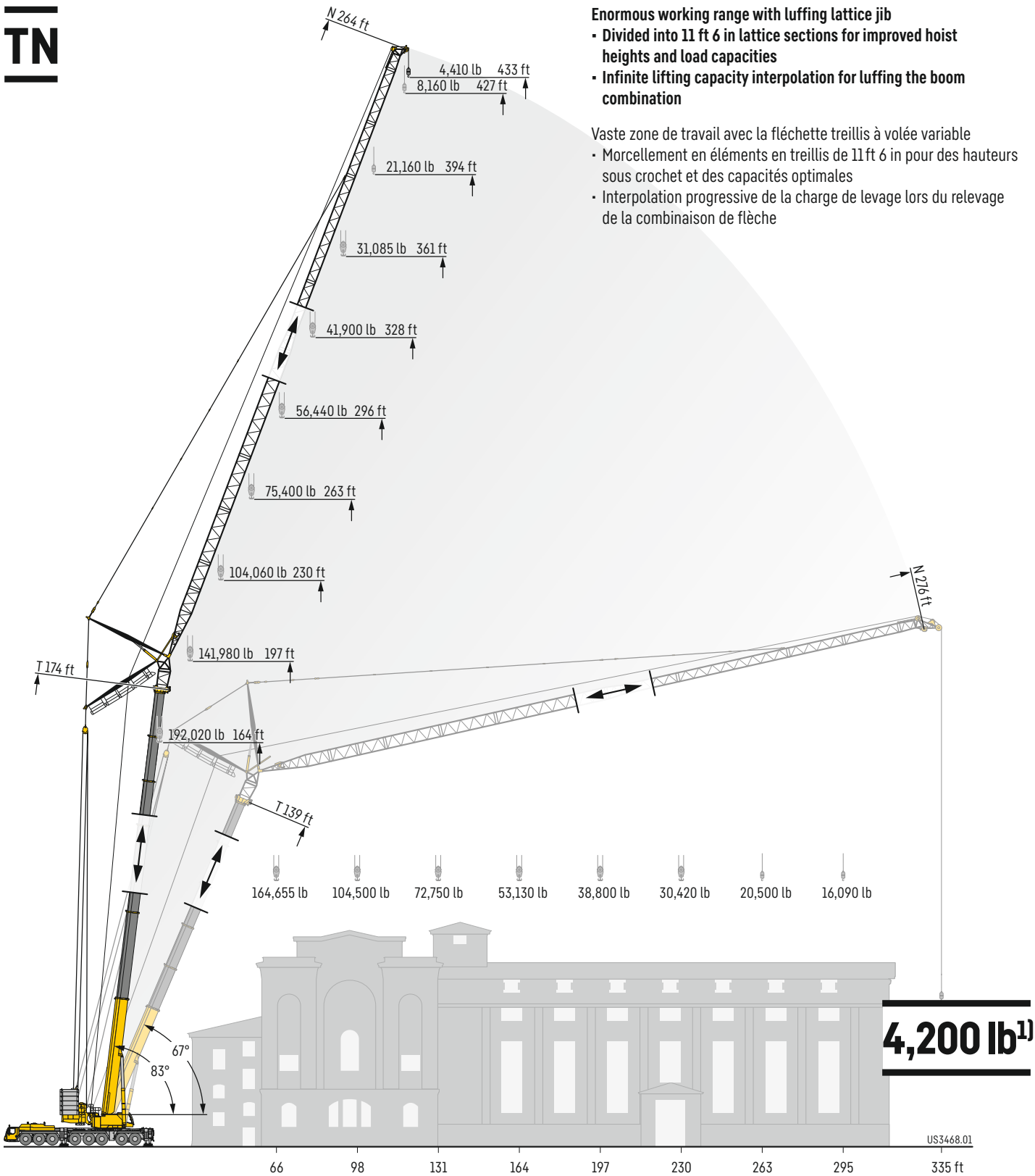

Infinite lifting capacity interpolation · Interpolation progressive de la charge de levage

¹⁾ TNH

Increase in lifting capacity using the luffing jib

Augmentation de la capacité de charge via la pointe de flèche de relevage

Lifting capacity increases of up to more than 50 % can be achieved with the same hook height using the luffing lattice jib, which can be installed quickly and easily

Grâce à la fléchette treillis basculante rapide à monter, les augmentations de capacité de charge peuvent atteindre jusqu'à plus de 50 % pour une même hauteur sous crochet.

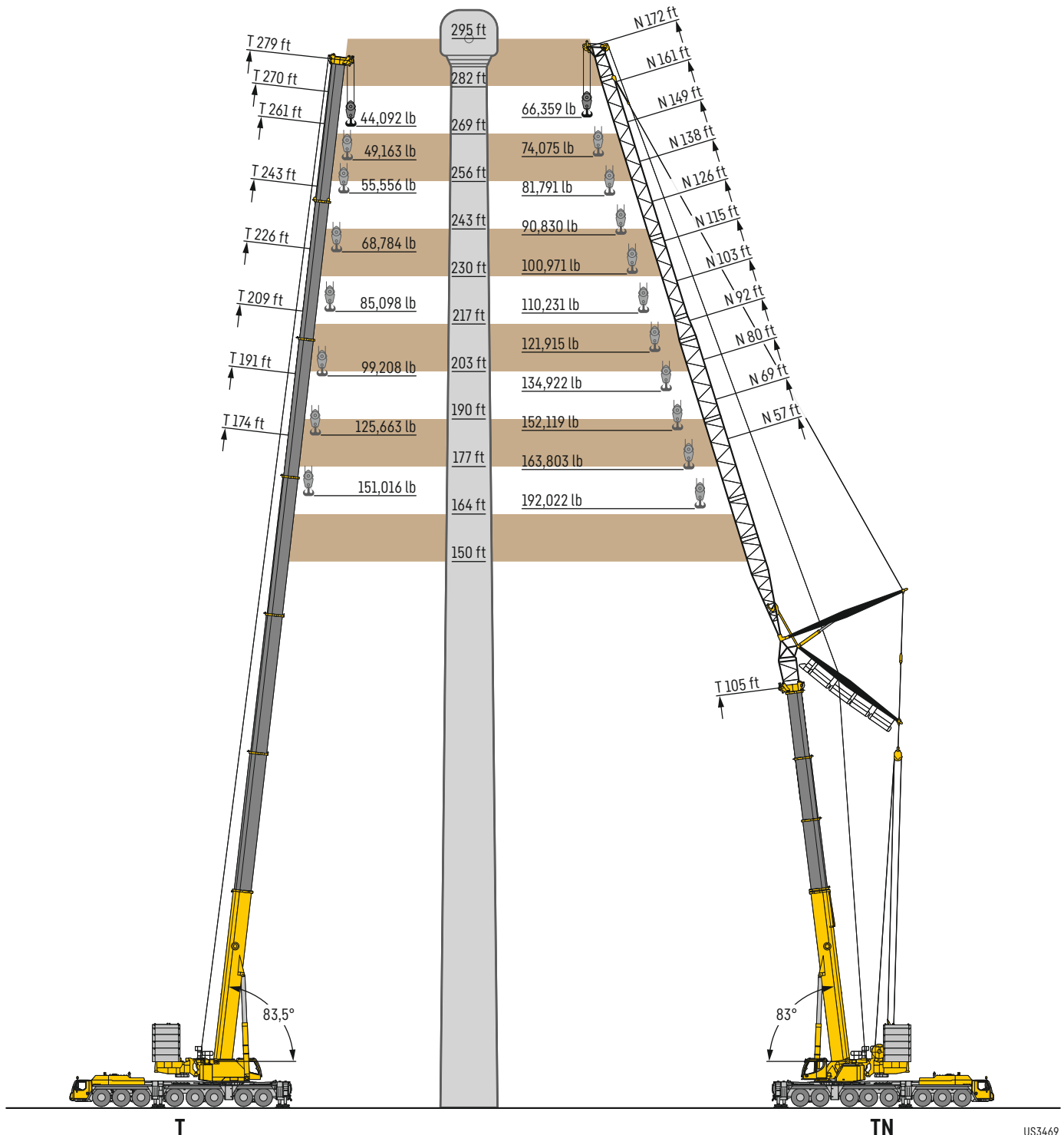







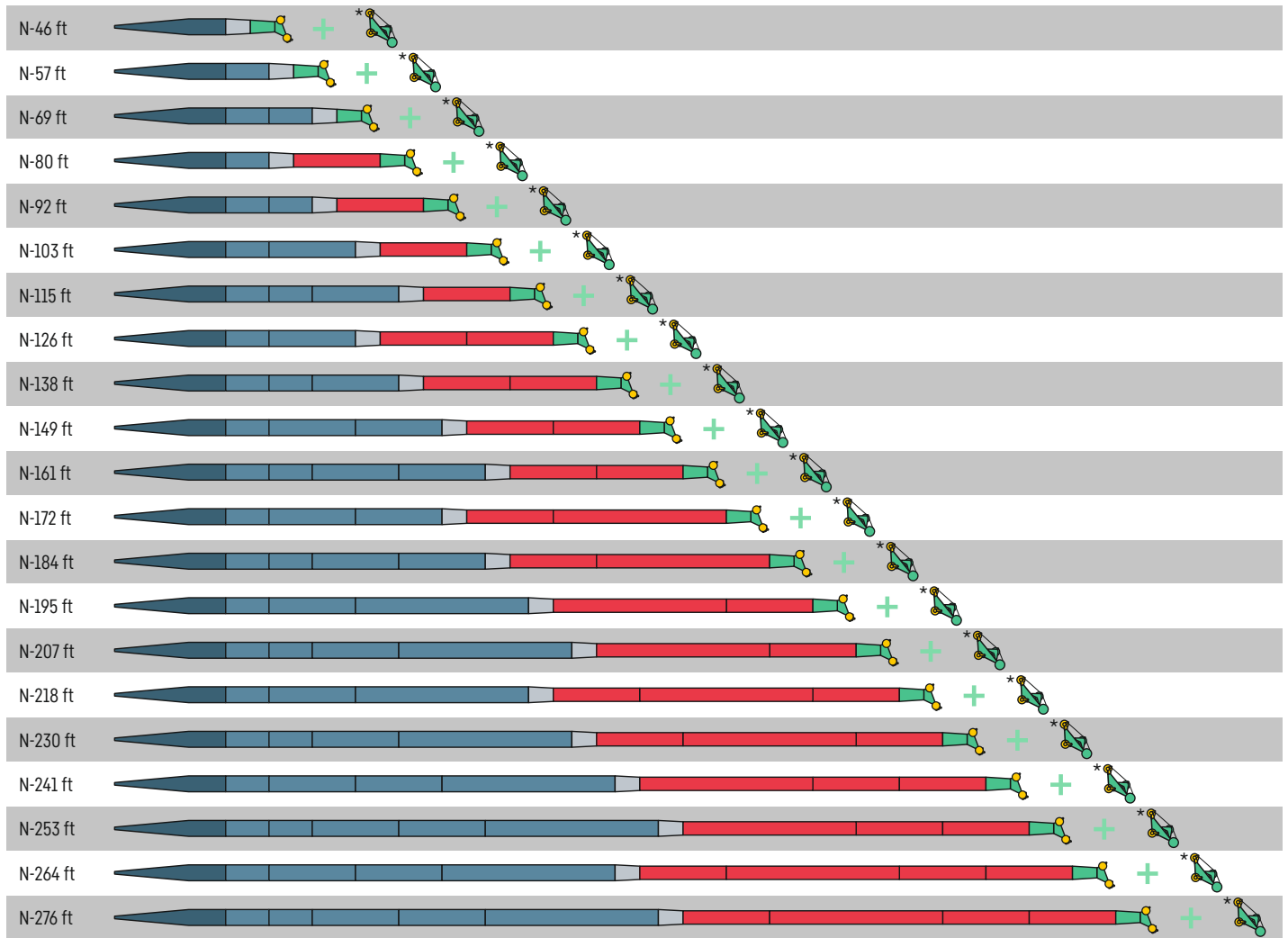

US3469

Boom/jib combinations – Luffing fly jib

Configurations de flèche – Fléchette à volée variable











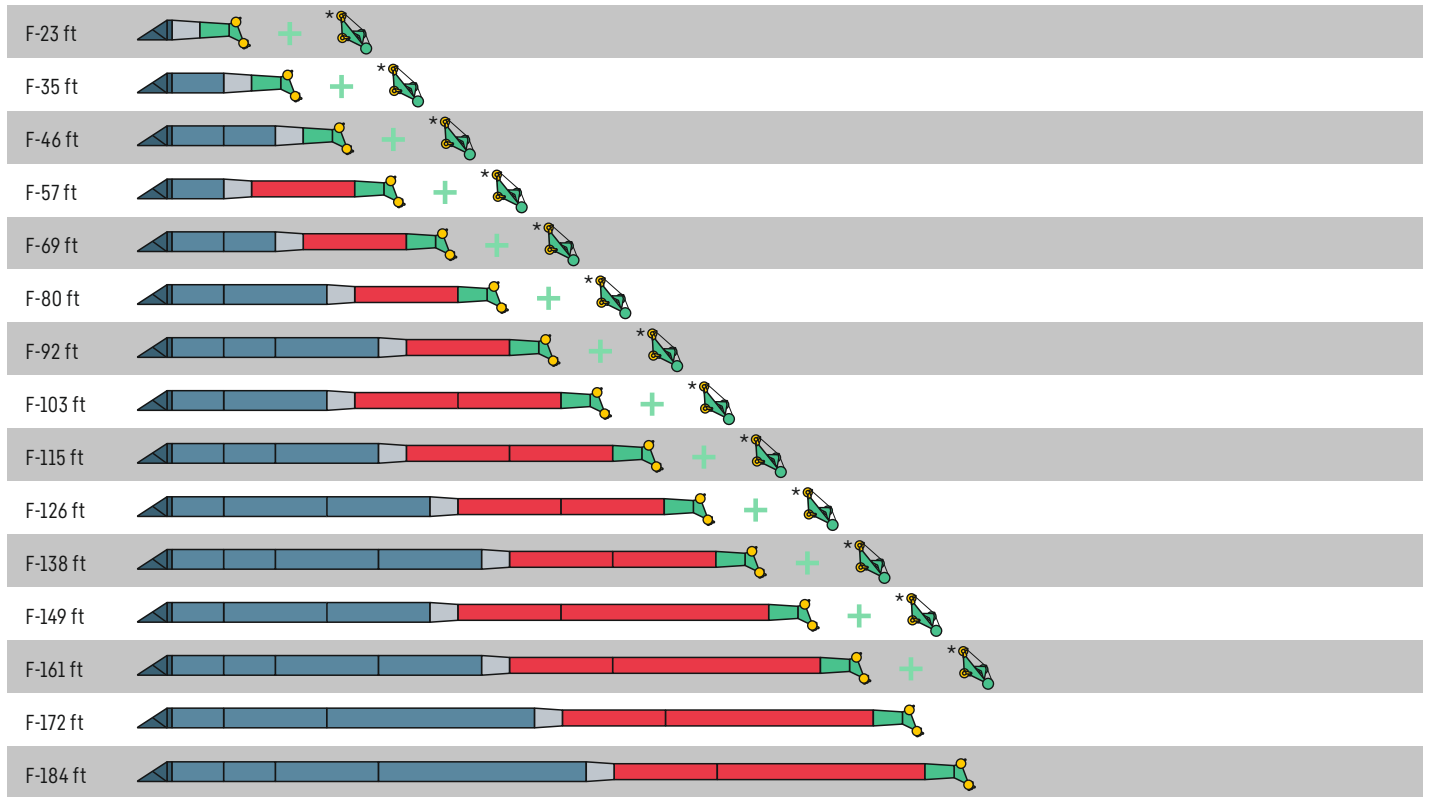

-  29'6" N-shaped base section - Élément de base N
-  NA-11'6"
-  NA-23'
-  NA-46'
-  6'7" NI reduction section - Élément réducteur NI
-  NI-23'
-  NI-46'
-  9'10" N head section - Élément de tête N
-  * 4'11" H auxiliary jib optional - Fléchette auxiliaire H en option

US3070.01

Boom/jib combinations – Fixed fly jib

Configurations de flèche – Fléchette fixe



-  6'7" TF-adapter - TF-adaptateur
-  NA-11'6"
-  NA-23'
-  NA-46'
-  6'7" NI reduction section - Élément réducteur NI
-  NI-23'
-  NI-46'
-  9'10" N head section - Élément de tête N
-  4'11" H auxiliary jib optional - Fléchette auxiliaire H en option

US3068.01

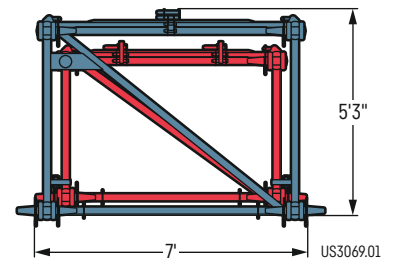
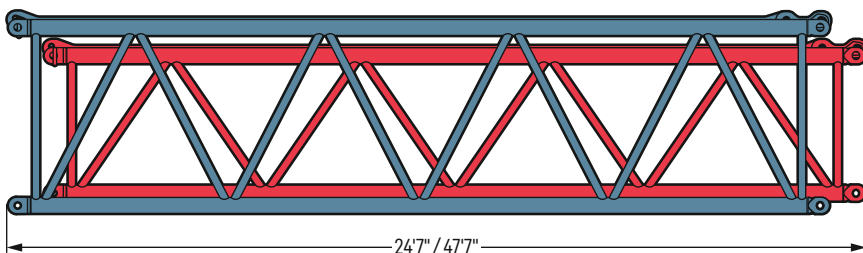

Boom/jib combinations

Configurations de flèche

T Telescopic boom - Flèche télescopique

K Swing away jib - Fléchette pliante

F Fixed lattice jib - Fléchette treillis fixe

N Luffing fly jib - Fléchette treillis à volée variable

H 5 ft H auxiliary jib optional, dependent on boom system
Fléchette auxiliaire H en option, selon le système de flèche



S3012.02

Lifting heights

Hauteurs de levage

T

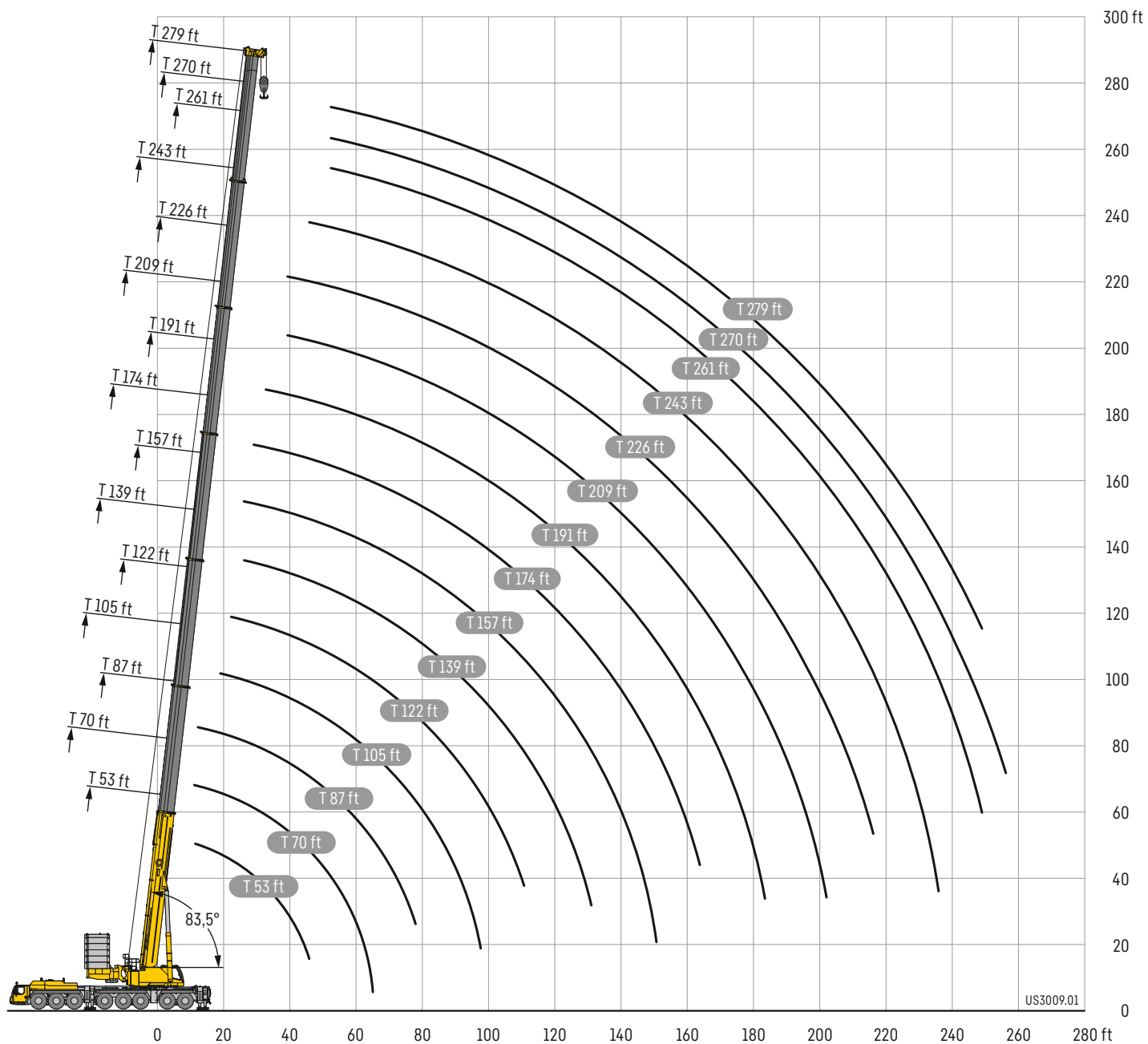

Lifting capacities

Forces de levage

T

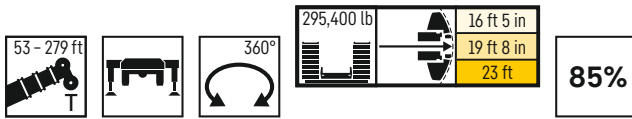

	53ft	70ft	87ft	105ft	108ft	122ft	139ft	145ft	157ft	163ft	174ft	183ft	191ft	201ft	209ft	218ft	226ft	235ft	241ft	243ft	253ft	259ft	261ft	270ft	276ft	279ft		
	*																											
10	992.1	444.3	426.4																								10	
11	747.3	444.3	427.4																									11
12	527.6	444.3	428.4	415.6																								12
13	527.6	444.3	429.7	416.7																								13
14	527.6	444.3	431.1	417.7	361.1																							14
15	527.6	444.3	433	418.8	404.9																							15
16	527.6	444.3	434.7	419.7	400.5	194.4																						16
17	527.6	444.3	436.6	420.6	396	190.6																						17
18	527.6	444.3	438.3	421	392.2	186.5	365.8																					18
19	527	444.3	440.1	421.2	387.7	181.7	362.2																					19
20	525.1	443.6	441.2	421.4	384	177.6	356.9																					20
22	489.2	425.8	424.8	414.8	370.4	168.9	347.3	274.9																				22
24	448.2	397.8	397.4	388.5	366.2	161.1	336.6	266.5	116.5	166.4																		24
26	412.7	372.6	372.3	369.1	358.2	153.9	326	257.9	112.8	228.2	100.2																	26
28	382.3	349.8	351.8	347.9	336.4	146.8	316.1	248.3	109.2	221.7	97.4	154.6																28
30	358.8	328.8	330.3	327.9	318	139	305	240.2	105.5	214.3	94.6	149.6	85															30
32	332.2	309.1	310.7	310.4	300	132.1	291.6	232.3	102.1	207.8	91.5	145.3	83.3	126.9														32
34	311.5	291.4	294.3	293.3	283.9	127.1	276.6	226	99.1	200.6	88.7	140.3	81.4	123.7	75.2													34
36	292.9	275.6	278.5	278.7	269.2	122	262.9	219.1	95.9	194.5	86	136	79.3	120.5	73.7	103												36
38	276.1	261	264.2	264.3	257.6	117.4	250.4	212.2	93.1	188.2	83.6	132.5	77.4	117.5	72.3	100.5	69											38
40	261.1	247.8	250.8	251.3	245.3	112.4	239.1	206	90.3	182.7	81.3	129.7	75.2	114.8	70.8	98.5	67.7	84.6										40
45	228.8	219	222.3	222.4	219.8	101.3	213.6	191	83	167.9	76.1	122.9	71	108	67.4	92.7	64.9	80.4	61	57.4	69.4	57						45
50			197.4	197.5	197.3	93.2	191.2	179.6	77.7	153.4	70.7	115.8	67.3	102.6	64	87.2	62	76.2	58.5	55	66.8	55.3	51	56.4	49.7			50
55			176.2	176.4	177.5	85.6	172.5	167.9	72.7	143.4	66.3	109.4	63.4	97	60.8	82.5	59.4	72.1	56.3	52.8	63.8	53.4	49.2	54.7	48.5	45.4	43.6	55
60			158.4	158.1	159.5	78	156.5	155.6	67.6	133.1	62.3	104.3	59.8	91.4	57.7	78.6	56.7	68.6	54	50.7	61.2	51.6	47.6	53.1	47.1	44	42.2	60
65			132.9	144	144.1	72.4	142.4	142.9	63.2	122.8	58.2	99.5	56.9	86.7	54.6	74.8	54.1	65.2	51.9	48.7	58.5	49.8	45.9	51.5	45.9	42.7	40.7	65
70				132.1	131.5	67.5	129.5	131.3	59.6	114.6	54.4	94.8	54	82.8	51.9	70.9	51.6	62.5	50.1	46.6	56	48.2	44.4	49.6	44.5	41.3	39.4	70
75				120.9	120.2	62.8	120.9	121.1	56.1	108.1	51.2	90.3	51.1	78.8	49.7	67.8	49.2	59.6	48	44.7	53.2	46.6	42.8	47.7	43.1	40	37.9	75
80				111.5	110.6	58.8	113.4	112	52.4	101.4	48.2	86.6	48.1	74.7	47.3	64.8	47.3	57.1	46	42.7	50.7	44.9	41.1	45.6	41.8	38.7	36.5	80
85					102.1	55.5	105.2	103.5	48.8	94.9	45.3	83.2	45.8	71.1	44.9	61.9	45.5	55	44.4	40.8	48.1	43.3	39.7	43.5	40.5	37.5	35.1	85
90					94.8	52.2	97.6	95.8	46.5	88.5	42.4	79.9	43.6	68	42.8	59	43.5	52.8	42.7	39.2	46	41.9	38.2	41.6	39.2	36.2	33.7	90
95					88.3	49.5	90.9	89.2	44.2	83.4	39.5	76.6	41.5	65.3	40.8	56.3	41.7	50.6	41.3	37.5	44.3	40.5	36.8	39.8	37.7	35	32.3	95
100					67.2	47	85	83.2	41.9	78.9	37.4	73.3	39.3	62.5	39	54.1	39.9	48.5	39.8	35.9	42.7	39.3	35.8	38	36.4	33.8	31	100
105						79.7	77.8	79.7	39.6	74.5	35.5	70.1	37.2	59.8	37.3	52	38.3	46.4	38.2	34.3	41	38.1	34.2	36.4	35	32.6	29.8	105
110						74.8	72.7	77.7	37.7	69.9	33.6	67.3	35.2	57.1	35.5	49.9	36.8	44.8	36.7	32.8	39.3	36.8	32.8	34.8	33.6	31.4	28.7	110
115						69.9	68.1	72.7	36.2	65.6	31.8	64.4	33.6	54.5	33.8	47.9	35.4	43.2	35.4	31.3	37.8	35.5	31.6	33	32.2	30.2	27.5	115
120								64.1	34.6	61.4	29.9	61.5	32.1	52.3	32.1	45.8	34	41.6	34.2	30.1	36.5	34.3	30.2	31.5	30.7	29	26.3	120
125								60.3	33	57.6	28.5	58.7	30.6	50.2	30.6	43.8	32.5	39.9	32.8	28.8	35.4	33.2	29.2	30	29.3	27.9	25.2	125
130								57	31.8	55.1	27.2	56	29.1	48.1	29.3	42	31	38.4	31.6	27.6	34.1	32.2	28.1	28.7	28	26.8	24	130
135									30.6	53.2	25.8	53.2	27.7	46	28.1	40.4	29.7	36.8	30.3	26.3	32.9	31	27.1	27.4	26.8	25.7	23	135
140									30	51.9	24.5	50.2	26.6	44	26.8	38.8	28.7	35.4	29	25.1	31.7	29.9	26	26.2	25.7	24.6	22	140
145										50.1	23.5	47.3	25.5	42.2	25.6	37.2	27.6	34	27.7	23.8	30.5	28.9	25	24.9	24.5	23.5	21.1	145
150										43.6	22.5	44.6	24.5	40.5	24.4	35.6	26.6	32.8	26.6	22.7	29.3	27.8	24	23.7	23.5	22.5	20.2	150
155											21.6	42.2	23.4	38.8	23.4	34.1	25.6	31.6	25.6	21.6	28.2	26.7	22.9	22.4	22.3	21.4	19.4	155
160												39.9	22.4	37.1	22.5	32.7	24.5	30.3	24.6	20.6	27.1	25.7	22	21.2	20.4	18.5	160	
165												37.8	21.7	35.4	21.6	31.5	23.5	29.1	23.5	19.6	26.2	24.8	21.1	20.1	20.2	19.3	17.6	165
170													21	34.1	20.7	30.4	22.7	27.9	22.5	18.6	25.2	23.9	20.2	19	19.1	18.3	16.7	170
175													20.4	32.6	19.8	29.2	22	26.9	21.5	17.6	24.2	23	19.4	18	18.1	17.4	15.8	175
180														30.8	19	28	21.2	26	20.5	16.6	23.2	22.2	18.6	17.1	17.2	16.4	15	180
185														25.9	18.3	26.9	20.5	25.1	19.7	15.7	22.2	21.3	17.7	16.1	16.3	15.6	14.3	185
190															17.6	26	19.7	24.2	18.9	15	21.4	20.4	16.9	15.2	15.4	14.8	13.6	190
195															17.2	25	19	23.3	18.2	14.3	20.7	19.7	16.1	14.2	14.5	13.9	12.9	195
200																23.3	18.5	22.4	17.4	13.6	19.9	18.9	15.3	13.3	13.6	13.1	12.2	200
205																	17.9	21.7	16.6	12.9	19.2	18.3	14.7	12.6	12.7	12.3	11.5	205
210																		21	15.9	12.1	18.5	17.7	14.1	11.9	12	11.5	10.8	210
215																			20.3	15.4	11.6	17.8	17	13.5	11.2	11.4	10.8	215
220																				15.3	14.9	11.1	17.3	16.4	12.9	10.6	10.8	220
225																					14.3	10.7	16.8	15.8	12.3	9.9		

Lifting capacities

Forces de levage

	53 ft	70 ft	87 ft	105 ft	108 ft	122 ft	139 ft	145 ft	157 ft	163 ft	174 ft	183 ft	191 ft	201 ft	209 ft	218 ft	226 ft	235 ft	241 ft	243 ft	253 ft	259 ft	261 ft	270 ft	276 ft	279 ft		
10	444.3	426.4																									10	
11	444.3	427.4																										11
12	444.3	428.4	415.6																									12
13	444.3	429.7	416.7																									13
14	444.3	431.1	417.7	361.1																								14
15	444.3	433	418.8	404.9																								15
16	444.3	434.7	419.7	400.5	194.4																							16
17	444.3	436.6	420.6	396	190.6																							17
18	444.3	438.3	421	392.2	186.5	365.8																						18
19	443	440.1	421.2	387.7	181.7	362.2																						19
20	440.2	436.8	421.4	384	177.6	356.9																						20
22	409.5	408.6	396	370.4	168.9	347.3	274.9																					22
24	379.8	379.3	368.9	359.1	161.1	336.6	266.5	116.5	166.4																			24
26	353	354.8	348.3	337.1	153.9	324.9	257.9	112.8	228.2	100.2																		26
28	329.4	331.6	327	316	146.8	307.1	248.3	109.2	221.7	97.4	154.6																	28
30	308.6	311.7	308	299.7	139	289.4	240.2	105.5	214.3	94.6	149.6	85																30
32	289.9	293	290.9	283.3	132.1	272.1	232.3	102.1	207.8	91.5	145.3	83.3	126.9															32
34	272.5	276	273.7	266.8	127.1	256.6	226	99.1	200.6	88.7	140.3	81.4	123.7	75.2														34
36	256.2	259.5	258.7	251.8	122	242.7	219.1	95.9	194.5	86	136	79.3	120.5	73.7	103													36
38	241.2	244.8	244.7	240	117.4	230.1	212.2	93.1	188.2	83.6	132.5	77.4	117.5	72.3	100.5	69												38
40	227	230.8	231.2	227.4	112.4	218	206	90.3	182.7	81.3	129.7	75.2	114.8	70.8	98.5	67.7	84.6											40
45	196.3	200.2	202.2	199.8	101.3	192.8	189.3	83	167.9	76.1	122.9	71	108	67.4	92.7	64.9	80.4	61	57.4	69.4	57							45
50		175.9	177.7	176.9	93.2	171.3	170.2	77.7	153.4	70.7	115.8	67.3	102.6	64	87.2	62	76.2	58.5	55	66.8	55.3	51	56.4	49.7				50
55		156.2	158	157.5	85.6	156.6	152.4	72.7	143.2	66.3	109.4	63.4	97	60.8	82.5	59.4	72.1	56.3	52.8	63.8	53.4	49.2	54.7	48.5	45.4	43.6		55
60		141.5	141.5	141.2	78	142.9	137.7	67.6	132.1	62.3	104.3	59.8	91.4	57.7	78.6	56.7	68.6	54	50.7	61.2	51.6	47.6	53.1	47.1	44	42.2		60
65		128.3	127.9	127.3	72.4	129.9	125.3	63.2	119.6	58.2	99.5	56.9	86.7	54.6	74.8	54.1	65.2	51.9	48.7	58.5	49.8	45.9	51.5	45.9	42.7	40.7		65
70		116.3	115.6	115.6	67.5	118.6	114.5	59.6	109.5	54.4	94.8	54	82.8	51.9	70.9	51.6	62.5	50.1	46.6	56	48.2	44.4	49.6	44.5	41.3	39.4		70
75		105.8	106.6	106.8	62.8	108.2	104.8	56.1	100.1	51.2	90.3	51.1	78.8	49.7	67.8	49.2	59.6	48	44.7	53.2	46.6	42.8	47.7	43.1	40	37.9		75
80		96.7	99.9	99.8	58.8	98.8	96.4	52.4	91.6	48.2	86.6	48.1	74.7	47.3	64.8	47.3	57.1	46	42.7	50.7	44.9	41.1	45.6	41.8	38.7	36.5		80
85		91.8	91.8	90.8	55.5	90.8	88.9	48.8	84.4	45.3	83.2	45.8	71.1	44.9	61.9	45.5	55	44.4	40.8	48.1	43.3	39.7	43.5	40.5	37.5	35.1		85
90		84.7	84.7	83.5	52.2	83.5	81.6	46.5	78.1	42.4	78.9	43.6	68	42.8	59	43.5	52.8	42.7	39.2	46	41.9	38.2	41.6	39.2	36.2	33.7		90
95		78.6	78.6	77.1	49.5	77.1	75.4	44.2	72.4	39.5	73.6	41.5	65.3	40.8	56.3	41.7	50.6	41.3	37.5	44.3	40.5	36.8	39.8	37.7	35	32.3		95
100		72.7	72.7	71.6	47	71.6	69.7	41.9	69.3	37.4	68.6	39.3	62.5	39	54.1	39.9	48.5	39.8	35.9	42.7	39.3	35.5	38	36.4	33.8	31		100
105		66.4	66.4	66.4	46.4	66.4	64.3	39.6	66.4	35.5	64	37.2	59.8	37.3	52	38.3	46.4	38.2	34.3	41	38.1	34.2	36.4	35	32.6	29.8		105
110		61.6	61.6	61.6	45.3	61.6	59.3	37.7	62.2	33.6	59.5	35.2	57.1	35.5	49.9	36.8	44.8	36.7	32.8	39.3	36.8	32.8	34.8	33.6	31.4	28.7		110
115		57.4	57.4	57.4	44.2	57.4	56.1	36.2	57.7	31.8	54.9	33.6	53.7	33.8	47.9	35.4	43.2	35.4	31.3	37.8	35.5	31.6	33	32.2	30.2	27.5		115
120		53.9	53.9	53.9	43.1	53.9	53.8	34.6	53.8	29.9	50.9	32.1	49.9	32.1	45.8	34	41.6	34.2	30.1	36.5	34.3	30.2	31.5	30.7	29	26.3		120
125		52.2	52.2	52.2	42.2	52.2	52.2	33	50.1	28.5	47.2	30.6	46.2	30.6	43.8	32.5	39.9	32.8	28.8	35.4	33.2	29.2	30	29.3	27.9	25.2		125
130		49.2	49.2	49.2	41.2	49.2	49.2	31.8	46.8	27.2	44	29.1	42.8	29.3	41.9	31	38.4	31.6	27.6	34.1	32.2	28.1	28.7	28	26.8	24		130
135		47.6	47.6	47.6	40.2	47.6	47.6	30.6	43.8	25.8	41.5	27.7	39.7	28.1	39.8	29.7	36.8	30.3	26.3	32.9	31	27.1	27.4	26.8	25.7	23		135
140		46.1	46.1	46.1	39.2	46.1	46.1	30	41	24.5	39.9	26.6	36.9	26.8	37	28.7	35.4	29	25.1	31.7	29.9	26	26.2	25.7	24.6	22		140
145		44.6	44.6	44.6	38.7	44.6	44.6	30	38.6	23.5	37.9	25.5	34.4	25.6	34.4	27.6	34	27.7	23.8	30.5	28.9	25	24.9	24.5	23.5	21.1		145
150		43.1	43.1	43.1	38.2	43.1	43.1	30	36.3	22.5	35.6	24.5	32.7	24.4	32	26.6	32.8	26.6	22.7	29.3	27.8	24	23.7	23.5	22.5	20.2		150
155		41.6	41.6	41.6	37.7	41.6	41.6	30	33.4	21.6	33.4	23.4	31.5	23.4	29.7	25.6	31	25.6	21.6	28.2	26.7	22.9	22.4	22.3	21.4	19.4		155
160		40.1	40.1	40.1	37.2	40.1	40.1	30	31.4	22.4	30.3	22.5	27.7	24.5	27.7	24.5	29.1	24.6	20.6	27.1	25.7	22	21.2	21.2	20.4	18.5		160
165		38.6	38.6	38.6	36.7	38.6	38.6	30	29.6	21.7	29.1	21.6	26.6	23.5	27.1	23.5	27.1	23.5	19.6	26.2	24.8	21.1	20.1	20.2	19.3	17.6		165
170		37.1	37.1	37.1	36.2	37.1	37.1	30	27.1	21	27.1	20.7	25.5	22.7	25.3	22.5	27.6	24.6	20.6	25.1	23.9	20.2	19	19.1	18.3	16.7		170
175		35.6	35.6	35.6	35.3	35.6	35.6	30	25.6	20.4	25.6	20.4	24.4	22	23.6	21.5	27.6	24.6	20.6	24	23	19.4	18	18.1	17.4	15.8		175
180		34.1	34.1	34.1	34.8	34.1	34.1	30	24.1	19.8	24.1	19.8	23.1	20.5	22.2	20.5	26.6	23.5	19.6	22.4	22.2	18.6	17.1	17.2	16.4	15		180
185		32.6	32.6	32.6	34.3	32.6	32.6	30	22.6	19.2	22.6	19.2	21.6	18.3	22	20.5	25.6	23.5	19.6	21.2	21.7	17.7	16.1	16.3	15.6	14.3		185
190		31.1	31.1	31.1	33.8	31.1	31.1	30	21.1	18.6	21.1	18.6	20.6	17.2	20.4	19	24.6	22.5	19.6	20.9	21.2	17.7	16.1	16.3	15.6	14.3		190
195		29.6	29.6	29.6	33.3	29.6	29.6	30	19.6	18	19.6	18	19.6	16.2	20.4	19	23.6	21.5	19.6	20.9	21.2	17.7	16.1	16.3	15.6	14.3		195
200		28.1	28.1	28.1	32.8	28.1	28.1	30	18.1	17.4	18.1	17.4	18.1	15.4	20.4	18.5	22.6	20.5	19.6	20.9	21.2	17.7	16.1	16.3	15.6	14.3		200
205		26.6	26.6	26.6	32.3	26.6	26.6	30	16.6	16.8	16.6	16.8	16.6	14.6	20.4	17.9	21.6	19.5	19.6	20.9	21.2	17.7	16.1	16.3	15.6	14.3		205
210		25.1	25.1	25.1																								

Lifting capacities

Forces de levage

T

53 - 279 ft
360°
119,000 lb
16 ft 5 in
19 ft 8 in
23 ft
85%

	53 ft	70 ft	87 ft	105 ft	108 ft	122 ft	139 ft	145 ft	157 ft	163 ft	174 ft	183 ft	191 ft	201 ft	209 ft	218 ft	226 ft	235 ft	241 ft	243 ft	253 ft	259 ft	261 ft	270 ft	276 ft	279 ft			
10	444.3	426.4																									10		
11	444.3	427.4																										11	
12	444.3	428.4	415.6																									12	
13	444.3	429.7	416.7																									13	
14	444.3	431.1	417.7	361.1																								14	
15	444.3	433	418.8	404.9																								15	
16	444.3	434.7	419.7	400.5	194.4																							16	
17	444.3	436.6	420.6	396	190.6																							17	
18	434.7	429.1	410.8	391.2	186.5	365.8																						18	
19	416.8	413	396.6	378.3	181.7	361.4																						19	
20	398.5	395.2	381.7	363.4	177.6	350.9																						20	
22	366.7	364.9	353.9	339.8	168.9	324.8	274.9																					22	
24	334.3	336.7	325.1	313.5	161.1	297.8	266.5	116.5	166.4																			24	
26	306.2	309.7	300.6	290.1	153.9	274.5	257.9	112.8	228.2	100.2																		26	
28	280.8	285.3	278.2	267.7	146.8	255.3	244.9	109.2	221.6	97.4	154.6																	28	
30	258.1	262.4	257.7	248.8	139	239.8	229.7	105.5	213.6	94.6	149.6	85																30	
32	238.2	242.3	239.8	230.6	132.1	224.9	213.3	102.1	199.5	91.5	145.3	83.3	126.9															32	
34	220.1	224.6	222.7	214.7	127.1	210.1	197.9	99.1	183.1	88.7	140.3	81.4	123.7	75.2														34	
36	204.3	208.5	208.3	204.5	122	193.9	182.3	95.9	170.1	86	136	79.3	120.5	73.7	103													36	
38	189.1	193.8	194	191.4	117.4	179.6	168.6	93.1	157.4	83.6	132.5	77.4	117.5	72.3	100.5	69												38	
40	175.5	182	181.3	177.7	112.4	167.1	157.8	90.3	147.6	81.3	129.7	75.2	114.8	70.8	98.5	67.7	84.6											40	
45	144.8	153.2	155.9	149.6	101.3	142.1	133.5	83	125.2	76.1	122.9	71	108	67.4	92.7	64.9	80.4	61	57.4	69.4	57							45	
50		126.4	130.8	128.1	93.2	121.9	115.2	77.7	113.7	70.7	107.1	67.3	102.4	64	87.2	62	76.2	58.5	55	66.8	55.3	51	56.4	49.7				50	
55		106.3	110.5	111.2	85.6	106	104.9	72.7	101.1	66.3	94.8	63.4	89.4	60.8	82.4	59.4	72.1	56.3	52.8	63.8	53.4	49.2	54.7	48.5	45.4	43.6		55	
60		90.8	94.5	95.6	78	93.3	94.6	67.6	89.2	62.3	85.9	59.8	80	57.7	75.9	56.7	68.1	54	50.7	61.2	51.6	47.6	53.1	47.1	44	42.2		60	
65		78.6	82.2	82.9	72.4	84.8	84.5	63.2	79.3	58.2	76.4	56.9	71.7	54.6	67.5	54.1	64.8	51.9	48.7	58.4	49.8	45.9	51.5	45.9	42.7	40.7		65	
70			72.7	72.9	67.5	76.6	75.6	59.6	72	54.4	68.6	54	66.9	51.9	62.9	51.6	59.1	50.1	46.6	53.9	48.2	44.4	49.6	44.5	41.3	39.4		70	
75			64.2	64.6	62.8	68.1	67	56.1	64.9	51.2	62.7	51.1	61.6	49.7	57	49.2	53.1	48	44.7	50.5	46.6	42.8	46.3	43.1	40	37.9		75	
80			57.2	60.4	58.8	60.8	59.9	52.4	60.3	48.2	58.1	48.1	55.5	47.3	52.3	47.3	49.5	46	42.7	46	44.5	41.1	41.6	41.3	38.7	36.5		80	
85				54.4	55	54.7	53.7	48.8	55.1	45.3	53.2	45.8	50.6	44.9	49	45.5	45.3	43.7	40.8	41.6	41.2	39.6	37.3	37.5	36.4	35.1		85	
90				49.2	49.8	49.4	50.2	46.5	49.9	42.4	48.3	43.6	46.7	42.8	44.9	43.2	41.3	40.7	39.2	38	37.5	37	34	34.1	33.1	32.4		90	
95				44.7	45.3	44.7	46.4	44.2	45.2	39.5	44.9	41.5	43.2	40.8	40.9	40.6	37.7	37.2	36.1	34.5	33.9	33.7	30.7	30.8	30	29.3		95	
100				41	41.3	40.7	42.2	41.9	41.1	37.4	41.4	39.3	39.6	39	37.6	37.3	34.4	34.2	33.1	31.3	31	30.8	27.7	27.9	27.3	26.6		100	
105						37.2	38.6	39.1	37.5	35.5	37.7	37.2	36.2	36.5	34.5	34.3	31.3	31.2	30.2	28.5	28.3	28	25	25.2	24.7	24		105	
110						34.4	35.3	35.8	34.3	33.6	34.5	34.7	33	33.6	31.5	31.4	28.7	28.4	27.8	25.8	25.7	25.4	22.6	22.9	22.2	21.7		110	
115						31.7	32.4	32.9	31.6	31.8	31.4	31.9	30.1	30.8	29.1	28.9	26.2	26.1	25.3	23.4	23.4	23.2	20.1	20.7	20.1	19.6		115	
120							29.9	30.3	29	29.6	28.8	29.2	27.5	28.2	26.6	26.6	23.9	23.9	23	21.2	21.2	21	18.2	18.6	18	17.5		120	
125							27.5	27.9	26.6	27.2	26.4	26.8	25.1	25.7	24.3	24.6	21.7	21.7	21.1	19.4	19.3	19.2	16.2	16.7	16.3	15.8		125	
130							25.4	25.8	24.5	25	24.2	24.6	22.8	23.5	22	22.4	19.9	20	19.2	17.5	17.5	17.4	14.5	15	14.5	14		130	
135								23.9	22.5	23	22.2	22.6	20.8	21.5	20	20.4	18.1	18.2	17.5	15.7	15.8	15.8	12.8	13.4	12.9	12.4		135	
140								22.2	20.7	21.2	20.4	20.8	19	19.6	18.2	18.6	16.4	16.5	15.9	14.2	14.2	14.1	11.3	11.9	11.4	10.9		140	
145								19.1	19.6	18.8	19.1	17.3	17.9	16.5	16.9	14.7	15.1	14.4	12.7	12.9	12.7	9.8	10.4	10	9.6			145	
150								17.7	18.1	17.2	17.6	15.7	16.3	14.9	15.4	13.1	13.5	13	11.3	11.4	11.3	8.5	9.2	8.7	8.3			150	
155								16.7	16.8	16.1	14.3	14.9	13.5	13.9	11.6	11.9	11.5	10.1	10.2	10.1	7.2	7.9	7.5	7.1				155	
160									14.5	14.8	13	13.6	12.1	12.5	10.3	10.7	10.4	8.8	9	8.9	6	6.7	6.4	5.9				160	
165									13.4	13.6	11.8	12.3	10.9	11.2	9	9.5	9.2	7.5	7.9	7.9	4.8	5.7	5.3	4.8				165	
170										12.5	10.6	11.2	9.7	10.1	7.9	8.3	8	6.3	6.8	6.8	3.5	4.5	4.2	3.5				170	
175										11.5	9.6	10.1	8.6	9	6.8	7.2	6.9	5.3	5.7	5.8									175
180												8.7	9.1	7.6	8	5.8	6.2	5.8	4.2	4.7	4.8								180
185												7.8	8.2	6.7	7.1	4.9	5.3	4.9	3.6	3.8									185
190													7.3	5.8	6.2	3.9	4.3	4											190
195													6.6	5	5.3														195
200															4.3	4.6													200
205																3.9													205

Lifting heights

Hauteurs de levage

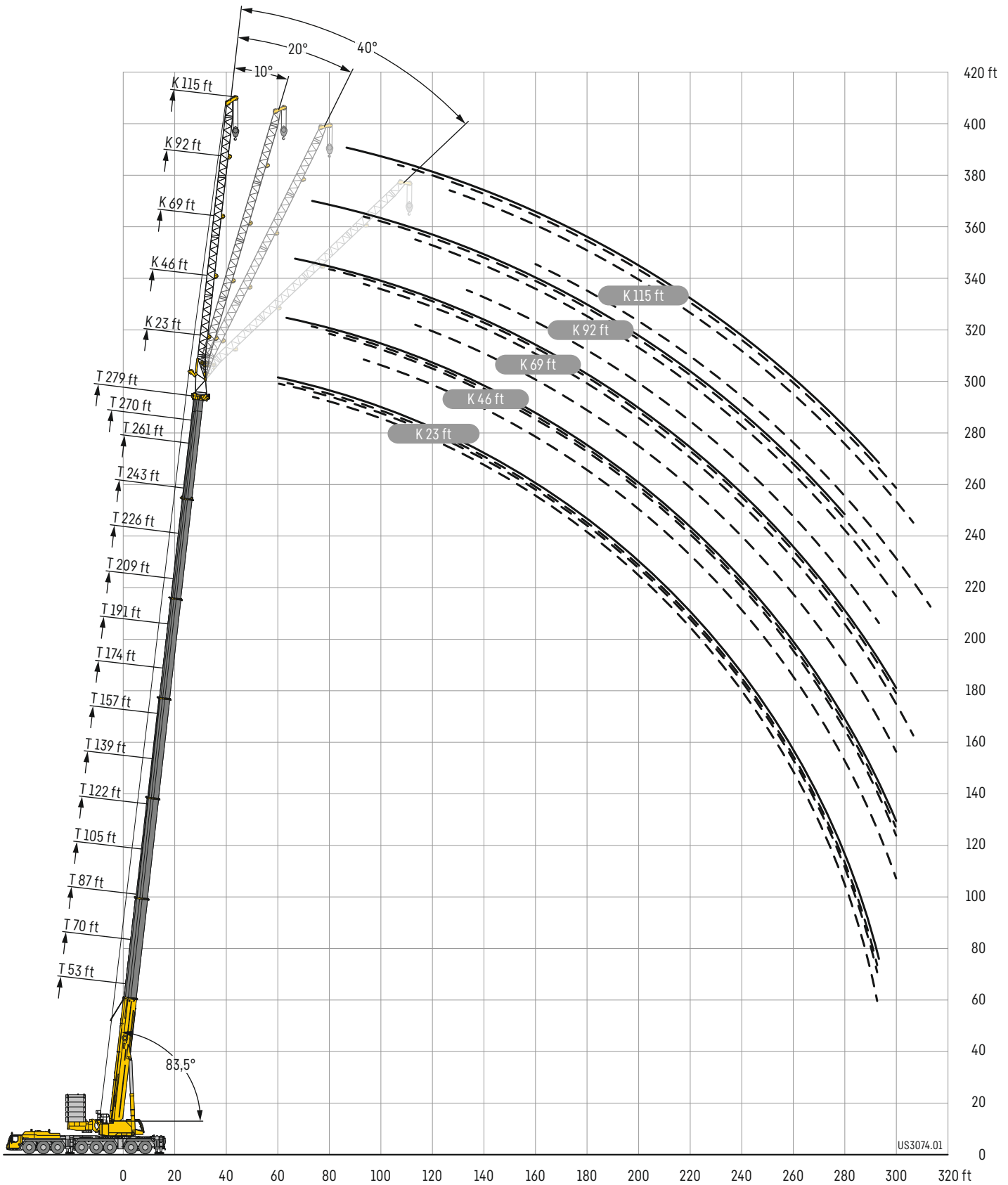

Lifting capacities

Forces de levage

TK 23

	218 ft				226 ft				235 ft				241 ft				243 ft				253 ft				259 ft					
	0°	10°	20°	40°	0°	10°	20°	40°	0°	10°	20°	40°	0°	10°	20°	40°	0°	10°	20°	40°	0°	10°	20°	40°	0°	10°	20°	40°		
45		50.3			55.5																									45
50	49	48.4	48		55.5	55			45.6	45			43.8				51.2													50
55	47.2	46.6	46.2	46	55.5	54.1	49.3	44.6	44.1	43.8			42.6	42.4	42.3		51.1	50.6	49.2					41.8	41.4					55
60	45.4	44.9	44.5	44.3	55.1	55.3	53.2	48.5	43.1	42.6	42.3	42.2	41.1	40.9	40.9	41	49.9	49.7	48.5	45.5	40.9	40.6	40.3	40.1	38.8	38.6	38.6			60
65	43.7	43.2	42.9	42.7	53.5	54.4	52.2	47.8	41.6	41.2	41	40.8	39.6	39.5	39.5	39.7	48.4	48.4	47.8	45	39.7	39.4	39.2	39.1	37.6	37.4	37.4	37.7		65
70	42.1	41.6	41.3	41.2	51.4	52	51.2	47	40.3	39.9	39.6	39.5	38.3	38.1	38.1	38.3	46.7	47	46.8	44.4	38.5	38.3	38	37.9	36.4	36.3	36.3	36.5		70
75	40.6	40.1	39.9	39.7	49.1	49.5	49.9	46.3	39	38.6	38.4	38.2	36.9	36.8	36.8	37	44.8	45.2	45.5	43.9	37.3	37.1	36.9	36.9	35.3	35.1	35.1	35.4		75
80	39.1	38.7	38.5	38.3	47.1	47.2	47.7	45.7	37.7	37.4	37.2	37	35.6	35.5	35.5	35.7	43	43.4	43.8	43.3	36.2	36	35.9	35.8	34.2	34	34	34.2		80
85	37.8	37.4	37.1	37	45.4	45.3	45.4	45.1	36.5	36.2	36	35.9	34.4	34.3	34.2	34.5	41.1	41.5	42	42.5	35.2	35	34.9	34.8	33.1	33	33	33.2		85
90	36.5	36.2	35.9	35.8	43.8	43.7	43.7	43.8	35.3	35.1	34.9	34.8	33.2	33.1	33.1	33.3	39.3	39.7	40.1	41.1	34.1	33.9	33.9	33.9	32	31.9	31.9	32.1		90
95	35.1	34.9	34.8	34.6	42.2	42.1	42.2	42.3	34.2	34	33.9	33.8	32	32	31.9	32.2	37.6	38	38.4	39.2	33.1	32.9	32.9	32.9	30.9	30.9	31	31.1		95
100	33.8	33.7	33.6	33.5	40.6	40.6	40.7	40.9	33.1	32.9	32.8	32.8	30.8	30.8	30.8	31.1	36	36.3	36.8	37.5	32.2	32	31.9	32	29.9	29.9	30	30.2		100
105	32.5	32.4	32.4	32.3	39.1	39.1	39.2	39.4	32	31.9	31.8	31.8	29.7	29.7	29.7	30	34.6	34.8	35.1	35.8	31.2	31.1	31	31.1	28.9	28.9	29	29.3		105
110	31.2	31.2	31.2	31.1	37.5	37.5	37.7	38	30.9	30.8	30.8	30.8	28.5	28.6	28.7	28.9	33.5	33.4	33.6	34.2	30.3	30.2	30.1	30.2	27.9	28	28.1	28.3		110
115	30.1	30.1	30.1	30	35.9	36	36.2	36.5	29.8	29.8	29.8	29.9	27.4	27.5	27.6	27.8	32.4	32.4	32.4	32.7	29.4	29.4	29.3	29.4	27	27.1	27.1	27.4		115
120	29	29	29	28.9	34.7	34.7	34.7	35.1	28.7	28.7	28.7	28.9	26.2	26.4	26.5	26.8	31.3	31.3	31.4	31.6	28.5	28.5	28.4	28.6	26	26.1	26.2	26.5		120
125	27.9	27.9	27.9	27.8	33.6	33.5	33.6	33.7	27.8	27.8	27.7	27.9	25.1	25.2	25.4	25.7	30.3	30.3	30.3	30.6	27.6	27.6	27.6	27.7	25	25.2	25.3	25.6		125
130	26.8	26.8	26.8	26.8	32.4	32.3	32.4	32.6	26.9	26.8	26.8	27	24.1	24.3	24.4	24.7	29.3	29.3	29.3	29.6	26.7	26.7	26.7	26.9	24.1	24.2	24.3	24.7		130
135	25.7	25.7	25.8	25.8	31.2	31.2	31.3	31.4	26	25.9	26	26.1	23.2	23.3	23.4	23.7	28.3	28.3	28.4	28.7	25.9	25.9	25.9	26.1	23.2	23.3	23.4	23.8		135
140	24.6	24.7	24.7	24.8	30.1	30	30.1	30.3	25.1	25	25.1	25.2	22.2	22.3	22.4	22.7	27.4	27.4	27.5	27.7	25.1	25.1	25.1	25.3	22.4	22.5	22.6	22.9		140
145	23.5	23.6	23.6	23.7	28.9	28.9	29	29.2	24.2	24.2	24.2	24.3	21.2	21.4	21.5	21.7	26.5	26.5	26.6	26.8	24.3	24.4	24.3	24.5	21.5	21.6	21.7	22		145
150	22.6	22.6	22.5	22.7	27.7	27.8	27.9	28	23.3	23.3	23.3	23.4	20.2	20.4	20.5	20.8	25.5	25.6	25.6	25.9	23.6	23.6	23.6	23.7	20.7	20.8	20.9	21.2		150
155	21.7	21.7	21.7	21.8	26.6	26.7	26.7	26.9	22.4	22.4	22.4	22.5	19.3	19.4	19.6	19.8	24.6	24.6	24.7	24.9	22.8	22.9	22.9	23	19.9	20	20.1	20.4		155
160	21	20.9	20.9	21	25.6	25.6	25.7	25.8	21.5	21.5	21.5	21.7	18.3	18.5	18.6	18.8	23.7	23.7	23.8	24	22.1	22.1	22.1	22.3	19.1	19.2	19.3	19.6		160
165	20.2	20.2	20.2	20.2	24.6	24.7	24.7	24.8	20.6	20.7	20.7	20.8	17.4	17.5	17.7	17.9	22.7	22.8	22.9	23.1	21.3	21.4	21.4	21.5	18.3	18.4	18.5	18.7		165
170	19.4	19.4	19.4	19.5	23.7	23.7	23.8	23.9	19.8	19.9	19.9	20	16.6	16.7	16.8	17	21.9	21.9	22	22.2	20.5	20.6	20.6	20.8	17.5	17.6	17.7	17.9		170
175	18.6	18.6	18.6	18.7	22.7	22.8	22.9	23	19.1	19.1	19.1	19.2	15.8	15.9	16	16.1	21.1	21.1	21.2	21.3	19.8	19.9	19.9	20	16.7	16.8	16.9	17.1		175
180	17.8	17.8	17.9	18	21.8	21.9	21.9	22.1	18.3	18.3	18.4	18.5	15	15.1	15.2	15.3	20.3	20.4	20.4	20.5	19.1	19.2	19.1	19.3	16	16	16.1	16.3		180
185	17.1	17.1	17.1	17.2	20.8	20.9	21	21.1	17.5	17.5	17.6	17.7	14.2	14.3	14.4	14.6	19.6	19.6	19.7	19.8	18.4	18.5	18.5	18.6	15.3	15.3	15.4	15.5		185
190	16.6	16.6	16.5	16.6	19.9	20	20.1	20.2	16.7	16.8	16.8	16.9	13.4	13.5	13.6	13.8	18.8	18.9	18.9	19	17.8	17.8	17.8	18	14.6	14.7	14.8	14.9		190
195	16	16	16	16.1	19.2	19.2	19.3	19.4	15.9	16	16.1	16.2	12.6	12.8	12.9	13	18	18.1	18.2	18.3	17.1	17.2	17.2	17.3	14	14	14.1	14.3		195
200	15.4	15.4	15.4	15.5	18.5	18.5	18.6	18.7	15.2	15.3	15.3	15.4	11.9	12	12.1	12.2	17.3	17.4	17.5	17.6	16.4	16.5	16.5	16.6	13.3	13.4	13.5	13.6		200
205	14.9	14.9	14.9	15	17.8	17.8	17.9	18	14.6	14.6	14.7	14.8	11.3	11.4	11.4	11.4	16.5	16.7	16.7	16.8	15.8	15.8	15.9	16	12.7	12.7	12.8	12.9		205
210	14.3	14.3	14.3	14.4	17.1	17.2	17.2	17.3	14	14	14.1	14.1	10.8	10.9	10.9	10.9	15.9	16	16.1	16.2	15.1	15.2	15.2	15.3	12	12.1	12.2	12.3		210
215	13.8	13.8	13.8	13.9	16.4	16.5	16.5	16.6	13.4	13.4	13.5	13.5	10.3	10.4	10.4	10.4	15.4	15.4	15.5	15.6	14.5	14.5	14.6	14.7	11.4	11.4	11.6	11.6		215
220	13.4	13.4	13.4	13.5	15.7	15.8	15.8	15.9	12.7	12.8	12.9	12.9	9.8	9.9	9.9	10	14.8	14.9	14.9	15	14	14	14	14.1	10.8	10.9	11	11		220
225	12.9	13	13	13.1	15.2	15.2	15.3	15.3	12.2	12.2	12.3	12.3	9.4	9.4	9.5	9.5	14.2	14.3	14.3	14.4	13.5	13.5	13.5	13.6	10.4	10.5	10.5	10.6		225
230	12.5	12.5	12.5	12.8	14.7	14.8	14.8	14.9	11.6	11.6	11.7	11.7	8.9	8.9	9	9	13.7	13.7	13.8	13.8	13	13	13	13.1	10	10.1	10.1	10.2		230
235	12.1	12.4			14.2	14.3	14.3	14.4	11.2	11.2	11.3	11.3	8.4	8.5	8.5	8.5	13.1	13.2	13.2	13.3	12.4	12.5	12.5	12.6	9.6	9.7	9.7	9.7		235
240					12.8	13.4	13.4	11.6	10.8	10.8	10.9	10.9	8.1	8.1	8.1	8.1	12.6	12.7	12.7	12.8	11.9	12	12	12.1	9.2	9.3	9.3	9.3		240
245									10.4	10.5	10.5	10.5	7.7	7.8	7.8	7.8	12.3	12.3	12.3	12.4	11.4	11.5	11.5	11.6	8.8	8.9	8.9	8.9		245
250									10.2	10.2	10.2		7.4	7.4	7.4	7.4	11.9	11.9	12	12	11.1	11.1	11.1	11.2	8.5	8.5	8.5	8.5		250
255													7.1	7.1	7.1	7.2	11.5	11.5	11.6	11.6	10.8	10.8	10.8	10.9	8.2	8.2	8.2	8.2		255
260																	7	7.5	7.1		10.5	10.6	10.5	10.6	7.9	7.9	7.9	7.9		260
265																					10.3	10.3	10.3	9.8	7.6	7.6	7.6	7.6		265
270																					3.8				7.3	7.4	7.4	7.3	</	

Lifting capacities

Forces de levage

TK 23

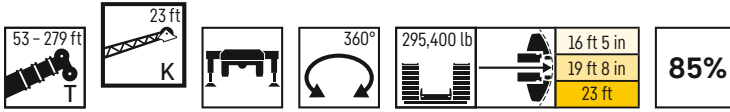

	261 ft				264 ft				270 ft				276 ft				279 ft				
	23 ft																				
	0°	10°	20°	40°	0°	10°	20°	40°	0°	10°	20°	40°	0°	10°	20°	40°	0°	10°	20°	40°	
55		43				41.4															55
60	42.1	41.9	41.8		39.9	40.2	40.6		37.8	37.6	37.6			35.7				35			60
65	41	40.8	40.7	40.8	38.6	38.9	39.3	40	36.8	36.7	36.6			34.8	34.7	34.7		33.8	34	34.1	65
70	39.9	39.7	39.6	39.8	37.3	37.6	37.9	38.8	35.9	35.7	35.7	35.8		33.9	33.8	33.8	34	32.7	33	33.3	70
75	38.9	38.7	38.6	38.8	35.9	36.3	36.6	37.4	35	34.8	34.7	34.9		32.9	32.9	32.9	33.1	31.7	32	32.3	75
80	37.9	37.7	37.6	37.8	34.6	34.9	35.3	36.1	34	33.9	33.8	34		32	31.9	31.9	32.2	30.6	30.9	31.3	80
85	36.9	36.7	36.6	36.8	33.3	33.6	33.9	34.7	33.1	33	32.9	33.1		31.1	31	31.1	31.3	29.6	29.8	30.2	85
90	35.9	35.7	35.6	35.8	32	32.3	32.6	33.4	32.3	32.1	32.1	32.2		30.1	30.2	30.2	30.4	28.5	28.8	29.1	90
95	34.7	34.7	34.7	34.8	30.7	31	31.4	32.1	31.4	31.3	31.2	31.4		29.2	29.2	29.3	29.6	27.5	27.7	28	95
100	33.3	33.6	33.7	33.9	29.6	29.8	30.1	30.8	30.6	30.4	30.4	30.6		28.3	28.3	28.4	28.8	26.4	26.7	27	100
105	32	32.2	32.5	33	28.4	28.6	28.9	29.5	29.8	29.6	29.7	29.8		27.4	27.4	27.5	27.9	25.4	25.6	25.9	105
110	30.7	31	31.3	31.9	27.3	27.5	27.7	28.4	28.8	28.9	28.9	29		26.5	26.6	26.7	27	24.4	24.7	24.9	110
115	29.4	29.7	30	30.7	26.2	26.4	26.7	27.2	27.8	27.8	28	28.3		25.6	25.7	25.8	26.1	23.5	23.7	23.9	115
120	28.2	28.5	28.8	29.4	25.1	25.3	25.6	26.1	26.7	26.8	27	27.3		24.8	24.9	25	25.3	22.6	22.8	23	120
125	26.9	27.3	27.6	28.2	24	24.3	24.5	25	25.6	25.8	26	26.3		23.9	24	24.2	24.5	21.7	21.9	22.1	125
130	25.7	26	26.3	26.9	22.9	23.2	23.4	23.9	24.6	24.8	25	25.4		23	23.2	23.3	23.6	20.7	21	21.2	130
135	24.5	24.8	25.1	25.7	21.9	22.1	22.4	22.9	23.5	23.8	24	24.4		22.2	22.3	22.5	22.8	19.8	20.1	20.3	135
140	23.4	23.7	23.9	24.4	20.9	21.1	21.4	21.8	22.5	22.8	23	23.4		21.3	21.5	21.7	22	18.9	19.2	19.4	140
145	22.4	22.6	22.8	23.3	20	20.2	20.4	20.8	21.5	21.8	22	22.4		20.5	20.6	20.9	21.2	18	18.3	18.5	145
150	21.4	21.6	21.9	22.2	19.2	19.4	19.6	19.9	20.6	20.9	21	21.4		19.6	19.8	20.1	20.4	17.2	17.4	17.7	150
155	20.4	20.7	20.9	21.2	18.3	18.5	18.7	19	19.7	20	20.1	20.5		18.8	19	19.2	19.6	16.5	16.7	16.9	155
160	19.5	19.7	19.9	20.3	17.5	17.7	17.9	18.2	18.8	19.1	19.3	19.6		18	18.1	18.4	18.7	15.8	15.9	16.1	160
165	18.5	18.7	18.9	19.3	16.6	16.8	17	17.3	17.9	18.2	18.4	18.7		17.1	17.3	17.6	17.9	15	15.2	15.4	165
170	17.5	17.7	18	18.3	15.8	16	16.2	16.5	17	17.3	17.5	17.8		16.3	16.5	16.7	17	14.3	14.5	14.7	170
175	16.5	16.7	17	17.3	14.9	15.1	15.4	15.6	16.1	16.4	16.6	16.9		15.4	15.6	15.9	16.2	13.6	13.8	14	175
180	15.5	15.8	16	16.3	14.1	14.3	14.5	14.8	15.3	15.5	15.7	16		14.6	14.8	15	15.3	12.9	13.1	13.2	180
185	14.8	14.9	15.1	15.4	13.4	13.5	13.7	13.9	14.4	14.6	14.8	15.1		13.8	14	14.2	14.5	12.1	12.4	12.5	185
190	14.1	14.2	14.4	14.6	12.8	12.9	13	13.2	13.6	13.8	14	14.2		12.9	13.1	13.4	13.6	11.4	11.6	11.8	190
195	13.3	13.4	13.6	13.8	12.1	12.3	12.4	12.6	12.9	13.1	13.3	13.4		12.3	12.4	12.6	12.8	10.8	11	11.1	195
200	12.6	12.7	12.9	13	11.5	11.6	11.7	11.9	12.3	12.5	12.6	12.7		11.6	11.7	11.9	12.1	10.2	10.4	10.5	200
205	11.8	11.9	12.1	12.2	10.9	11	11.1	11.3	11.6	11.8	11.9	12		10.9	11.1	11.2	11.4	9.7	9.8	9.9	205
210	11	11.2	11.4	11.5	10.2	10.3	10.5	10.6	10.9	11.1	11.2	11.4		10.3	10.5	10.6	10.8	9.1	9.3	9.3	210
215	10.3	10.5	10.6	10.7	9.6	9.7	9.8	10	10.2	10.4	10.5	10.7		9.7	9.8	9.9	10.1	8.6	8.7	8.8	215
220	9.6	9.8	9.9	10	9	9.1	9.2	9.3	9.5	9.7	9.9	10		9	9.2	9.3	9.4	8	8.2	8.2	220
225	9	9.1	9.2	9.3	8.4	8.5	8.6	8.7	8.9	9	9.2	9.3		8.4	8.6	8.7	8.8	7.5	7.6	7.7	225
230	8.5	8.6	8.7	8.7	7.9	8	8	8.1	8.3	8.4	8.5	8.6		7.7	7.9	8	8.1	7	7.1	7.1	230
235	7.9	8	8.1	8.1	7.3	7.4	7.5	7.6	7.7	7.9	8	8		7.2	7.3	7.4	7.5	6.4	6.5	6.6	235
240	7.3	7.5	7.5	7.6	6.8	6.9	7	7	7.2	7.3	7.4	7.5		6.7	6.8	6.9	7	6	6.1	6.1	240
245	6.8	6.9	6.9	7	6.3	6.3	6.4	6.4	6.7	6.8	6.9	6.9		6.2	6.3	6.4	6.4	5.5	5.6	5.6	245
250	6.2	6.3	6.4	6.4	5.7	5.8	5.9	5.9	6.2	6.3	6.4	6.4		5.6	5.8	5.8	5.9	5.1	5.1	5.2	250
255	5.7	5.8	5.8	5.8	5.2	5.3	5.4	5.3	5.7	5.8	5.8	5.8		5.1	5.3	5.3	5.4	4.6	4.7	4.7	255
260	5.3	5.3	5.4	5.3	4.8	4.8	4.9	4.8	5.2	5.2	5.3	5.3		4.6	4.8	4.8	4.8	4.2	4.2	4.3	260
265	4.8	4.9	4.9	4.9	4.3	4.4	4.4	4.3	4.7	4.8	4.8	4.8		4.2	4.3	4.3	4.3	3.7	3.8	3.8	265
270	4.4	4.4	4.4	4.4	3.9	4	4	3.9	4.3	4.3	4.4	4.3		3.7	3.8	3.8	3.8	3.3	3.3	3.4	270
275	4	4	4.1		3.4	3.5	3.5	3.4	3.9	3.9	3.9	3.8		3.3	3.4	3.4	3.4	2.9	2.9	2.9	275
280						2.7			3.5	3.5	3.5	3.4		2.9	3	3	2.9	2.5	2.5	2.5	280
285									3.2	3.2	3.2			2.5	2.6	2.6	2.5	2.1	2.1	2.1	285
290														2.2	2.2	2.3		1.6	1.7	1.6	290

maxt_268_005_00001_00_000

Lifting capacities

Forces de levage

TK 46

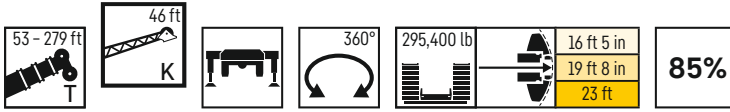

	261 ft				264 ft				270 ft				276 ft				279 ft				
	0°	10°	20°	40°	0°	10°	20°	40°	46 ft				0°	10°	20°	40°	0°	10°	20°	40°	
55	23.9				23.5																55
60	24				23.6				22.5				21.5				21.1				60
65	24.2	24.6			23.8	24.3			22.6	23.3			21.7				21.2				65
70	24.3	24.3	23.1		23.9	24	22.8		22.7	23			21.8	22.3			21.4	21.9			70
75	24.5	24	22.7		24	23.7	22.4		22.9	22.8	21.7		21.9	22	21.1		21.5	21.7	20.8		75
80	24.5	23.7	22.3		24.1	23.4	22.1		23	22.5	21.4		22	21.8	20.9		21.6	21.5	20.6		80
85	24.5	23.4	22	18.3	24.1	23.1	21.8	18.3	23	22.2	21.1	18.1	22.1	21.6	20.6	18.1	21.7	21.2	20.3		85
90	24.4	23	21.7	18.1	24.1	22.8	21.5	18.1	23	21.9	20.8	18	22.1	21.3	20.3	17.9	21.7	21	20.1	17.8	90
95	24.1	22.7	21.4	18	23.8	22.4	21.2	18	22.8	21.6	20.6	17.8	22	21.1	20.1	17.8	21.7	20.8	19.9	17.7	95
100	23.8	22.3	21.1	17.9	23.5	22.1	20.9	17.8	22.6	21.4	20.3	17.7	21.9	20.8	19.9	17.6	21.5	20.5	19.6	17.6	100
105	23.5	22	20.8	17.7	23.2	21.8	20.6	17.7	22.3	21.1	20.1	17.6	21.6	20.6	19.6	17.5	21.3	20.3	19.4	17.5	105
110	23.2	21.7	20.4	17.6	22.8	21.5	20.4	17.6	22.1	20.8	19.8	17.5	21.4	20.3	19.4	17.4	21.1	20.1	19.2	17.3	110
115	22.8	21.4	20.2	17.5	22.4	21.2	20.1	17.5	21.8	20.6	19.6	17.4	21.2	20.1	19.2	17.3	20.6	19.9	19	17.3	115
120	22.5	21.1	19.9	17.4	21.8	20.9	19.8	17.4	21.4	20.3	19.4	17.3	20.9	19.9	19	17.2	20.1	19.7	18.8	17.2	120
125	22.1	20.9	19.7	17.3	21.1	20.4	19.6	17.3	21	20.1	19.2	17.2	20.4	19.7	18.8	17.2	19.4	19.4	18.6	17.2	125
130	21.7	20.6	19.5	17.3	20.4	19.9	19.2	17.2	20.6	19.8	19	17.2	19.9	19.3	18.6	17.1	18.7	19	18.5	17.1	130
135	21.4	20.4	19.3	17.3	19.8	19.4	18.9	17.2	20.2	19.4	18.8	17.1	19.4	18.9	18.3	17.1	18.1	18.4	18.1	17.1	135
140	21	20.1	19.1	17.3	19.1	18.9	18.5	17.1	19.8	19.1	18.5	17.1	18.9	18.5	18	17	17.4	17.8	17.6	17	140
145	20.6	19.9	18.9	17.2	18.4	18.4	18.2	17.1	19.3	18.8	18.3	17.1	18.4	18.1	17.7	16.8	16.7	17.1	17.1	16.7	145
150	20.2	19.6	18.7	17.2	17.8	17.9	17.8	17	18.9	18.5	18.1	17.1	17.8	17.7	17.3	16.7	16.1	16.5	16.5	16.3	150
155	19.5	19.3	18.5	17.2	17.1	17.4	17.5	17	18.5	18.2	17.9	17.1	17.3	17.3	17	16.5	15.4	15.8	16	15.9	155
160	18.8	18.8	18.3	17.2	16.4	16.8	17.1	16.9	17.9	17.9	17.7	17.1	16.8	16.8	16.7	16.3	14.7	15.2	15.4	15.5	160
165	18	18.1	17.8	17	15.8	16.2	16.6	16.8	17.2	17.4	17.4	17.1	16.2	16.4	16.4	16.1	14.1	14.5	14.9	15.1	165
170	17.2	17.4	17.1	16.7	15.1	15.5	15.9	16.5	16.5	16.8	16.9	17.1	15.5	15.8	16	16	13.6	13.9	14.3	14.7	170
175	16.4	16.6	16.5	16.1	14.4	14.8	15.2	15.8	15.8	16.1	16.3	16.8	14.9	15.2	15.5	15.8	13	13.4	13.7	14.3	175
180	15.7	15.9	15.9	15.6	13.7	14.1	14.5	15.1	15.1	15.4	15.7	16.2	14.3	14.6	14.9	15.3	12.4	12.8	13.1	13.8	180
185	14.9	15.2	15.2	15.1	13	13.4	13.8	14.4	14.4	14.7	15	15.5	13.6	14	14.3	14.7	11.8	12.2	12.6	13.2	185
190	14.1	14.5	14.6	14.6	12.4	12.8	13.1	13.7	13.7	14.1	14.3	14.8	13	13.3	13.7	14.1	11.2	11.7	12	12.6	190
195	13.4	13.7	13.9	14	11.7	12.1	12.4	13	13	13.4	13.7	14.1	12.3	12.7	13	13.5	10.7	11.1	11.4	12	195
200	12.7	13	13.3	13.5	11.1	11.4	11.8	12.3	12.3	12.7	13	13.5	11.7	12.1	12.4	12.8	10.1	10.5	10.8	11.4	200
205	12.1	12.4	12.7	12.9	10.5	10.8	11.1	11.5	11.7	12	12.3	12.8	11	11.4	11.8	12.2	9.5	10	10.3	10.8	205
210	11.4	11.7	12	12.4	10.1	10.3	10.5	10.8	11.1	11.4	11.6	12.1	10.4	10.8	11.2	11.6	9	9.4	9.7	10.2	210
215	10.8	11.1	11.4	11.7	9.6	9.8	10	10.3	10.5	10.8	11	11.4	9.9	10.2	10.6	11	8.5	8.9	9.1	9.5	215
220	10.2	10.5	10.8	11.1	9	9.3	9.5	9.8	9.9	10.2	10.5	10.8	9.3	9.7	10	10.4	8	8.3	8.6	8.9	220
225	9.6	9.9	10.2	10.5	8.5	8.8	9	9.3	9.4	9.7	9.9	10.2	8.8	9.1	9.4	9.8	7.6	7.9	8.1	8.4	225
230	9	9.3	9.6	9.8	8	8.3	8.5	8.7	8.8	9.1	9.3	9.6	8.3	8.6	8.9	9.2	7.1	7.4	7.6	7.9	230
235	8.4	8.7	9	9.2	7.5	7.8	8	8.2	8.2	8.5	8.8	9	7.7	8	8.3	8.6	6.7	7	7.2	7.4	235
240	7.8	8.1	8.4	8.5	7	7.3	7.5	7.7	7.7	8	8.2	8.4	7.2	7.5	7.7	8	6.2	6.5	6.7	6.9	240
245	7.3	7.5	7.8	7.9	6.6	6.8	7	7.2	7.1	7.4	7.7	7.8	6.6	6.9	7.2	7.4	5.8	6.1	6.2	6.4	245
250	6.8	7	7.2	7.3	6.2	6.4	6.6	6.7	6.6	6.8	7.1	7.2	6.1	6.4	6.6	6.8	5.3	5.6	5.8	5.9	250
255	6.3	6.5	6.7	6.8	5.7	5.9	6.1	6.2	6.2	6.4	6.6	6.7	5.6	5.9	6.1	6.2	4.9	5.1	5.3	5.4	255
260	5.8	6	6.2	6.2	5.3	5.4	5.6	5.6	5.7	5.9	6.1	6.1	5.2	5.4	5.6	5.7	4.5	4.7	4.8	5	260
265	5.4	5.5	5.7	5.6	4.8	5	5.1	5.1	5.2	5.5	5.6	5.6	4.7	4.9	5.1	5.2	4.1	4.3	4.4	4.5	265
270	4.9	5	5.1	5.1	4.4	4.5	4.6	4.6	4.8	5	5.1	5.1	4.3	4.5	4.6	4.7	3.7	3.9	4	4	270
275	4.4	4.5	4.6	4.5	4	4.1	4.2	4.1	4.3	4.5	4.6	4.6	3.9	4.1	4.2	4.2	3.3	3.5	3.6	3.6	275
280	4	4.1	4.1	4	3.5	3.6	3.7	3.6	3.9	4.1	4.2	4	3.4	3.6	3.7	3.7	2.9	3.1	3.2	3.2	280
285	3.6	3.7	3.7	3.4	3.1	3.2	3.2	3	3.4	3.6	3.7	3.5	3	3.2	3.3	3.2	2.6	2.7	2.8	2.7	285
290	3.2	3.3	3.2	2.9	2.7	2.8	2.8	2.5	3.1	3.2	3.2	3	2.6	2.7	2.8	2.7	2.1	2.3	2.4	2.2	290
295	2.8	2.8	2.8		2.3	2.4	2.4	2.1	2.7	2.8	2.8	2.5	2.2	2.3	2.4	2.2	1.6	1.7	1.9	1.6	295
300					2	2	2		2.3	2.4	2.4	2	1.8	1.9	1.9						300
305									2	2	1.9										305

maxt_268_005_01001_00_000

Lifting capacities

Forces de levage

TK 69

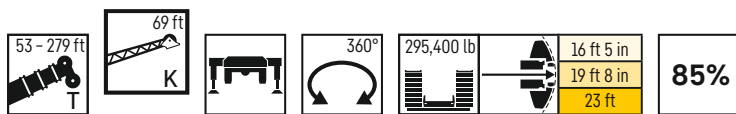

	218 ft				226 ft				235 ft				241 ft				243 ft				253 ft				259 ft						
	69 ft																														
	0°	10°	20°	40°	0°	10°	20°	40°	0°	10°	20°	40°	0°	10°	20°	40°	0°	10°	20°	40°	0°	10°	20°	40°	0°	10°	20°	40°			
50	17.2																												50		
55	17.1				18				16.4					16															55		
60	17				17.9				16.3					15.9				16.7					15.5				15.1		60		
65	16.8	15.4			17.7	16.2			16.1					15.8				16.5					15.4				15		65		
70	16.6	15.1			17.5	15.8			16	14.7				15.6	14.5			16.4	15.1				15.2				14.8		70		
75	16.3	14.8	13.3		17.2	15.5			15.8	14.5				15.4	14.2			16.2	14.8				15.1	14			14.7	13.8	75		
80	16.1	14.5	13		16.9	15.2	13.5		15.5	14.2	12.8			15.2	14	12.7		16	14.5				14.9	13.8			14.6	13.5	80		
85	15.8	14.2	12.8		16.6	14.8	13.2		15.3	13.9	12.6			15	13.7	12.5		15.7	14.3	12.8			14.7	13.6	12.4		14.4	13.3	12.2	85	
90	15.5	13.9	12.5	10.4	16.3	14.6	13		15.1	13.7	12.4			14.8	13.5	12.3		15.5	14	12.6			14.5	13.3	12.1		14.2	13.1	12	90	
95	15.2	13.6	12.3	10.3	16	14.2	12.7	10.5	14.8	13.4	12.2	10.3		14.6	13.3	12.1		15.2	13.7	12.4			14.3	13.1	12		14	12.9	11.8	95	
100	14.9	13.4	12.1	10.2	15.7	13.9	12.5	10.3	14.6	13.2	12	10.2	14.3	13	11.9	10.1	15	13.5	12.2	10.3			14.1	12.9	11.8	10.1	13.8	12.7	11.7	100	
105	14.6	13.1	11.9	10.1	15.4	13.7	12.3	10.2	14.3	13	11.8	10.1	14.1	12.8	11.7	10	14.7	13.3	12	10.2			13.9	12.7	11.6	10	13.6	12.5	11.5	10	105
110	14.4	12.9	11.7	10	15.1	13.4	12.1	10.2	14.1	12.7	11.6	10	13.9	12.6	11.5	9.9	14.5	13	11.8	10.1			13.7	12.5	11.5	9.9	13.4	12.3	11.3	9.9	110
115	14.1	12.7	11.5	10	14.8	13.2	11.9	10.1	13.8	12.5	11.4	9.9	13.7	12.4	11.3	9.9	14.2	12.8	11.6	10			13.5	12.3	11.3	9.9	13.2	12.1	11.2	9.8	115
120	13.8	12.5	11.3	9.9	14.5	13	11.7	10	13.6	12.3	11.2	9.8	13.4	12.2	11.2	9.8	14	12.6	11.4	9.9			13.3	12.1	11.2	9.8	13.1	11.9	11.1	9.7	120
125	13.5	12.3	11.2	9.8	14.2	12.8	11.6	9.9	13.4	12.2	11.1	9.8	13.2	12	11	9.7	13.7	12.4	11.3	9.8			13.1	12	11	9.7	12.9	11.8	10.9	9.7	125
130	13.3	12.1	11	9.8	13.9	12.5	11.4	9.9	13.1	12	11	9.7	13	11.9	10.9	9.7	13.5	12.2	11.2	9.8			12.9	11.8	10.9	9.7	12.7	11.7	10.8	9.6	130
135	13	11.9	10.9	9.7	13.6	12.3	11.2	9.8	12.9	11.8	10.9	9.7	12.8	11.7	10.8	9.7	13.2	12	11	9.7			12.7	11.7	10.8	9.6	12.5	11.5	10.7	9.6	135
140	12.8	11.7	10.8	9.7	13.4	12.1	11.1	9.8	12.6	11.6	10.7	9.6	12.6	11.5	10.7	9.6	13	11.9	10.9	9.7			12.5	11.5	10.7	9.6	12.3	11.4	10.6	9.6	140
145	12.5	11.5	10.6	9.7	13.1	11.8	10.9	9.7	12.4	11.4	10.6	9.6	12.3	11.4	10.6	9.6	12.8	11.7	10.8	9.6			12.3	11.4	10.6	9.5	12.1	11.3	10.5	9.5	145
150	12.3	11.4	10.5	9.6	12.9	11.7	10.7	9.7	12.3	11.3	10.5	9.6	12.1	11.2	10.5	9.6	12.6	11.5	10.7	9.6			12.1	11.2	10.5	9.5	11.9	11.2	10.4	9.5	150
155	12.1	11.2	10.4	9.6	12.7	11.5	10.6	9.6	12.1	11.1	10.4	9.6	12	11.1	10.3	9.5	12.4	11.3	10.5	9.6			11.9	11.1	10.4	9.5	11.8	11	10.3	9.5	155
160	11.8	11.1	10.3	9.6	12.4	11.4	10.5	9.6	11.9	11	10.3	9.5	11.8	11	10.2	9.5	12.2	11.2	10.4	9.5			11.7	11	10.2	9.5	11.6	10.9	10.2	9.5	160
165	11.6	10.9	10.2	9.6	12.2	11.2	10.4	9.6	11.7	10.9	10.2	9.5	11.6	10.8	10.1	9.5	12	11.1	10.3	9.5			11.6	10.8	10.1	9.5	11.4	10.8	10.1	9.4	165
170	11.4	10.8	10.2	9.6	12	11.1	10.3	9.6	11.5	10.8	10.1	9.5	11.4	10.7	10.1	9.5	11.8	11	10.2	9.5			11.4	10.7	10.1	9.5	11.3	10.7	10	9.4	170
175	11.2	10.6	10.1	9.6	11.7	10.9	10.2	9.6	11.3	10.7	10.1	9.5	11.3	10.6	10	9.5	11.6	10.8	10.1	9.5			11.3	10.6	10	9.4	11.2	10.6	9.9	9.4	175
180	10.9	10.5	10	9.6	11.5	10.8	10.2	9.6	11.1	10.5	10	9.5	11.1	10.5	10	9.5	11.4	10.7	10.1	9.5			11.1	10.5	9.9	9.4	11	10.5	9.9	9.4	180
185	10.7	10.4	9.9	9.6	11.3	10.6	10.1	9.6	10.9	10.4	9.9	9.5	10.9	10.4	9.9	9.5	11.2	10.6	10	9.5			10.9	10.4	9.9	9.4	10.9	10.4	9.8	9.4	185
190	10.6	10.2	9.8	9.6	11	10.5	10	9.6	10.7	10.3	9.9	9.5	10.7	10.3	9.8	9.5	11.1	10.5	9.9	9.5			10.8	10.3	9.8	9.4	10.7	10.3	9.8	9.4	190
195	10.4	10.2	9.8	9.6	10.8	10.3	9.9	9.6	10.5	10.2	9.8	9.5	10.5	10.2	9.8	9.5	10.9	10.4	9.9	9.5			10.6	10.2	9.8	9.4	10.6	10.2	9.8	9.4	195
200	10.2	10.1	9.8	9.6	10.6	10.3	9.8	9.6	10.4	10.1	9.7	9.5	10.3	10.1	9.7	9.5	10.6	10.2	9.8	9.5			10.5	10.1	9.7	9.4	10.5	10.1	9.7	9.4	200
205	10.1	10	9.8	9.6	10.4	10.2	9.8	9.6	10.2	10	9.7	9.5	10	10	9.7	9.5	10.4	10.1	9.7	9.5			10.3	10	9.7	9.4	10.3	10	9.7	9.4	205
210	9.9	10	9.7	9.6	10.2	10.1	9.8	9.6	10.1	10	9.7	9.5	9.7	9.7	9.6	9.5	10.3	10	9.6	9.5			10.2	9.9	9.6	9.4	10.2	9.9	9.6	9.4	210
215	9.7	9.9	9.7	9.6	10	10	9.7	9.6	9.9	9.9	9.7	9.5	9.4	9.5	9.4	9.5	10.1	9.9	9.6	9.5			10.1	9.9	9.6	9.4	10	9.8	9.6	9.4	215
220	9.5	9.8	9.7	9.6	9.9	10	9.7	9.6	9.8	9.9	9.7	9.5	9.1	9.2	9.1	9.4	10	9.9	9.6	9.5			9.9	9.8	9.5	9.4	9.7	9.7	9.5	9.4	220
225	9.4	9.8	9.7	9.6	9.7	9.9	9.7	9.6	9.6	9.8	9.7	9.5	8.8	8.9	8.9	9.2	9.8	9.8	9.6	9.5			9.8	9.7	9.5	9.4	9.4	9.5	9.4	9.4	225
230	9.3	9.6	9.7	9.6	9.5	9.8	9.7	9.6	9.5	9.8	9.7	9.5	8.4	8.6	8.6	8.9	9.7	9.8	9.6	9.5			9.7	9.6	9.5	9.4	9.1	9.2	9.2	9.4	230
235	9.1	9.5	9.5	9.6	9.4	9.8	9.7	9.6	9.3	9.7	9.7	9.5	8.1	8.3	8.3	8.6	9.5	9.7	9.6	9.5			9.6	9.6	9.4	9.4	8.8	8.9	9	9.4	235
240	9	9.3	9.4	9.6	9.3	9.7	9.7	9.6	9.2	9.7	9.7	9.5	7.8	8	8.1	8.3	9.4	9.7	9.6	9.5			9.4	9.5	9.4	9.4	8.4	8.6	8.7	9.2	240
245	8.9	9.1	9.2	9.6	9.2	9.7	9.7	9.6	9	9.5	9.6	9.5	7.5	7.7	7.8	8	9.2	9.6	9.6	9.5			9.3	9.4	9.4	9.4	8.1	8.3	8.4	8.8	245
250	8.8	9	9	9.4	9.1	9.7	9.7	9.6	8.7	9.3	9.5	9.5	7.1	7.3	7.5	7.7	9.1	9.6	9.6	9.5			9.2	9.4	9.3	9.4	7.8	8	8.1	8.4	250
255	8.7	8.8	8.9	9.2	9	9.7	9.7	9.6	8.5	8.9	9.1	9.3	6.8	7	7.2	7.3	9	9.4	9.6	9.5			9	9.3	9.3	9.4	7.5	7.7	7.8	8.1	255
260	8.5	8.6	8.7	9	8.9	9.7	9.7	9.6	8.3	8.7	8.8	8.9	6.5	6.6	6.8	6.8	8.9	9.2	9.4	9.5			8.8	9.2	9.3	9.4	7.2	7.4	7.5	7.7	260
265	8.3	8.4	8.5		8.8	9.7	9.7	9.6	8.1	8.4	8.5	8.5	6.1	6.3	6.4	6.4	8.8	9.1	9.2	9.5			8.6	9	9.1	9.3	6.9	7.1	7.2	7.3	265
270	8.2	8.2	8.3		8.8	9.7	9.7	9.6	7.8	8	8.2	8.2	5.8	5.9	6.1	6	8.7	8.9	9	9.4			8.4	8.7	8.8	9	6.6	6.7	6.9	7	270
275	8	8	8.2		8.8	9.4	9.6	4.2	7.6	7.7	7.8	7.9	5.4	5.6	5.7	5.6	8.5	8.7	8.8	9.1			8.2	8.4	8.5	8.7	6.3	6.4	6.5	6.6	275
280	7.9				8.8	9.2	9.3		7.3	7.5	7.5	7.6	5.1	5.2	5.3	5.2	8.4	8.5	8.6	8.8			8	8.2	8.3	8.4	5.9	6.1	6.2	6.2	280
285					8.5	9	3.4		7.1	7.2	7.2		4.8	4.9	5	4.9	8.2	8.4	8.4	8.6			7.7	7.9	8	8	5.6	5.8			

Lifting capacities

Forces de levage

TK 69

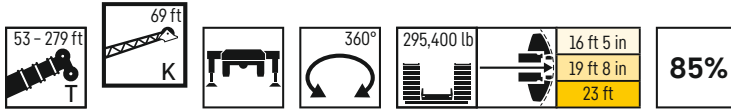

	261 ft				264 ft				270 ft 69 ft				276 ft				279 ft				
	0°	10°	20°	40°	0°	10°	20°	40°	0°	10°	20°	40°	0°	10°	20°	40°	0°	10°	20°	40°	
65	15.2				15				14.4				14								65
70	15.1				14.9				14.3				13.9				13.7				70
75	15	14			14.8	13.8			14.2				13.8				13.6				75
80	14.8	13.7			14.6	13.6			14.1	13.2			13.7	13			13.5	12.8			80
85	14.6	13.5	12.3		14.5	13.4			13.9	13			13.6	12.8			13.4	12.6			85
90	14.4	13.3	12.1		14.3	13.2	12.1		13.8	12.8	11.8		13.4	12.6	11.6		13.2	12.4			90
95	14.2	13.1	11.9		14.1	13	11.9		13.6	12.7	11.6		13.3	12.4	11.5		13.1	12.3	11.4		95
100	14	12.9	11.7		13.9	12.8	11.7		13.5	12.5	11.5		13.1	12.2	11.3		13	12.1	11.3		100
105	13.8	12.7	11.6	10	13.7	12.6	11.5	10	13.3	12.3	11.3	9.9	13	12	11.2		12.8	11.9	11.1		105
110	13.6	12.5	11.4	9.9	13.5	12.4	11.4	9.9	13.1	12.1	11.2	9.8	12.8	11.9	11.1	9.8	12.7	11.8	11	9.7	110
115	13.4	12.3	11.3	9.9	13.3	12.2	11.2	9.8	12.9	11.9	11.1	9.8	12.6	11.7	11	9.7	12.5	11.6	10.9	9.7	115
120	13.2	12.1	11.2	9.8	13.1	12	11.1	9.8	12.8	11.8	11	9.7	12.5	11.6	10.9	9.6	12.3	11.5	10.8	9.6	120
125	13.1	12	11	9.7	12.9	11.9	11	9.7	12.6	11.6	10.9	9.6	12.3	11.4	10.8	9.6	12.2	11.3	10.7	9.6	125
130	12.9	11.8	10.9	9.6	12.8	11.7	10.9	9.7	12.4	11.5	10.8	9.6	12.2	11.3	10.7	9.5	12.1	11.2	10.6	9.5	130
135	12.7	11.7	10.8	9.6	12.6	11.6	10.8	9.6	12.3	11.3	10.6	9.5	12.1	11.2	10.6	9.5	11.9	11.1	10.5	9.5	135
140	12.5	11.5	10.7	9.6	12.4	11.4	10.7	9.5	12.1	11.2	10.5	9.5	11.9	11.1	10.5	9.4	11.8	11	10.4	9.4	140
145	12.3	11.4	10.6	9.5	12.2	11.3	10.6	9.5	12	11.1	10.4	9.5	11.8	11	10.4	9.4	11.7	10.9	10.3	9.4	145
150	12.1	11.2	10.5	9.5	12	11.2	10.5	9.5	11.8	11	10.3	9.4	11.6	10.9	10.3	9.4	11.5	10.8	10.2	9.3	150
155	11.9	11.1	10.4	9.5	11.8	11.1	10.4	9.5	11.6	10.9	10.3	9.4	11.5	10.8	10.2	9.4	11.4	10.7	10.2	9.3	155
160	11.7	11	10.3	9.5	11.6	10.9	10.3	9.4	11.5	10.8	10.2	9.4	11.3	10.7	10.1	9.3	11.3	10.6	10.1	9.3	160
165	11.6	10.9	10.2	9.5	11.4	10.8	10.2	9.4	11.3	10.7	10.1	9.4	11.2	10.6	10	9.3	11.1	10.6	10	9.3	165
170	11.4	10.7	10.1	9.4	11.2	10.7	10.1	9.4	11.1	10.6	10	9.4	11.1	10.5	10	9.3	11	10.5	9.9	9.3	170
175	11.3	10.6	10	9.4	11	10.5	10	9.4	11	10.5	9.9	9.4	10.8	10.4	9.9	9.3	10.8	10.4	9.8	9.3	175
180	11.1	10.5	9.9	9.4	10.7	10.3	9.9	9.4	10.8	10.4	9.8	9.4	10.6	10.3	9.8	9.3	10.5	10.3	9.8	9.3	180
185	11	10.5	9.9	9.4	10.5	10.2	9.7	9.4	10.6	10.2	9.7	9.3	10.4	10.1	9.7	9.3	10.1	10	9.7	9.3	185
190	10.9	10.4	9.8	9.4	10.3	10	9.6	9.3	10.4	10.1	9.7	9.3	10.1	9.9	9.6	9.3	9.7	9.8	9.6	9.3	190
195	10.7	10.3	9.8	9.4	10	9.8	9.5	9.2	10.3	10	9.6	9.3	9.9	9.7	9.4	9.3	9.4	9.4	9.3	9.3	195
200	10.6	10.2	9.7	9.4	9.8	9.6	9.4	9.2	10.1	9.9	9.5	9.3	9.6	9.5	9.3	9.2	9	9.1	9	9.2	200
205	10.4	10.1	9.7	9.4	9.5	9.4	9.3	9.1	9.9	9.7	9.5	9.3	9.4	9.3	9.1	9.1	8.6	8.8	8.7	9	205
210	10.3	10	9.6	9.4	9.3	9.3	9.1	9.1	9.7	9.6	9.4	9.3	9.1	9.1	8.9	9	8.2	8.4	8.4	8.7	210
215	10.1	9.9	9.6	9.4	9	9.1	9	9	9.6	9.5	9.3	9.2	8.9	8.9	8.8	8.8	7.9	8.1	8.1	8.4	215
220	9.7	9.8	9.6	9.4	8.7	8.9	8.9	8.9	9.4	9.3	9.2	9.2	8.6	8.7	8.6	8.7	7.5	7.8	7.9	8.1	220
225	9.3	9.6	9.5	9.4	8.3	8.6	8.8	8.9	9.1	9.2	9.2	9.2	8.4	8.5	8.5	8.6	7.1	7.4	7.6	7.8	225
230	8.8	9.1	9.2	9.4	7.8	8.3	8.5	8.8	8.7	9	9.1	9.2	8.1	8.3	8.3	8.4	6.7	7.1	7.3	7.5	230
235	8.3	8.7	8.8	9.3	7.4	7.8	8.2	8.6	8.2	8.7	8.9	9.2	7.6	8.1	8.1	8.3	6.4	6.7	7	7.2	235
240	7.8	8.2	8.4	9	7	7.4	7.7	8.1	7.7	8.2	8.6	8.9	7.2	7.6	7.9	8.2	6	6.4	6.6	7	240
245	7.3	7.7	7.9	8.4	6.5	6.9	7.3	7.6	7.2	7.7	8.1	8.5	6.7	7.2	7.5	7.8	5.6	6	6.3	6.6	245
250	6.8	7.2	7.5	7.9	6.1	6.5	6.8	7.1	6.7	7.2	7.6	8	6.2	6.7	7	7.4	5.2	5.6	5.9	6.2	250
255	6.4	6.8	7	7.4	5.7	6	6.3	6.6	6.3	6.7	7.1	7.4	5.8	6.2	6.6	6.9	4.8	5.2	5.5	5.8	255
260	5.9	6.3	6.6	6.8	5.2	5.6	5.9	6.1	5.8	6.2	6.5	6.9	5.3	5.7	6.1	6.4	4.4	4.8	5.1	5.4	260
265	5.5	5.8	6.1	6.3	4.8	5.2	5.4	5.6	5.3	5.7	6	6.3	4.8	5.3	5.6	5.8	4	4.4	4.6	4.9	265
270	5.1	5.4	5.7	5.7	4.4	4.8	5	5.1	4.9	5.2	5.5	5.7	4.4	4.8	5.1	5.3	3.6	4	4.2	4.5	270
275	4.6	5	5.2	5.2	4	4.3	4.6	4.6	4.5	4.8	5	5.2	3.9	4.3	4.6	4.8	3.3	3.6	3.8	4	275
280	4.2	4.5	4.7	4.7	3.7	3.9	4.1	4.1	4.1	4.4	4.6	4.7	3.6	3.9	4.2	4.3	2.9	3.2	3.4	3.6	280
285	3.8	4.1	4.2	4.2	3.3	3.6	3.7	3.6	3.7	4	4.1	4.2	3.2	3.5	3.7	3.8	2.6	2.8	3	3.1	285
290	3.4	3.6	3.8	3.6	2.9	3.2	3.3	3.2	3.3	3.6	3.7	3.7	2.8	3.1	3.3	3.3	2.1	2.5	2.6	2.7	290
295	3	3.2	3.3	3.1	2.5	2.7	2.9	2.7	2.9	3.1	3.3	3.2	2.4	2.7	2.9	2.8	1.7	2	2.2	2.2	295
300	2.6	2.8	2.9	2.5	2.1	2.3	2.5	2.1	2.5	2.7	2.9	2.7	2	2.3	2.4	2.3			1.7	1.7	300
305	2.3	2.4	2.4	1.9	1.7	1.9	2		2.1	2.3	2.4	2.2		1.8	2						305
310	1.9	2	2						1.6	1.8	1.9										310

maxt_268_005_02001_00_000

Lifting capacities

Forces de levage

TK 92

53 - 279 ft
92 ft
K
360°
295,400 lb
16 ft 5 in
19 ft 8 in
23 ft
85%

	218 ft								226 ft								235 ft								241 ft								243 ft								253 ft								259 ft								
	92 ft																92 ft																																								
	0°	10°	20°	40°	0°	10°	20°	40°	0°	10°	20°	40°	0°	10°	20°	40°		0°	10°	20°	40°	0°	10°	20°	40°	0°	10°	20°	40°	0°	10°	20°	40°	0°	10°	20°	40°																				
60	10.4				11.1				9.9																											60																					
65	10.6				11.2				10.2					9.9												10.4										65																					
70	10.6				11.1				10.2					10.1																						70																					
75	10.4	9.6			10.9				10.2					10																						75																					
80	10.3	9.4			10.8	9.8			10	9.2				9.9	9.1																					80																					
85	10.2	9.2			10.6	9.6			9.9	9.1				9.8	9																					85																					
90	10	9.1	8.1		10.4	9.4			9.8	8.9				9.6	8.8																					90																					
95	9.8	8.9	7.9		10.3	9.2	8.1		9.6	8.8	7.8			9.5	8.7	7.8																				95																					
100	9.7	8.7	7.7		10.1	9	8		9.5	8.6	7.7			9.3	8.5	7.6																				100																					
105	9.5	8.6	7.6		9.9	8.9	7.8		9.3	8.5	7.5			9.2	8.4	7.5																				105																					
110	9.3	8.4	7.5		9.7	8.7	7.7		9.2	8.3	7.4			9.1	8.3	7.4																				110																					
115	9.2	8.2	7.3	6.1	9.6	8.5	7.5	6.2	9	8.2	7.3	6.1		8.9	8.1	7.3																			115																						
120	9	8.1	7.2	6	9.4	8.4	7.4	6.1	8.9	8	7.2	6		8.8	8	7.1	6																			120																					
125	8.9	7.9	7.1	6	9.2	8.2	7.3	6	8.7	7.9	7	5.9		8.7	7.8	7	5.9																			125																					
130	8.7	7.8	6.9	5.9	9	8.1	7.1	6	8.6	7.8	6.9	5.9		8.5	7.7	6.9	5.9																			130																					
135	8.5	7.6	6.8	5.9	8.9	7.9	7	5.9	8.5	7.6	6.8	5.9		8.4	7.6	6.8	5.8																			135																					
140	8.4	7.5	6.8	5.8	8.7	7.8	6.9	5.9	8.3	7.5	6.7	5.8		8.3	7.5	6.7	5.8																			140																					
145	8.2	7.4	6.7	5.8	8.5	7.6	6.8	5.8	8.2	7.4	6.7	5.8		8.1	7.3	6.6	5.7																			145																					
150	8.1	7.2	6.6	5.7	8.4	7.5	6.7	5.8	8	7.2	6.6	5.7	8	7.2	6.5	5.7	8.2	7.4	6.7	5.7	8	7.2	6.5	5.7											150																						
155	7.9	7.1	6.5	5.7	8.2	7.3	6.6	5.8	7.9	7.1	6.5	5.7	7.9	7.1	6.5	5.6	8.1	7.3	6.6	5.7	7.9	7.1	6.4	5.6											155																						
160	7.8	7	6.4	5.7	8.1	7.2	6.5	5.7	7.8	7	6.4	5.6	7.7	7	6.4	5.6	7.9	7.2	6.5	5.7	7.7	7	6.4	5.6											160																						
165	7.6	6.9	6.3	5.7	7.9	7.1	6.4	5.7	7.6	6.9	6.3	5.6	7.6	6.9	6.3	5.6	7.8	7	6.4	5.6	7.6	6.9	6.3	5.6											165																						
170	7.5	6.8	6.2	5.6	7.8	7	6.3	5.7	7.5	6.8	6.2	5.6	7.5	6.8	6.2	5.6	7.7	6.9	6.3	5.6	7.5	6.8	6.2	5.6											170																						
175	7.3	6.7	6.2	5.6	7.6	6.9	6.3	5.6	7.4	6.7	6.1	5.6	7.4	6.7	6.1	5.6	7.6	6.8	6.2	5.6	7.4	6.7	6.1	5.6											175																						
180	7.2	6.6	6.1	5.6	7.5	6.8	6.2	5.6	7.2	6.6	6.1	5.5	7.2	6.6	6.1	5.5	7.5	6.7	6.2	5.6	7.3	6.6	6.1	5.5											180																						
185	7	6.5	6.1	5.6	7.4	6.7	6.1	5.6	7.1	6.5	6	5.5	7.1	6.5	6	5.5	7.3	6.6	6.1	5.5	7.2	6.5	6	5.5											185																						
190	6.9	6.4	6	5.6	7.2	6.6	6.1	5.6	7	6.4	6	5.5	7	6.4	6	5.5	7.2	6.6	6	5.5	7	6.4	5.9	5.5											190																						
195	6.8	6.3	5.9	5.6	7.1	6.5	6	5.6	6.9	6.3	5.9	5.5	6.9	6.4	5.9	5.5	7.1	6.5	6	5.5	6.9	6.4	5.9	5.5											195																						
200	6.6	6.2	5.9	5.6	6.9	6.4	6	5.6	6.7	6.3	5.9	5.5	6.8	6.3	5.9	5.5	7	6.4	5.9	5.5	6.8	6.3	5.8	5.4											200																						
205	6.5	6.1	5.8	5.6	6.8	6.3	5.9	5.6	6.6	6.2	5.8	5.5	6.6	6.2	5.8	5.5	6.8	6.3	5.9	5.5	6.7	6.2	5.8	5.4											205																						
210	6.4	6.1	5.8	5.6	6.7	6.2	5.8	5.6	6.5	6.1	5.8	5.5	6.5	6.1	5.8	5.5	6.7	6.2	5.8	5.5	6.6	6.1	5.8	5.4											210																						
215	6.3	6	5.7	5.6	6.6	6.1	5.8	5.6	6.4	6	5.7	5.5	6.4	6	5.7	5.5	6.6	6.1	5.8	5.5	6.5	6.1	5.7	5.4											215																						
220	6.2	6	5.7	5.6	6.4	6.1	5.7	5.6	6.3	6	5.7	5.5	6.3	6	5.7	5.5	6.5	6	5.7	5.5	6.4	6	5.7	5.4											220																						
225	6.1	5.9	5.7	5.6	6.3	6	5.7	5.6	6.2	5.9	5.6	5.5	6.2	5.9	5.6	5.5	6.4	6	5.7	5.5	6.3	5.9	5.7	5.4											225																						
230	5.9	5.9	5.7	5.6	6.2	6	5.7	5.6	6.1	5.9	5.6	5.5	6.1	5.8	5.6	5.5	6.2	5.9	5.6	5.5	6.2	5.9	5.6	5.4											230																						
235	5.8	5.8	5.7	5.6	6.1	5.9	5.7	5.6	6	5.8	5.6	5.5	6	5.8	5.6	5.5	6.1	5.8	5.6	5.5	6.1	5.8	5.6	5.4											235																						
240	5.7	5.7	5.7	5.6	6	5.8	5.7	5.6	5.9	5.8	5.6	5.5	5.9	5.8	5.6	5.5	6	5.8	5.6	5.5	6	5.8	5.6	5.4											240																						
245	5.6	5.7	5.6	5.6	5.8	5.8	5.6	5.6	5.8	5.7	5.6	5.5	5.8	5.7	5.6	5.5	5.9	5.8	5.6	5.5	5.9	5.7	5.5	5.4											245																						
250	5.6	5.7	5.6	5.6	5.7	5.7	5.6	5.6	5.7	5.7	5.6	5.5	5.8	5.7	5.6	5.5	5.8	5.7	5.6	5.5	5.8	5.7	5.5	5.4											250																						
255	5.5	5.7	5.6	5.6	5.6	5.7	5.6	5.6	5.6	5.7	5.6	5.5	5.7	5.7	5.6	5.5	5.7	5.7	5.6	5.5	5.7	5.7	5.5	5.4											255																						
260	5.4	5.7	5.6	5.6	5.6	5.7	5.6	5.6	5.5	5.6	5.6	5.5	5.6	5.6	5.6	5.5	5.6	5.6	5.6	5.5	5.7	5.6	5.5	5.4											260																						
265	5.4	5.7	5.6	5.6	5.5	5.7	5.6	5.6	5.5	5.6	5.6	5.5	5.4	5.6	5.6	5.5	5.5	5.6	5.6	5.5	5.6	5.6	5.5	5.4											265																						
270	5.3	5.7	5.6	5.6	5.4	5.7	5.6	5.6	5.4	5.6	5.6	5.5	5.2	5.5	5.6	5.5	5.5	5.6	5.6	5.5	5.5	5.6	5.5	5.4											270																						
275	5.2	5.7	5.6	5.6	5.4	5.7	5.6	5.6	5.4	5.6	5.6	5.5	4.9	5.3	5.5	5.5	5.4	5.6	5.6	5.5	5.4	5.5	5.5	5.4											275																						
280	5.2	5.7	5.6	5.6	5.3	5.7	5.6	5.6	5.3	5.6	5.6	5.5	4.6	5	5.2	5.3	5.4	5.6	5.6	5.5	5.4	5.5	5.5	5.4											280																						
285	5.2	5.7	5.6		5.2	5.7	5.6	5.6	5.3	5.6	5.6	5.5	4.4	4.7	4.9	4.9	5.3	5.6	5.6	5.5	5.3	5.5	5.5	5.4											285																						
290	5.2	5.7	5.6		5.2	5.7	5.6	3.5	5.2	5.6	5.6	5.5	4.1	4.4	4.5	4.5	5.3	5.6	5.6	5.5	5.3	5.5	5.5	5.4											290																						
295	5.2	5.7			5.2	5.7	5.6		5.1	5.6	5.6	5.5	3.8	4.1	4.2	4	5.2	5.6	5.6	5.5	5.2	5.5	5.5	5.4											295																						
300					5.2	5.7	5.6		5.1	5.6	5.6		3.6	3.8	3.9	3.8	5.2	5.6	5.6	5.5	5.2	5.5	5.5	5.4											300																						
305					5.2	5.7	2.1		5.1	5.6	5.6		3.3	3.5	3.5	3.6	5.1	5.6	5.6	5.5	5.2	5.5	5.5	5.4											305																						
310																																																									

Lifting capacities

Forces de levage

TK 92

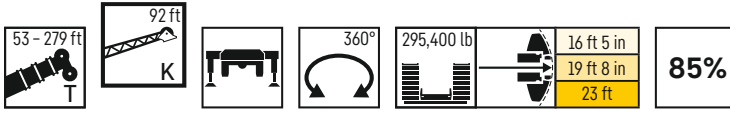

	261 ft				264 ft				270 ft 92 ft				276 ft				279 ft				
	0°	10°	20°	40°	0°	10°	20°	40°	0°	10°	20°	40°	0°	10°	20°	40°	0°	10°	20°	40°	
70	9.7				9.6				9.2												70
75	9.7				9.6				9.3				9.1				9				75
80	9.6				9.6				9.3				9.1				9				80
85	9.5				9.5				9.2				9				8.9				85
90	9.4	8.7			9.4	8.7			9.1	8.5			8.9	8.4			8.8				90
95	9.3	8.6			9.2	8.5			9	8.4			8.8	8.2			8.7	8.2			95
100	9.2	8.4			9.1	8.4			8.9	8.2			8.7	8.1			8.6	8.1			100
105	9.1	8.3	7.5		9	8.3	7.4		8.8	8.1	7.4		8.6	8			8.5	7.9			105
110	8.9	8.2	7.4		8.9	8.1	7.3		8.7	8	7.3		8.5	7.9	7.2		8.4	7.8	7.1		110
115	8.8	8.1	7.2		8.8	8	7.2		8.6	7.9	7.1		8.4	7.8	7.1		8.3	7.7	7.1		115
120	8.7	7.9	7.1		8.6	7.9	7.1		8.4	7.8	7		8.3	7.7	7		8.2	7.6	6.9		120
125	8.6	7.8	7	5.9	8.5	7.8	7	5.9	8.3	7.7	6.9		8.2	7.6	6.9		8.1	7.5	6.8		125
130	8.4	7.7	6.9	5.8	8.4	7.7	6.9	5.8	8.2	7.6	6.8	5.8	8.1	7.5	6.8	5.8	8	7.4	6.7	5.8	130
135	8.3	7.6	6.8	5.8	8.3	7.5	6.8	5.8	8.1	7.4	6.7	5.7	8	7.4	6.7	5.7	7.9	7.3	6.6	5.7	135
140	8.2	7.5	6.7	5.7	8.2	7.4	6.7	5.7	8	7.3	6.6	5.7	7.9	7.3	6.6	5.7	7.8	7.2	6.6	5.7	140
145	8.1	7.4	6.6	5.7	8.1	7.3	6.6	5.7	7.9	7.2	6.5	5.7	7.8	7.1	6.5	5.6	7.7	7.1	6.5	5.6	145
150	8	7.2	6.5	5.7	7.9	7.2	6.5	5.6	7.8	7.1	6.4	5.6	7.7	7	6.4	5.6	7.6	7	6.4	5.6	150
155	7.9	7.1	6.5	5.6	7.8	7.1	6.4	5.6	7.7	7	6.4	5.6	7.6	7	6.3	5.5	7.5	6.9	6.3	5.5	155
160	7.7	7	6.4	5.6	7.7	7	6.3	5.6	7.6	6.9	6.3	5.5	7.5	6.9	6.2	5.5	7.4	6.8	6.2	5.5	160
165	7.6	6.9	6.3	5.6	7.6	6.9	6.3	5.6	7.5	6.8	6.2	5.5	7.4	6.8	6.2	5.5	7.4	6.8	6.2	5.5	165
170	7.5	6.8	6.3	5.6	7.5	6.8	6.2	5.5	7.4	6.7	6.2	5.5	7.3	6.7	6.1	5.5	7.3	6.7	6.1	5.4	170
175	7.4	6.7	6.2	5.5	7.4	6.7	6.1	5.5	7.3	6.6	6.1	5.5	7.2	6.6	6.1	5.5	7.2	6.6	6	5.4	175
180	7.3	6.6	6.1	5.5	7.3	6.6	6.1	5.5	7.2	6.5	6	5.5	7.1	6.5	6	5.4	7.1	6.5	6	5.4	180
185	7.2	6.5	6	5.5	7.2	6.5	6	5.5	7.1	6.4	6	5.5	7	6.4	6	5.4	7	6.4	5.9	5.4	185
190	7.1	6.4	6	5.5	7.1	6.4	5.9	5.5	7	6.3	5.9	5.4	6.9	6.3	5.9	5.4	6.8	6.3	5.9	5.4	190
195	7	6.4	5.9	5.5	7	6.4	5.9	5.4	6.9	6.3	5.8	5.4	6.8	6.2	5.8	5.4	6.7	6.2	5.8	5.4	195
200	6.9	6.3	5.9	5.4	6.9	6.3	5.8	5.4	6.8	6.2	5.8	5.4	6.7	6.2	5.8	5.4	6.5	6.1	5.8	5.4	200
205	6.8	6.2	5.8	5.4	6.8	6.2	5.8	5.4	6.7	6.2	5.8	5.4	6.7	6.1	5.7	5.4	6.4	6	5.7	5.4	205
210	6.7	6.2	5.8	5.4	6.7	6.2	5.8	5.4	6.6	6.1	5.7	5.4	6.6	6.1	5.7	5.4	6.2	5.9	5.6	5.4	210
215	6.6	6.1	5.7	5.4	6.6	6.1	5.7	5.4	6.5	6	5.7	5.4	6.5	6	5.7	5.4	6	5.8	5.6	5.4	215
220	6.5	6	5.7	5.4	6.5	6	5.7	5.4	6.4	6	5.7	5.4	6.4	6	5.6	5.4	5.9	5.7	5.5	5.3	220
225	6.4	6	5.7	5.4	6.4	6	5.7	5.4	6.3	5.9	5.6	5.4	6.3	5.9	5.6	5.4	5.7	5.5	5.4	5.3	225
230	6.2	5.9	5.6	5.4	6.2	5.9	5.6	5.4	6.2	5.9	5.6	5.4	6.2	5.9	5.6	5.4	5.5	5.4	5.3	5.3	230
235	6.1	5.8	5.6	5.4	6.1	5.8	5.6	5.4	6.1	5.8	5.6	5.4	6.1	5.8	5.6	5.4	5.4	5.3	5.2	5.2	235
240	5.9	5.7	5.5	5.4	5.9	5.8	5.6	5.4	6	5.7	5.5	5.4	6	5.7	5.5	5.4	5.2	5.2	5.1	5.2	240
245	5.7	5.6	5.5	5.4	5.6	5.7	5.5	5.4	5.8	5.7	5.5	5.4	5.9	5.7	5.5	5.4	5	5.1	5.1	5.1	245
250	5.5	5.4	5.4	5.4	5.3	5.4	5.4	5.4	5.5	5.6	5.5	5.4	5.7	5.6	5.5	5.4	4.8	5	5	5.1	250
255	5.3	5.2	5.3	5.4	5	5.2	5.3	5.4	5.2	5.4	5.4	5.4	5.4	5.5	5.4	5.4	4.5	4.8	4.9	5	255
260	5	5.1	5.1	5.4	4.7	4.9	5	5.3	5	5.1	5.2	5.4	5	5.3	5.4	5.4	4.2	4.6	4.8	5	260
265	4.8	4.9	4.9	5.2	4.4	4.6	4.7	5.1	4.7	4.9	5	5.3	4.7	5	5.2	5.4	3.8	4.3	4.7	4.9	265
270	4.6	4.7	4.8	5	4.1	4.3	4.5	4.8	4.4	4.6	4.7	5.1	4.3	4.6	4.9	5.3	3.5	4	4.3	4.7	270
275	4.4	4.6	4.6	4.8	3.8	4.1	4.2	4.5	4.1	4.4	4.5	4.8	3.9	4.3	4.5	5	3.1	3.6	4	4.4	275
280	4.2	4.4	4.5	4.7	3.5	3.8	4	4.2	3.9	4.1	4.2	4.5		3.9	4.2	4.6	2.8	3.2	3.6	3.9	280
285	3.9	4.2	4.3	4.5	3.2	3.5	3.7	3.9	3.6	3.8	4	4.2		3.6	3.8	4.2		2.9	3.2	3.5	285
290	3.5	3.9	4.1	4.2	2.9	3.2	3.4	3.6	3.3	3.6	3.8	3.9			3.5	3.7			2.9	3.1	290
295	3.1	3.5	3.8	3.8	2.6	2.9	3.1	3.2	2.9	3.3	3.5	3.6				3.3			2.5	2.7	295
300	2.8	3.1	3.3	3.3	2.2	2.6	2.8	2.8	2.6	3	3.2	3.3				2.9					300
305	2.4	2.7	2.9	2.8	1.7	2.2	2.4	2.3	2.2	2.6	2.8	2.8				2.5					305
310	2	2.3	2.5	2.2		1.7	1.9	1.7	1.7	2.2	2.4	2.3				1.8					310
315			2	1.5						1.7	2	1.7									315

maxt_268_005_03001_00_000

Lifting capacities Forces de levage

TK 115

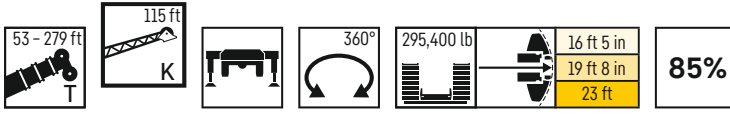

	53 ft				157 ft				174 ft				183 ft				191 ft				201 ft				209 ft					
	0°	10°	20°	40°	0°	10°	20°	40°	0°	10°	20°	40°	0°	10°	20°	40°	0°	10°	20°	40°	0°	10°	20°	40°	0°	10°	20°	40°		
28	6.2																												28	
30	6.6																												30	
32	6.8																												32	
34	7.1																												34	
36	7.2																												36	
38	7.4																												38	
40	7.4																												40	
45	7.5																												45	
50	7.4	6.7			7.2																								50	
55	7.2	6.5			7.5			7.2				6.1																	55	
60	7.1	6.2			7.8			7.5				6.2				7.1					5.9								60	
65	6.9	5.9	5.2		8			7.8				6.4			7.4					6.1				6.9					65	
70	6.7	5.6	5		8.2	6.8		7.9				6.6			7.6					6.3				7.2					70	
75	6.5	5.4	4.8		8.2	6.8		8	6.7			6.8			7.7					6.5				7.3					75	
80	6.3	5.2	4.6		8.2	6.7		8	6.7			6.9	5.9		7.8	6.5				6.6				7.4					80	
85	6	5	4.4		8.1	6.6		8	6.6			6.9	5.9		7.8	6.5				6.7	5.7			7.4	6.3				85	
90	5.7	4.8	4.2		8	6.5	5.1	7.9	6.5			6.9	5.8		7.8	6.5				6.7	5.7			7.5	6.3				90	
95	5.3	4.6	4	3.4	7.8	6.4	5	7.8	6.4	5		6.9	5.8		7.6	6.4				6.7	5.7			7.4	6.3				95	
100	5	4.4	3.9	3.3	7.6	6.2	4.9	7.6	6.3	5		6.9	5.7	4.5		7.5	6.3	4.9		6.7	5.7			7.3	6.2				100	
105	4.7	4.3	3.7	3.1	7.4	6.1	4.9	7.4	6.2	4.9		6.8	5.6	4.5		7.3	6.2	4.9		6.7	5.6	4.4		7.1	6.1	4.8			105	
110	4.5	4.1	3.6	3.1	7.2	6	4.8	7.2	6.1	4.8		6.6	5.5	4.4		7.1	6	4.8		6.6	5.5	4.4		7	6	4.7			110	
115	4.2	3.9	3.5	3	7	5.9	4.7	7	6	4.7		6.5	5.4	4.4		7	5.9	4.7		6.4	5.4	4.4		6.9	5.9	4.7			115	
120	3.9	3.8	3.4	2.9	6.8	5.7	4.6	6.9	5.8	4.6	3.2	6.3	5.3	4.3		6.8	5.8	4.7		6.3	5.3	4.3		6.7	5.7	4.6			120	
125	3.7	3.6	3.2	2.9	6.6	5.6	4.5	6.7	5.7	4.6	3.2	6.2	5.2	4.2	3	6.6	5.7	4.6	3.2	6.2	5.2	4.2		6.6	5.6	4.6			125	
130	3.5	3.5	3.2	2.8	6.4	5.4	4.5	6.5	5.6	4.5	3.2	6	5.1	4.2	3	6.5	5.6	4.5	3.2	6	5.1	4.2	3	6.4	5.5	4.5	3.1		130	
135	3.4	3.4	3.1	2.8	6.2	5.3	4.4	6.3	5.4	4.4	3.2	5.9	5	4.1	3	6.3	5.4	4.4	3.1	5.9	5	4.2	3	6.3	5.4	4.4	3.1		135	
140	3.2	3.4	3.1	2.8	6.1	5.2	4.3	6.2	5.3	4.4	3.1	5.7	4.9	4.1	3	6.2	5.3	4.4	3.1	5.7	5	4.1	3	6.1	5.3	4.3	3.1		140	
145	3.1	3.4	3.1	2.8	5.9	5.1	4.2	6	5.1	4.3	3.1	5.6	4.8	4	3	6	5.1	4.3	3.1	5.6	4.9	4.1	3	6	5.2	4.3	3.1		145	
150	3	3.3	3.1	2.8	5.7	4.9	4.1	5.8	5	4.2	3.1	5.5	4.7	4	3	5.9	5	4.2	3.1	5.5	4.8	4	3	5.8	5	4.2	3.1		150	
155	3	3.3	3.1		5.5	4.8	4.1	5.7	4.9	4.1	3.1	5.3	4.6	3.9	3	5.7	4.9	4.2	3.1	5.4	4.7	4	3	5.7	4.9	4.2	3.1		155	
160	3	3.3			5.3	4.7	4	5.5	4.8	4	3.1	5.2	4.6	3.9	3	5.6	4.8	4.1	3.1	5.3	4.6	3.9	3	5.6	4.8	4.1	3.1		160	
165					5.2	4.6	4	5.3	4.7	4	3.1	5.1	4.5	3.8	3	5.4	4.7	4.1	3.1	5.1	4.5	3.9	3	5.5	4.7	4.1	3.1		165	
170					5	4.5	3.9	5.1	4.6	4	3.1	4.9	4.4	3.8	3	5.3	4.6	4	3.1	5	4.4	3.8	3	5.3	4.6	4	3.1		170	
175					4.9	4.3	3.8	5.1	5	4.5	3.9	4.8	4.3	3.7	3	5.2	4.5	3.9	3.1	4.9	4.3	3.8	3	5.2	4.5	3.9	3.1		175	
180					4.7	4.2	3.8	5.1	4.9	4.3	3.9	4.7	4.2	3.7	3	5	4.4	3.9	3.1	4.8	4.3	3.7	3	5.1	4.4	3.9	3.1		180	
185					4.6	4.2	3.7	5.1	4.7	4.2	3.8	4.6	4.1	3.7	3	4.9	4.3	3.9	3.1	4.7	4.2	3.7	3	5	4.4	3.9	3.1		185	
190					4.4	4.1	3.7	5.1	4.6	4.1	3.8	4.5	4.1	3.6	3	4.7	4.2	3.8	3.1	4.6	4.1	3.7	3	4.8	4.3	3.8	3.1		190	
195					4.3	4	3.6	5.1	4.5	4.1	3.7	4.3	4	3.6	3	4.6	4.1	3.8	3.1	4.4	4	3.6	3	4.7	4.2	3.8	3.1		195	
200					4.1	3.9	3.6	5.1	4.4	4	3.7	4.2	3.9	3.6	3	4.5	4	3.7	3.1	4.3	3.9	3.6	2.9	4.6	4.1	3.7	3.1		200	
205					4	3.9	3.6	5.1	4.2	3.9	3.6	4.1	3.8	3.5	3	4.4	4	3.7	3.1	4.2	3.9	3.6	2.8	4.5	4	3.7	2.9		205	
210					3.9	3.8	3.6	5.1	4.1	3.9	3.6	4	3.8	3.5	3	4.3	3.9	3.6	3.1	4.1	3.8	3.5	2.8	4.4	3.9	3.6	2.9		210	
215					3.8	3.7	3.5	5.1	4	3.8	3.6	3.9	3.7	3.5	3	4.2	3.8	3.6	3.1	4	3.7	3.5	2.8	4.3	3.9	3.6	2.9		215	
220					3.7	3.7	3.5	5.1	3.9	3.7	3.5	4	3.8	3.7	3	4.1	3.8	3.5	3.1	4	3.7	3.4	2.8	4.2	3.8	3.5	2.9		220	
225					3.6	3.6	3.5	5.1	3.8	3.7	3.5	3.7	3.6	3.4	3	3.9	3.7	3.5	3.1	3.9	3.7	3.4	2.8	4.1	3.7	3.5	2.9		225	
230					3.5	3.6	3.5	5.1	3.7	3.6	3.5	3.6	3.6	3.4	3	3.9	3.7	3.5	3.1	3.8	3.6	3.4	2.8	4	3.7	3.4	2.9		230	
235					3.4	3.6	3.5	5.1	3.6	3.6	3.4	3.6	3.5	3.4	3	3.8	3.6	3.4	3.1	3.7	3.6	3.4	2.8	3.9	3.7	3.4	2.9		235	
240					3.3	3.5	3.5	5.1	3.5	3.6	3.4	3.5	3.5	3.4	3	3.7	3.6	3.4	3.1	3.6	3.5	3.4	2.8	3.8	3.6	3.4	2.9		240	
245					3.3	3.5	3.5		3.5	3.5	3.4	3.4	3.5	3.4	3	3.6	3.5	3.4	3.1	3.5	3.5	3.4	2.8	3.7	3.6	3.4	2.9		245	
250					3.2	3.5	3.5		3.4	3.5	3.4	3.3	3.4	3.4	3	3.5	3.5	3.4	3.1	3.4	3.4	3.4	2.8	3.6	3.5	3.4	2.9		250	
255					3.2	3.5	3.5		3.3	3.5	3.4	3.3	3.4	3.4	3	3.4	3.5	3.4	3.1	3.4	3.4	3.3	2.8	3.5	3.5	3.3	2.9		255	
260					3.1	3.5			3.2	3.4	3.4		3.2	3.4	3.4	3	3.4	3.4	3.4	3.1	3.3	3.4	3.3	2.8	3.5	3.4	3.3	2.9		260
265					3.1				3.2	3.4	3.4		3.2	3.4	3.4	3	3.3	3.4	3.4	3.1	3.3	3.4	3.3	2.8	3.4	3.4	3.3	2.9		265
270									3.2	3.4	3.4		3.1	3.4	3.4		3.2	3.4	3.4	3.1	3.2	3.4	3.3	2.8	3.4	3.4	3.3	2.9		270
275									3.1	3.4	3.4		3.1	3.4	3.4		3.2	3.4	3.4	3.1	3.2	3.4	3.3	2.8	3.3	3.4	3.3	2.9		275
280									3.1	3.4			3.1	3.4	3.4		3.1	3.4	3.4		3.1	3.4	3.3	2.8	3.2	3.4	3.3	2.9		280
285									3.1	3.4			3.1	3.4	3.4		3.1	3.4	3.4		3.1	3.4	3.3		3.2	3.4	3.3	2.9		285
290													3.1				3.1	3.4	3.4		3.1	3.4	3.3		3.1	3.4	3.3	2.9		290
295																	3.1	3.4			3.1	3.4	3.3		3.1	3.4	3.3			295
300																	3.1				3.1	3.4			3.1	3.4	3.3			300
305																					3.1				3.1	3.4	3.3			305
310																														

Lifting capacities

Forces de levage

TK 115

53 - 279 ft
115 ft
360°
295,400 lb
16 ft 5 in
19 ft 8 in
23 ft
85%

	218 ft				226 ft				235 ft				241 ft				243 ft				253 ft				259 ft				
	0°	10°	20°	40°	0°	10°	20°	40°	0°	10°	20°	40°	0°	10°	20°	40°	0°	10°	20°	40°	0°	10°	20°	40°	0°	10°	20°	40°	
65	5.9																												65
70	6.1				6.6					5.8				5.6															70
75	6.3				6.8					6				5.8															75
80	6.4				7					6.2				6															80
85	6.5				7					6.3				6.1															85
90	6.6	5.7			7.1	6.1				6.3	5.5			6.2															90
95	6.6	5.7			7.1	6				6.4	5.5			6.2	5.4														95
100	6.6	5.6			7	6				6.4	5.5			6.3	5.4												5.9	5.2	100
105	6.6	5.6	4.5		6.9	5.9				6.4	5.5			6.3	5.4														105
110	6.5	5.5	4.4		6.8	5.8	4.6			6.4	5.4	4.4		6.3	5.4														110
115	6.4	5.4	4.4		6.7	5.8	4.6			6.3	5.4	4.3		6.2	5.3	4.3													115
120	6.3	5.3	4.3		6.5	5.7	4.5			6.2	5.3	4.3		6.1	5.2	4.2													120
125	6.2	5.2	4.3		6.4	5.6	4.5			6.1	5.2	4.2		6	5.2	4.2													125
130	6	5.2	4.2		6.3	5.5	4.4			6	5.1	4.2		5.9	5.1	4.2													130
135	5.9	5.1	4.2	3	6.2	5.4	4.4	3.1		5.8	5	4.2		5.8	5	4.1													135
140	5.8	5	4.1	3	6	5.2	4.3	3.1		5.7	5	4.1	3	5.7	4.9	4.1	3												140
145	5.6	4.9	4.1	3	5.9	5.1	4.3	3.1		5.6	4.9	4	3	5.6	4.9	4	3												145
150	5.5	4.8	4	3	5.8	5	4.2	3.1		5.5	4.8	4	3	5.4	4.8	4	3												150
155	5.4	4.7	4	3	5.7	4.9	4.2	3.1		5.4	4.7	4	3	5.3	4.7	3.9	3												155
160	5.3	4.6	3.9	3	5.5	4.8	4.1	3.1		5.3	4.6	3.9	3	5.2	4.6	3.9	3												160
165	5.2	4.5	3.9	3	5.4	4.7	4.1	3		5.2	4.5	3.9	3	5.1	4.5	3.9	3												165
170	5.1	4.4	3.9	3	5.3	4.6	4	3		5.1	4.5	3.9	3	5	4.4	3.8	3												170
175	5	4.3	3.8	3	5.2	4.5	4	3		5	4.4	3.8	3	4.9	4.4	3.8	3												175
180	4.9	4.3	3.8	3	5.1	4.4	3.9	3.1		4.9	4.3	3.8	3	4.8	4.3	3.8	3												180
185	4.8	4.2	3.7	3.1	5	4.3	3.9	3.1		4.8	4.2	3.7	3	4.8	4.2	3.7	3												185
190	4.7	4.1	3.7	3.1	4.9	4.3	3.8	3.1		4.7	4.1	3.7	3.1	4.7	4.1	3.7	3												190
195	4.6	4.1	3.7	3.1	4.8	4.2	3.8	3.1		4.6	4.1	3.6	3.1	4.6	4	3.6	3												195
200	4.5	4	3.6	3.1	4.7	4.1	3.7	3.1		4.5	4	3.6	3.1	4.5	4	3.6	3												200
205	4.4	3.9	3.6	3.1	4.6	4.1	3.7	3.1		4.4	3.9	3.6	3.1	4.4	3.9	3.6	3												205
210	4.2	3.9	3.6	3	4.4	4	3.6	3.1		4.3	3.9	3.5	3.1	4.3	3.9	3.5	3												210
215	4.1	3.8	3.5	2.9	4.3	3.9	3.6	3		4.2	3.8	3.5	3.1	4.2	3.8	3.5	3												215
220	4.1	3.7	3.5	2.9	4.2	3.8	3.5	3		4.1	3.8	3.5	3	4.2	3.7	3.5	3												220
225	4	3.7	3.4	2.9	4.2	3.8	3.5	3		4.1	3.7	3.4	3	4.1	3.7	3.4	3												225
230	3.9	3.6	3.4	2.9	4.1	3.7	3.4	3		4	3.6	3.4	3	4	3.6	3.4	3												230
235	3.8	3.6	3.4	2.9	4	3.6	3.4	3		3.9	3.6	3.4	3	3.9	3.6	3.4	3												235
240	3.7	3.6	3.3	2.9	3.9	3.6	3.4	3		3.8	3.5	3.3	3	3.8	3.5	3.3	3												240
245	3.7	3.5	3.3	2.9	3.8	3.6	3.3	3		3.8	3.5	3.3	3	3.8	3.5	3.3	3												245
250	3.6	3.5	3.3	2.9	3.7	3.5	3.3	3		3.7	3.5	3.3	3	3.7	3.4	3.3	3												250
255	3.5	3.4	3.3	2.9	3.7	3.5	3.3	3		3.6	3.4	3.3	3	3.6	3.4	3.3	3												255
260	3.4	3.4	3.3	2.9	3.6	3.5	3.3	3		3.5	3.4	3.3	3	3.6	3.4	3.2	3												260
265	3.4	3.4	3.3	2.9	3.5	3.4	3.3	3		3.5	3.4	3.3	3	3.5	3.4	3.2	3												265
270	3.3	3.3	3.3	2.9	3.4	3.4	3.3	3		3.4	3.3	3.3	3	3.4	3.3	3.2	3												270
275	3.3	3.3	3.3	2.9	3.4	3.3	3.3	3		3.3	3.3	3.3	3	3.4	3.3	3.2	3												275
280	3.2	3.3	3.3	2.9	3.3	3.3	3.3	3		3.3	3.3	3.3	3	3.3	3.3	3.2	3												280
285	3.2	3.3	3.3	2.9	3.3	3.3	3.3	3		3.2	3.3	3.2	3	3.2	3.3	3.2	3												285
290	3.1	3.3	3.3	2.9	3.2	3.3	3.3	3		3.2	3.2	3.2	3	3.1	3.2	3.2	3												290
295	3.1	3.3	3.3	2.9	3.2	3.3	3.3	3		3.2	3.2	3.2	3	2.9	3.1	3.2	3												295
300	3	3.3	3.3		3.1	3.3	3.3	3		3.1	3.2	3.2	3	2.8	3	3.1	3												300
305	3	3.3	3.3		3.1	3.3	3.3	3		3.1	3.2	3.2	3	2.6	2.8	2.9	3												305
310	3	3.3	3.3		3	3.3	3.3	2.2		3	3.2	3.2	3	2.4	2.6	2.7	2.8												310
315	3	3.3	3.3		3	3.3	3.3			3	3.2	3.2	3	2.3	2.4	2.5	2.6												315
320	3	3.3			3	3.3	3.3			3	3.2	3.2		2.1	2.3	2.3	2.4												320
325	3				3	3.3				3	3.2	3.2		1.9	2.1	2.1													325
330					3	3.3				3	3.2	3.2		1.7	1.8	1.8													330
335										3	3.2																		335
340										3																			340
345																													345
350																													350
355																													355

maxt_268_005_04001_00_000

Lifting capacities

Forces de levage

TK 115

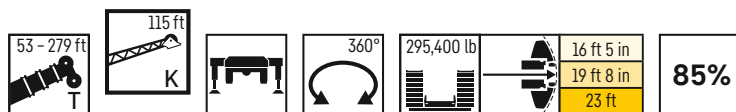

	261 ft				264 ft				270 ft				276 ft				279 ft					
	115 ft																					
	0°	10°	20°	40°	0°	10°	20°	40°	0°	10°	20°	40°	0°	10°	20°	40°	0°	10°	20°	40°		
75	5.5				5.5																75	
80	5.7				5.6				5.3					5.1				5				80
85	5.9				5.8				5.5					5.3				5.2				85
90	6				5.9				5.6					5.4				5.3				90
95	6.1				6				5.7					5.5				5.4				95
100	6.1	5.3			6	5.3			5.7					5.6				5.5				100
105	6.1	5.3			6	5.3			5.8	5.1				5.6	5			5.5	4.9			105
110	6.1	5.3			6	5.3			5.8	5.1				5.6	5			5.5	4.9			110
115	6.1	5.3			6	5.2			5.8	5.1				5.6	5			5.6	4.9			115
120	6	5.2	4.2		6	5.2	4.2		5.8	5.1				5.6	5			5.6	4.9			120
125	5.9	5.2	4.2		5.9	5.1	4.2		5.7	5	4.1			5.6	4.9	4		5.5	4.9	4		125
130	5.8	5.1	4.1		5.8	5.1	4.1		5.6	4.9	4.1			5.5	4.9	4		5.5	4.8	4		130
135	5.7	5	4.1		5.7	5	4.1		5.6	4.9	4			5.5	4.8	4		5.4	4.8	3.9		135
140	5.6	4.9	4.1		5.6	4.9	4.1		5.5	4.8	4			5.4	4.8	3.9		5.3	4.7	3.9		140
145	5.5	4.9	4	2.9	5.5	4.9	4		5.4	4.8	4			5.3	4.7	3.9		5.2	4.7	3.9		145
150	5.4	4.8	4	3	5.4	4.8	4	2.9	5.3	4.7	3.9	2.9		5.2	4.6	3.9		5.2	4.6	3.8		150
155	5.3	4.7	4	3	5.3	4.7	3.9	2.9	5.2	4.6	3.9	2.9		5.1	4.5	3.8	2.9	5.1	4.5	3.8	2.8	155
160	5.2	4.6	3.9	2.9	5.2	4.6	3.9	2.9	5.1	4.5	3.8	2.9		5	4.5	3.8	2.9	5	4.4	3.8	2.9	160
165	5.1	4.5	3.9	2.9	5.1	4.5	3.8	2.9	5	4.5	3.8	2.9		5	4.4	3.7	2.9	4.9	4.4	3.7	2.9	165
170	5	4.5	3.8	2.9	5	4.4	3.8	2.9	4.9	4.4	3.8	2.9		4.9	4.3	3.7	2.9	4.9	4.3	3.7	2.9	170
175	4.9	4.4	3.8	2.9	4.9	4.4	3.8	2.9	4.9	4.3	3.7	2.9		4.8	4.3	3.7	2.9	4.8	4.2	3.7	2.9	175
180	4.9	4.3	3.8	2.9	4.8	4.3	3.8	2.9	4.8	4.2	3.7	2.9		4.7	4.2	3.7	2.9	4.7	4.2	3.6	2.9	180
185	4.8	4.2	3.7	2.9	4.7	4.2	3.7	2.9	4.7	4.2	3.7	2.9		4.6	4.1	3.6	2.9	4.6	4.1	3.6	2.9	185
190	4.7	4.1	3.7	2.9	4.7	4.1	3.7	3	4.6	4.1	3.6	2.9		4.6	4.1	3.6	2.9	4.5	4	3.6	2.9	190
195	4.6	4.1	3.6	2.9	4.6	4	3.7	3	4.5	4	3.6	2.9		4.5	4	3.6	2.9	4.4	4	3.6	2.9	195
200	4.5	4	3.6	2.9	4.5	4	3.6	3	4.4	3.9	3.6	2.9		4.4	3.9	3.5	2.9	4.4	3.9	3.5	2.9	200
205	4.5	3.9	3.6	2.9	4.4	3.9	3.6	3	4.4	3.9	3.5	3		4.3	3.9	3.5	3	4.3	3.9	3.5	2.9	205
210	4.4	3.9	3.5	2.9	4.4	3.9	3.5	3	4.3	3.8	3.5	3		4.3	3.8	3.5	3	4.2	3.8	3.5	2.9	210
215	4.3	3.8	3.5	2.9	4.3	3.8	3.5	3.1	4.2	3.8	3.4	3		4.2	3.8	3.4	3	4.1	3.7	3.4	2.9	215
220	4.2	3.8	3.4	2.9	4.2	3.8	3.4	3.1	4.2	3.7	3.4	3		4.1	3.7	3.4	3	4	3.7	3.4	2.9	220
225	4.1	3.7	3.4	2.9	4.1	3.7	3.4	3.1	4.1	3.7	3.4	3		4.1	3.7	3.3	3.1	4	3.6	3.3	2.9	225
230	4.1	3.7	3.4	2.9	4.1	3.7	3.4	3.1	4	3.6	3.4	3.1		4	3.6	3.3	3.1	3.9	3.6	3.3	2.9	230
235	4	3.6	3.4	2.9	4	3.6	3.4	3.1	4	3.6	3.3	3.1		3.9	3.6	3.3	3.1	3.8	3.5	3.3	2.9	235
240	3.9	3.6	3.3	2.9	3.9	3.6	3.3	3.1	3.9	3.5	3.3	3.1		3.9	3.5	3.3	3.1	3.7	3.5	3.3	2.9	240
245	3.8	3.5	3.3	2.9	3.8	3.5	3.3	3.1	3.8	3.5	3.3	3.1		3.8	3.5	3.3	3.1	3.6	3.4	3.2	2.9	245
250	3.8	3.5	3.3	2.9	3.8	3.5	3.3	3.1	3.8	3.4	3.2	3.1		3.8	3.4	3.2	3.1	3.5	3.4	3.2	2.9	250
255	3.7	3.4	3.3	2.9	3.6	3.4	3.2	3.1	3.7	3.4	3.2	3.1		3.7	3.4	3.2	3.1	3.5	3.3	3.2	2.9	255
260	3.5	3.4	3.2	2.9	3.5	3.4	3.2	3.1	3.6	3.4	3.2	3.1		3.6	3.4	3.2	3.1	3.4	3.3	3.2	2.9	260
265	3.4	3.3	3.2	2.9	3.3	3.3	3.2	3.1	3.4	3.3	3.2	3.1		3.5	3.3	3.2	3.1	3.3	3.3	3.2	2.9	265
270	3.3	3.2	3.1	2.9	3.1	3.2	3.1	3.1	3.3	3.2	3.1	3.1		3.3	3.3	3.1	3.1	3.1	3.2	3.1	2.9	270
275	3.2	3.1	3.1	2.9	2.9	3	3.1	3.1	3.1	3.1	3.1	3.1		3.1	3.2	3.1	3.1	2.8	3.1	3.1	2.9	275
280	3.1	3	3	2.9	2.7	2.8	2.9	3.1	2.9	3	3.1	3.1		2.8	3	3.1	3.1	2.5	3	3.1	2.9	280
285	3	3	3	2.9	2.5	2.7	2.8	3	2.7	2.8	2.9	3.1		2.6	2.8	3	3.1	2.1	2.8	3.1	2.9	285
290	2.9	2.9	2.9	2.9	2.3	2.5	2.6	2.9	2.6	2.7	2.8	3		2.3	2.6	2.8	3	1.7	2.4	2.8	2.9	290
295	2.8	2.8	2.8	2.9	2.1	2.3	2.4	2.7	2.3	2.5	2.6	2.9		1.9	2.3	2.6	3		2	2.6	2.9	295
300	2.7	2.7	2.7	2.9			2.2	2.5	2.1	2.3	2.5	2.7		1.6	2	2.3	2.7		1.6	2.2	2.6	300
305	2.4	2.6	2.7	2.9			2	2.3		2.1	2.3	2.5			1.7	2	2.3			1.7	2.2	305
310	2	2.5	2.6	2.8						1.9	2.1	2.3				1.6	2				1.6	310
315	1.6	2.1	2.4	2.5													1.6					315
320		1.7	2	1.9																		320

maxt_268_005_04001_00_000

Lifting heights

Hauteurs de levage

TF

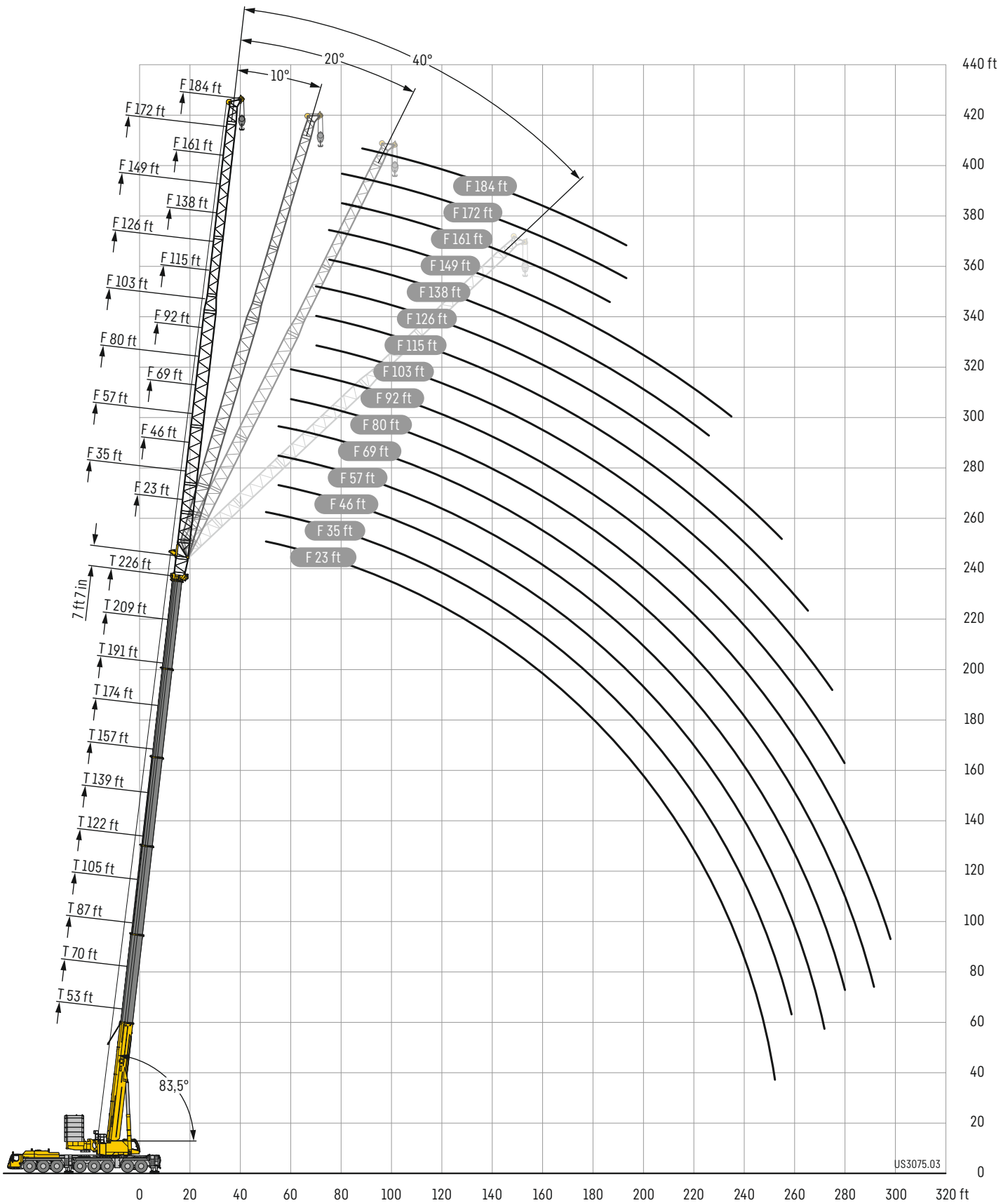

Lifting capacities

Forces de levage

TF 23

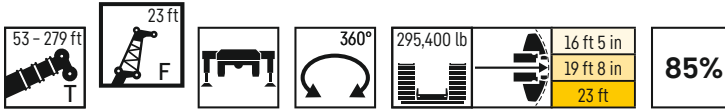

	53 ft + 7 ft 7 in*				122 ft + 7 ft 7 in*				139 ft + 7 ft 7 in*				157 ft + 7 ft 7 in*				
	0°	10°	20°	40°	0°	10°	20°	40°	0°	10°	20°	40°	0°	10°	20°	40°	
11	109.4																11
12	109.4																12
13	109.4																13
14	109.4																14
15	109.4	109.4															15
16	109.4	109.4															16
17	109.4	109.4															17
18	109.4	109.4															18
19	109.4	109.4	109.4														19
20	109.4	109.4	108.6														20
22	109.4	107.7	105		109.4												22
24	109.1	105.5	101.2		109.4				109.4								24
26	106.5	103.2	96.9	83.5	109.4	109.4			109.4								26
28	103.6	100.5	92.6	80.6	109.4	109.4			109.4								28
30	100.7	96.3	88.5	77.9	109.4	109.4	109.4		109.4	109.4			109.4				30
32	97.8	92.1	85.1	75.2	109.4	109.4	109.4		109.4	109.4			109.4				32
34	94.6	87.9	81.8	72.8	109.4	109.4	109.4		109.4	109.4	109.4		109.4	109.3			34
36	91.1	84	78.5	70.5	109.4	109.4	109.4	93.5	109.4	109.4	109.4		109.4	108.8			36
38	87.5	80.6	75.7	68.3	109.4	109.4	109.3	92.3	109.4	109.4	109.4		109.4	108.1			38
40	83.8	77.9	73.2	66.5	109.4	109.4	108.8	91.1	109.4	109.4	109.4	90.7	109.4	107.5	108.4		40
45	74.9	70.9	67.1	61.9	109.4	109.4	107.5	88.4	109.4	109.4	107.9	88.2	106.5	105.9	104.5	86.9	45
50	68.4	64.7	61.9	58.1	109.4	108.9	105.9	85.8	109.4	109.4	104.8	85.8	101.2	101.5	100.3	85	50
55	62.7	60	57.6	54.7	109.4	106.8	101.5	83.5	108.4	109.2	101.6	83.6	95.8	95.7	94.7	83.1	55
60	57.7	55.4	53.8	51.9	109.4	104.8	97.2	81.2	106.4	106.6	98.2	81.7	90.7	89.9	89.2	81.2	60
65	53.7	52.1	50.7	49.6	108.3	102.7	93	79.4	104.5	103.3	94.7	79.8	86	84.8	84.1	79	65
70	49.9	48.8	48.1	47.9	105.3	99.3	89.9	77.6	102.4	100.1	91.1	78.2	81.4	80.5	79.8	76.9	70
75	46.5	46.1	46	30.4	101.8	95.5	86.8	75.8	99.1	96.4	88.1	76.7	76.9	76.2	75.5	74.7	75
80					98.4	91.6	83.7	74.4	93.7	91.9	85.4	75.2	72.4	71.9	71.5	71.5	80
85					95	87.8	80.8	73	88.3	87.1	82.7	73.8	68.7	68.2	67.9	68	85
90					91.5	83.9	78.4	71.6	82.9	82.3	80.1	72.6	65.6	65	64.8	64.5	90
95					86	81.1	76.2	70.5	77.4	77.4	77.3	71.4	62.5	62	61.7	61.3	95
100					79.9	78.6	74	69.5	72.3	72.8	73.6	70.1	59.4	59.1	58.6	58.5	100
105					74.4	75.2	72	68.3	68.6	68.9	69.6	67.5	56.4	56.1	55.5	55.8	105
110					69.4	70.1	70.5	67.7	64.8	65.1	65.6	64.6	53.3	53.2	53	53.1	110
115					64.9	65.4	66	66.4	61.1	61.4	61.6	61.6	50.8	50.6	50.7	50.6	115
120					60.7	61.2	61.6	62	57.4	57.6	58.2	58.5	48.4	48.3	48.3	48.3	120
125					56.7	57.2	57.5	57.8	53.9	54.2	54.9	55.2	46.1	46.1	45.9	46	125
130					53.1	53.5	53.8	53.9	50.3	50.9	51.3	51.8	43.8	43.8	43.6	43.7	130
135					49.8	50.2	50.3		47	47.5	47.9	48.2	41.4	41.5	41.6	41.7	135
140					46.8	47	47.2		43.9	44.4	44.7	44.9	39.3	39.5	39.6	39.7	140
145					42.5	43.9	43.7		41	41.4	41.6	41.7	37.4	37.6	37.6	37.7	145
150									38.3	38.6	38.8		35.6	35.7	35.6	35.8	150
155									35.8	36	36.2		33.7	33.8	33.8	33.9	155
160									33.5	33.6	33.7		31.9	32	32.2	32.2	160
165									20.3				29.8	30.1	30.3		165
170													27.7	28	28.1		170
175													25.8	26	26.1		175
180													20.8	21			180

* adapter - piece d'adaptateur

Lifting capacities

Forces de levage

TF 23

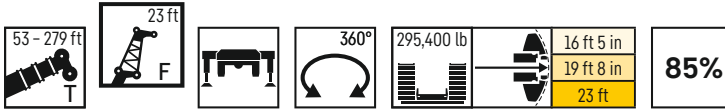

	174 ft + 7 ft 7 in*				191 ft + 7 ft 7 in*				209 ft + 7 ft 7 in*				226 ft + 7 ft 7 in*				
	0°	10°	20°	40°	0°	10°	20°	40°	0°	10°	20°	40°	0°	10°	20°	40°	
34	102.3																34
36	102.5																36
38	99.8				80.6												38
40	97.1	97.5			82.5												40
45	90.7	91.3	92		77.8	78.6			66.7								45
50	85.6	85	86	82.4	73.1	74.1	74.7		63.4	64			54.2				50
55	81.1	80.4	80.2	80.4	68.6	69.6	70.5	67.3	60	60.8	61.6		51.9	51.7			55
60	76.6	76.1	75.8	77.1	65	65.5	66.2	68.3	56.7	57.4	58.3	54.1	49.6	49.7	49.9		60
65	72.1	71.9	71.7	72.1	61.8	61.7	62.3	64.1	53.7	54.3	55.1	57	47.3	47.7	48.1	48.4	65
70	68.2	67.8	67.8	68	58.6	58.6	58.5	60.2	50.8	51.3	52.1	53.9	45.1	45.7	46.3	46.9	70
75	64.9	64.5	64.4	64.7	55.6	55.6	55.5	56.4	48.4	48.5	49.2	50.8	42.8	43.6	44.2	45.2	75
80	61.6	61.4	61.2	61.4	53	52.9	52.8	53.1	46	46	46.3	47.8	40.6	41.4	42	43.1	80
85	58.4	58.2	58	58.4	50.5	50.5	50.4	50.6	43.9	43.7	43.8	45.1	38.4	39.2	39.8	41	85
90	55.1	55.1	54.9	55.7	48	48.1	48	48.3	42	41.8	41.9	42.5	36.8	37	37.6	38.9	90
95	52.6	52.3	52.4	53	45.6	45.7	45.7	46	40.1	40	40.1	40.4	35.4	35.3	35.6	36.9	95
100	50.2	50	50.1	50.3	43.3	43.4	43.5	44	38.3	38.2	38.3	38.6	34	33.9	33.9	34.8	100
105	47.9	47.8	47.7	47.9	41.2	41.4	41.5	42	36.4	36.4	36.5	37	32.5	32.6	32.5	32.9	105
110	45.6	45.5	45.3	45.8	39.5	39.6	39.7	40	34.7	34.7	34.8	35.4	31.1	31.2	31.2	31.7	110
115	43.3	43.3	43	43.7	37.7	37.8	37.9	38.1	33.1	33.1	33.4	33.8	29.7	29.8	29.9	30.4	115
120	41.1	41	40.9	41.6	36	36.1	36.1	36.4	31.7	31.8	31.9	32.3	28.3	28.5	28.6	29.2	120
125	39	39	39.1	39.6	34.2	34.4	34.2	34.8	30.4	30.4	30.6	30.8	27.2	27.3	27.5	27.9	125
130	37.3	37.3	37.3	37.8	32.5	32.7	32.5	33.1	29	29.1	29.2	29.5	26.1	26.2	26.4	26.6	130
135	35.6	35.6	35.6	36	30.8	31	31.1	31.5	27.7	27.7	27.8	28.3	25.1	25.2	25.3	25.5	135
140	33.9	33.9	33.8	34.1	29.4	29.5	29.7	30	26.3	26.4	26.4	27	24	24.1	24.2	24.4	140
145	32.2	32.2	32.2	32.4	28.1	28.2	28.3	28.6	25	25.1	25.2	25.7	23	23.1	23.1	23.4	145
150	30.5	30.5	30.7	31	26.8	26.9	26.9	27.1	23.7	23.8	24.1	24.5	21.9	22.1	22	22.3	150
155	29	29	29.3	29.5	25.5	25.6	25.6	25.7	22.6	22.8	23	23.4	20.9	21	21	21.3	155
160	27.6	27.7	27.9	28.1	24.2	24.2	24.3	24.5	21.6	21.7	21.8	22.2	19.9	20	20.1	20.3	160
165	26.3	26.3	26.5	26.7	22.9	22.9	23.2	23.3	20.5	20.7	20.7	21.1	18.9	19.1	19.2	19.4	165
170	24.9	25	25.2	25.4	21.7	21.9	22.1	22.1	19.5	19.6	19.6	20	18.1	18.2	18.3	18.5	170
175	23.5	23.7	23.9		20.7	20.9	20.9	21	18.4	18.5	18.7	19	17.2	17.3	17.4	17.6	175
180	22.3	22.4	22.6		19.7	19.9	19.8	19.9	17.4	17.5	17.7	18	16.3	16.5	16.5	16.7	180
185	21.2	21.3	21.4		18.8	18.8	18.8	18.9	16.5	16.6	16.8	17	15.5	15.6	15.6	15.8	185
190	20.1	20.2	20.2		17.8	17.8	17.9		15.7	15.8	15.9	16.1	14.6	14.7	14.8	15	190
195	18.2	18.9	18.9		16.8	16.9	17		14.9	15	15	15.2	13.8	13.9	14.1	14.1	195
200					16	16	16.1		14.1	14.2	14.2	14.4	13.1	13.2	13.3	13.3	200
205					15.1	15.1	15.2		13.3	13.4	13.5		12.4	12.6	12.6	12.5	205
210					14.3	14.3	14.3		12.6	12.7	12.8		11.8	11.9	11.8	11.9	210
215					11	11			11.9	12	12		11.3	11.3	11.1	11.2	215
220									11.4	11.4	11.4		10.6	10.7	10.6		220
225									10.8	10.8	10.8		10.1	10.1	10.1		225
230									9.5	9.9	9.8		9.5	9.6	9.6		230
235													9.2	9.2	9.2		235
240													8.8	8.8	8.8		240
245													8.4	8.4	8.4		245
250													5.8	6.1			250

* adapter - piece d'adaptateur

Lifting capacities

Forces de levage

TF 23

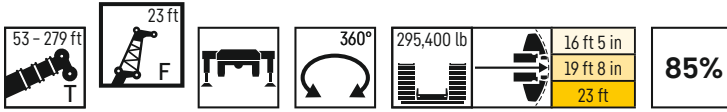

	243 ft + 7 ft 7 in*				259 ft + 7 ft 7 in*				261 ft + 7 ft 7 in*				276 ft + 7 ft 7 in*				279 ft + 7 ft 7 in*						
	0°	10°	20°	40°	0°	10°	20°	40°	0°	10°	20°	40°	0°	10°	20°	40°	0°	10°	20°	40°			
50	40.4																				50		
55	43.8				32.7																	55	
60	42.5	42.1	37.3		31.7	31.6			34.7					28.9								60	
65	41.2	40.8	40.5		30.6	30.5	30.4		33.7	33.5				28	27.8				27.3			65	
70	39.8	39.6	39.3	39.2	29.5	29.5	29.5		32.7	32.5	32.4			27.1	27.1	25.8			26.4	26.5	25.2	70	
75	38.3	38.3	38.1	38.1	28.4	28.4	28.4	28.7	31.7	31.5	31.4	31.6		26.3	26.2	25.1			25.4	25.6	24.6	75	
80	36.6	36.8	36.8	36.9	27.4	27.3	27.4	27.7	30.7	30.5	30.5	30.7		25.4	25.4	24.3	24.6		24.5	24.7	23.9	24.2	80
85	34.9	35.2	35.3	35.8	26.5	26.4	26.4	26.7	29.7	29.6	29.5	29.8		24.5	24.5	23.5	23.8		23.5	23.8	23.2	23.5	85
90	33.3	33.7	33.9	34.8	25.5	25.5	25.5	25.8	28.7	28.7	28.7	28.9		23.7	23.7	22.8	23.1		22.5	22.9	22.4	22.7	90
95	31.6	32.1	32.5	33.7	24.5	24.6	24.6	24.8	27.8	27.9	27.8	28		22.9	22.9	22.2	22.4		21.6	21.9	21.6	22	95
100	30	30.6	31.1	32.3	23.6	23.6	23.7	23.9	26.8	27	27	27.1		22.1	22.1	21.5	21.7		20.6	21	20.8	21.4	100
105	28.5	29.1	29.6	30.6	22.6	22.7	22.8	23.1	25.8	26.1	26.2	26.3		21.2	21.3	20.8	21		19.6	20	19.9	20.7	105
110	27.1	27.6	28.1	29	21.7	21.8	21.9	22.2	24.8	25.1	25.2	25.4		20.4	20.5	20.1	20.3		18.6	19	19.1	19.9	110
115	25.9	26.1	26.6	27.4	20.8	20.9	21	21.4	23.6	24.1	24.1	24.6		19.6	19.7	19.4	19.6		17.6	18.1	18.3	19.1	115
120	24.9	25	25.1	25.9	20	20.1	20.2	20.6	22.4	22.9	23	23.7		18.8	18.9	18.8	19		16.8	17.1	17.5	18.2	120
125	24	24.1	24.1	24.5	19.1	19.2	19.3	19.8	21.2	21.7	21.9	22.7		17.9	18.2	18.1	18.3		15.9	16.3	16.6	17.3	125
130	23	23.2	23.2	23.4	18.2	18.3	18.5	18.9	20.1	20.5	20.8	21.7		17.1	17.4	17.4	17.6		15.1	15.4	15.8	16.4	130
135	22.2	22.3	22.3	22.6	17.3	17.5	17.6	18.1	18.9	19.4	19.7	20.6		16.3	16.7	16.7	17		14.2	14.5	14.9	15.5	135
140	21.3	21.5	21.5	21.8	16.5	16.6	16.9	17.3	17.8	18.2	18.6	19.4		15.5	15.9	16	16.3		13.3	13.7	14.1	14.7	140
145	20.5	20.6	20.6	20.9	15.7	15.9	16.1	16.5	16.8	17.2	17.6	18.2		14.7	15.1	15.3	15.6		12.5	12.8	13.3	13.9	145
150	19.7	19.8	19.8	20.1	15	15.1	15.3	15.6	15.8	16.2	16.6	17.1		13.9	14.4	14.6	15		11.7	12	12.5	13	150
155	18.8	18.9	18.9	19.3	14.2	14.4	14.6	14.9	14.9	15.2	15.6	16		13.1	13.6	13.8	14.3		10.9	11.2	11.8	12.2	155
160	18	18.1	18.1	18.5	13.5	13.6	13.8	14.1	14	14.3	14.6	15		12.3	12.8	13	13.6		10.2	10.5	11	11.4	160
165	17.2	17.3	17.3	17.6	12.8	12.9	13	13.3	13	13.4	13.6	14		11.5	11.9	12.3	12.9		9.5	9.8	10.3	10.6	165
170	16.3	16.4	16.5	16.8	12	12.2	12.3	12.6	12.1	12.4	12.6	13.1		10.8	11.1	11.5	12.1		8.8	9.1	9.6	9.9	170
175	15.5	15.7	15.8	16	11.3	11.5	11.5	11.8	11.2	11.5	11.6	12.1		10	10.3	10.7	11.2		8.1	8.4	8.9	9.2	175
180	14.8	14.9	15	15.2	10.6	10.7	10.9	11.1	10.3	10.5	10.8	11.1		9.2	9.5	9.9	10.4		7.4	7.7	8.2	8.5	180
185	14.2	14.2	14.3	14.4	9.9	10.1	10.3	10.5	9.4	9.7	10	10.3		8.4	8.7	9.2	9.6		6.8	7	7.4	7.8	185
190	13.5	13.6	13.5	13.7	9.3	9.5	9.7	9.8	8.6	8.9	9.2	9.5		7.6	7.9	8.5	8.8		6.1	6.3	6.8	7.1	190
195	12.8	12.9	12.8	12.9	8.7	8.9	9	9.2	7.9	8.1	8.4	8.6		6.8	7.1	7.8	8		5.4	5.6	6.2	6.5	195
200	12.1	12.1	12.1	12.2	8.2	8.3	8.4	8.6	7.2	7.4	7.6	7.8		6.1	6.4	7.1	7.3		4.7	5	5.6	5.8	200
205	11.4	11.5	11.6	11.7	7.6	7.8	7.8	7.9	6.5	6.7	6.8	7		5.5	5.7	6.4	6.6		4.2	4.4	5	5.2	205
210	10.8	10.8	11.1	11.1	7.1	7.2	7.2	7.4	5.8	5.9	6	6.2		4.8	5.1	5.7	5.9		3.6	3.8	4.4	4.6	210
215	10.2	10.3	10.5	10.5	6.5	6.6	6.7	6.8	5.1	5.2	5.4	5.5		4.2	4.5	5	5.2		3	3.2		4	215
220	9.8	9.9	10	10	6	6.1	6.2	6.3		4.5	4.7	4.8		3.6	3.8	4.3	4.5		2.3	2.5		3.4	220
225	9.3	9.4	9.5	9.5	5.5	5.5	5.7	5.8		3.8	4.1	4.1		2.9		3.7	3.8		1.6			2.7	225
230	8.9	9	8.9	9	5	5.1	5.2	5.2		3.3	3.4	3.4				3.1	3.2					1.9	230
235	8.4	8.5	8.5		4.6	4.7	4.7	4.7		2.5		2.7				2.3	2.4						235
240	8	8	8.1		4.1	4.2	4.2	4.3		1.8		1.8				1.6							240
245	7.5	7.6	7.7		3.7	3.8	3.8	3.8															245
250	7.2	7.3	7.3		3.3	3.3	3.4																250
255	6.8	6.9	6.9		2.9	2.9	3																255
260	6.5	6.5	6.5		2.4	2.5	2.6																260
265	4.7	5.2			2	2.1	2.1																265
270					1.7	1.7	1.6																270

* adapter - piece d'adaptateur

Lifting capacities

Forces de levage

TF 35

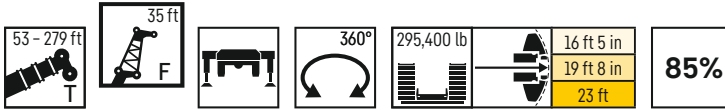

	53 ft + 7 ft 7 in*				122 ft + 7 ft 7 in*				139 ft + 7 ft 7 in*				157 ft + 7 ft 7 in*				
	0°	10°	20°	40°	0°	10°	20°	40°	0°	10°	20°	40°	0°	10°	20°	40°	
14	109.4																14
15	109.4																15
16	109.4																16
17	109.4																17
18	109.4																18
19	109.4																19
20	109.4	109.4															20
22	109.4	109.4															22
24	109.4	109.3			109.4												24
26	109.4	107.2	90.2		109.4												26
28	108.9	103.9	86.7		109.4				109.4								28
30	107.7	100.7	83.3		109.4	109.1			109.4								30
32	106.5	97.4	80.5		109.4	107.3			109.4				109.1				32
34	105.3	94	77.7		109.4	105.4			109.4	104.8			107.7				34
36	104.1	90.6	75	56.3	109.3	103.5	82.2		109.4	102.6			106.3				36
38	102.3	87.1	72.3	55.1	109.2	101.6	81.2		109.4	100.4			104.8				38
40	99.6	83.7	70.2	53.9	109.1	99.6	80.2		108.8	98.2	80.2		103.4	94			40
45	90.7	75.9	65.1	51.3	108.9	94.5	77.5	55.2	106.1	93	77		99.9	90	75.3		45
50	81.8	70.2	60.6	49.1	107.8	89.3	73.9	53.9	103.4	88.8	74	54.1	94.8	86	72.7		50
55	74	64.4	57	47.1	102.9	84.4	70.4	52.5	100.7	84.7	71.1	52.7	89.6	82.3	70.2	52.6	55
60	68	59.6	53.4	45.6	97.5	80.5	67.5	51.1	97.1	80.7	68.3	51.4	84.4	79.2	68	51.4	60
65	62	55.8	50.6	44.2	92.1	76.7	64.7	49.8	92.9	77.5	65.8	50.3	79.4	76.1	65.7	50.4	65
70	57.2	52	48.1	43.3	87.3	72.9	62.1	48.7	88.7	74.5	63.5	49.2	75.5	73	63.5	49.3	70
75	53.1	49.1	45.9	42.6	83.2	69.6	59.8	47.7	84.6	71.5	61.2	48.1	71.8	69.9	61.4	48.4	75
80	49.1	46.4	44.2	42.5	79.4	66.9	57.8	46.8	80.9	68.5	59	47.3	68	66.7	59.6	47.5	80
85	45.9	44.3	43.1	42.5	75.5	64.1	55.9	45.9	77.8	66	57.3	46.5	64.2	63.5	57.7	46.7	85
90	43	42.9			71.7	61.3	53.9	45.1	74.7	63.8	55.7	45.7	61	60.5	55.9	46	90
95					68.1	58.5	52.2	44.5	71.7	61.5	54	45	58.4	57.7	54.3	45.4	95
100					65.2	56.4	50.8	43.8	68.6	59.2	52.4	44.4	55.8	55.3	52.6	44.7	100
105					62.4	54.5	49.4	43.4	65.5	56.9	50.9	43.9	53.2	52.8	51	44.1	105
110					59.7	52.7	48.1	43	62.5	55	49.7	43.3	50.6	50.3	49.3	43.7	110
115					57	50.8	46.9	42.6	59.5	53.5	48.6	43	48	47.9	47.6	43.3	115
120					54.5	49.2	46	42.5	56.5	52	47.5	42.7	45.7	45.5	45.7	42.8	120
125					52.4	47.9	45.1	42.5	53.5	50.4	46.4	42.4	43.6	43.5	43.7	42	125
130					50.5	46.6	44.2	42.4	50.5	48.9	45.4	42.3	41.7	41.7	41.7	40.7	130
135					48.7	45.4	43.5	42.4	47.7	47.2	44.5	42.3	39.8	39.8	39.7	39.3	135
140					46.9	44.1	43.1	42.4	44.8	45	43.6	42.3	37.8	37.9	37.8	38	140
145					44.8	43.5	42.7		41.9	42.6	42.6	42.1	35.9	36	36.1	36.5	145
150					42.2	42.5	42.5		39.2	39.8	40.4	40.7	34.2	34.3	34.6	35	150
155					39.7	39.9	40.1		36.6	37.2	37.7	38	32.6	32.7	33	33.5	155
160									34.3	34.7	35.2		31	31.1	31.4	31.9	160
165									32.1	32.5	32.8		29.4	29.6	29.9	30.3	165
170									30.1	30.3	30.5		27.8	28	28.4	28.8	170
175									23.8	25.1			26.4	26.7	27		175
180													24.7	25.1	25.4		180
185													23	23.3	23.6		185
190													19.9	21.4	21.4		190

* adapter - piece d'adaptateur

Lifting capacities

Forces de levage

TF 35

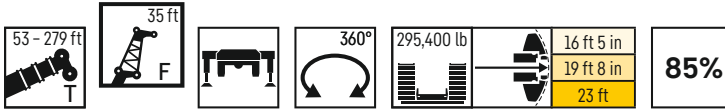

	174 ft + 7 ft 7 in*				191 ft + 7 ft 7 in*				209 ft + 7 ft 7 in*				226 ft + 7 ft 7 in*				
	0°	10°	20°	40°	0°	10°	20°	40°	0°	10°	20°	40°	0°	10°	20°	40°	
38	92.3																38
40	90.1																40
45	84.6	84.3			72.4				57								45
50	79.1	79.6	70.2		68.4	69.1			58.5				48.4				50
55	74.8	74.9	68.2		64.5	65.6	64.3		55.7	56.5			47				55
60	71	70.4	66.1	51.1	60.9	61.9	62		52.9	53.8	54.2		45.4	45.4			60
65	67.3	66.8	63.6	50	57.5	58.3	59.1	49.3	50.2	51.1	51.9		43.7	43.9	43.5		65
70	63.5	63.4	61.4	49.1	54.5	55.1	56.1	48.4	47.7	48.5	49.5	47.1	42	42.4	42.3		70
75	60.3	59.9	59.4	48.2	51.8	51.9	53	47.6	45.1	46	47.1	46.4	40.1	40.8	41	40.4	75
80	57.5	57.1	57.2	47.4	49.1	49.2	49.8	46.9	42.6	43.5	44.7	45.5	38.2	39	39.6	39.4	80
85	54.7	54.4	54.6	46.7	47	46.8	46.7	46	40.6	41	42.3	43.6	36.3	37.1	37.8	38.2	85
90	51.9	51.8	52.1	46	44.9	44.8	44.7	44.4	38.8	38.8	39.9	41.6	34.3	35.2	36	36.9	90
95	49.1	49.2	49.5	45	42.8	42.8	42.8	42.7	37.1	37.2	37.6	39.6	32.5	33.4	34.2	35.5	95
100	46.8	46.5	47.1	44.1	40.7	40.8	40.8	41.1	35.6	35.7	35.8	37.4	31.2	31.6	32.4	34	100
105	44.8	44.6	45.1	43.3	38.7	38.9	38.9	39.5	34	34.1	34.3	35.3	30	29.9	30.7	32.4	105
110	42.8	42.7	43.1	42.4	36.8	37	37.2	37.8	32.4	32.6	32.8	33.2	28.8	28.6	29.1	30.6	110
115	40.9	40.8	41.2	41.2	35.3	35.4	35.6	36.2	30.8	31.1	31.3	31.9	27.6	27.5	27.5	28.8	115
120	38.9	38.9	39.2	39.7	33.8	33.9	34.1	34.6	29.4	29.7	29.9	30.6	26.3	26.4	26.5	27.2	120
125	37	37	37.3	37.9	32.3	32.4	32.5	33	28.2	28.5	28.7	29.3	25.1	25.3	25.5	25.9	125
130	35.1	35.2	35.5	36.1	30.8	31	31	31.6	27	27.3	27.6	28	24.1	24.3	24.5	24.9	130
135	33.4	33.5	34	34.4	29.3	29.5	29.5	30.2	25.8	26.2	26.4	26.7	23.1	23.3	23.6	23.9	135
140	32	32.1	32.4	32.8	27.8	28	28	28.8	24.7	25	25.2	25.6	22.2	22.4	22.6	23	140
145	30.5	30.6	30.9	31.3	26.4	26.7	26.8	27.4	23.5	23.9	24	24.4	21.3	21.5	21.7	22	145
150	29.1	29.2	29.3	29.8	25.2	25.4	25.6	26.1	22.3	22.8	22.9	23.3	20.4	20.6	20.7	21.1	150
155	27.6	27.7	27.9	28.3	24.1	24.3	24.4	24.9	21.2	21.7	21.9	22.2	19.5	19.6	19.8	20.2	155
160	26.2	26.3	26.7	27	22.9	23.1	23.2	23.7	20.1	20.6	20.9	21.2	18.6	18.7	18.8	19.3	160
165	24.9	25	25.5	25.8	21.8	21.9	22	22.4	19.2	19.7	19.9	20.2	17.6	17.8	17.9	18.3	165
170	23.8	23.9	24.2	24.5	20.7	20.8	20.9	21.3	18.3	18.7	18.9	19.2	16.8	16.9	17.1	17.4	170
175	22.6	22.8	23	23.4	19.6	19.6	19.9	20.2	17.3	17.8	17.8	18.1	16	16.1	16.3	16.6	175
180	21.5	21.6	21.9	22.3	18.6	18.7	18.9	19.2	16.4	16.8	16.8	17.1	15.2	15.4	15.5	15.8	180
185	20.3	20.5	20.8	21.2	17.7	17.8	17.9	18.2	15.5	15.9	16	16.2	14.5	14.6	14.7	15	185
190	19.3	19.4	19.7		16.8	16.9	17	17.3	14.5	15	15.2	15.4	13.7	13.8	13.9	14.1	190
195	18.3	18.5	18.6		16	16	16	16.4	13.8	14.2	14.4	14.5	12.9	13.1	13.1	13.3	195
200	17.4	17.5	17.6		15.1	15.1	15.2	15.5	13.1	13.5	13.6	13.7	12.2	12.3	12.5	12.6	200
205	16.5	16.5	16.7		14.2	14.3	14.4		12.5	12.8	12.8	12.9	11.4	11.6	11.9	12	205
210	11.8	12.1			13.5	13.6	13.7		11.8	12.1	12	12.2	10.8	11	11.3	11.3	210
215					12.8	12.8	12.9		11.1	11.3	11.4	11.4	10.4	10.5	10.7	10.7	215
220					12.1	12.1	12.2		10.5	10.7	10.9		9.9	10	10.1	10.1	220
225					9.2	10.2	9.7		10	10.2	10.3		9.4	9.5	9.5	9.6	225
230									9.5	9.7	9.7		8.9	9	9	9.1	230
235									9.1	9.3	9.3		8.4	8.5	8.6		235
240									8.7	8.8	8.8		8	8.1	8.2		240
245									6.7				7.6	7.7	7.7		245
250													7.2	7.3	7.3		250
255													6.9	6.9	6.9		255
260													4.5	4.5			260

* adapter - piece d'adaptateur

Lifting capacities

Forces de levage

TF 35

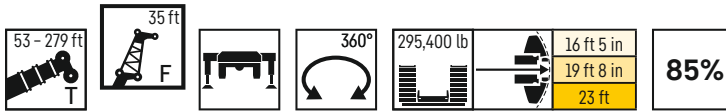

	243 ft + 7 ft 7 in*				259 ft + 7 ft 7 in*				261 ft + 7 ft 7 in*				276 ft + 7 ft 7 in*				279 ft + 7 ft 7 in*				
	0°	10°	20°	40°	0°	10°	20°	40°	0°	10°	20°	40°	0°	10°	20°	40°	0°	10°	20°	40°	
55	39.1																				55
60	38.1				28.4																60
65	36.9	36.4			27.5	26.1															65
70	35.8	35.3	34.9		26.5	25.3															70
75	34.6	34.2	34		25.5	24.5	24.4														75
80	33.3	33.1	33	32.9	24.6	23.7	23.7														80
85	32	32	31.9	32	23.8	23	23	23													85
90	30.7	30.8	30.9	31	22.9	22.2	22.3	22.3													90
95	29.4	29.6	29.9	30.1	22.1	21.5	21.6	21.7													95
100	28	28.5	28.9	29.2	21.3	20.7	20.8	21													100
105	26.7	27.3	27.8	28.3	20.5	20	20.1	20.4													105
110	25.4	26.1	26.8	27.3	19.7	19.2	19.4	19.7													110
115	24.1	24.8	25.5	26.2	18.9	18.5	18.7	19.1													115
120	22.8	23.5	24.2	25.1	18.1	17.8	18	18.4													120
125	21.8	22.2	22.9	23.9	17.3	17.2	17.3	17.7													125
130	21	20.9	21.6	22.7	16.6	16.5	16.7	17.1													130
135	20.3	20.2	20.2	21.5	15.8	15.8	16	16.4													135
140	19.5	19.4	19.5	20.3	15	15.2	15.4	15.8													140
145	18.8	18.7	18.8	19	14.3	14.5	14.7	15.1													145
150	18	18	18.1	18.2	13.5	13.9	14.1	14.5													150
155	17.3	17.3	17.4	17.5	12.9	13.2	13.5	13.8													155
160	16.6	16.6	16.7	16.9	12.2	12.6	12.8	13.2													160
165	15.8	15.9	16	16.2	11.6	12	12.2	12.6													165
170	15.1	15.2	15.3	15.5	10.9	11.3	11.5	11.9													170
175	14.3	14.5	14.7	14.9	10.3	10.7	10.9	11.3													175
180	13.6	13.7	14	14.2	9.6	10.1	10.3	10.7													180
185	12.9	13.1	13.4	13.6	8.9	9.5	9.7	10.1													185
190	12.3	12.5	12.7	12.9	8.3	8.9	9.1	9.4													190
195	11.8	12	12.1	12.2	7.7	8.3	8.5	8.8													195
200	11.2	11.4	11.4	11.6	7.2	7.8	8	8.3													200
205	10.7	10.8	10.8	10.9	6.7	7.2	7.4	7.7													205
210	10.1	10.3	10.2	10.3	6.2	6.7	6.9	7.1													210
215	9.6	9.7	9.7	9.8	5.7	6.2	6.3	6.5													215
220	9	9.1	9.2	9.4	5.2	5.7	5.8	6													220
225	8.5	8.7	8.7	8.9	4.7	5.2	5.3	5.5													225
230	8.1	8.2	8.3	8.4	4.2	4.7	4.8	5													230
235	7.6	7.7	7.8	7.9	3.7	4.2	4.4	4.5													235
240	7.2	7.3	7.3	7.4	3.3	3.8	3.9	4													240
245	6.7	6.8	6.9	6.9	2.9	3.4	3.5	3.5													245
250	6.3	6.3	6.5		2.4	3	3	3.1													250
255	5.8	5.9	6		1.9	2.5	2.5	2.6													255
260	5.5	5.6	5.6			1.9	2														260
265	5.2	5.2	5.2																		265
270	4.8	4.9	4.8																		270
275	4.3	4.5	4.5																		275

* adapter - piece d'adaptateur

Lifting capacities

Forces de levage

TF 46

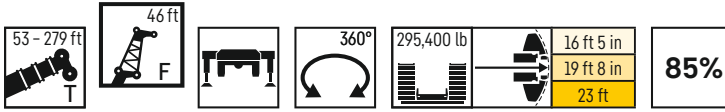

	53 ft + 7 ft 7 in*				122 ft + 7 ft 7 in*				139 ft + 7 ft 7 in*				157 ft + 7 ft 7 in*				
	0°	10°	20°	40°	0°	10°	20°	40°	0°	10°	20°	40°	0°	10°	20°	40°	
15	109.4																15
16	109.4																16
17	109.4																17
18	109.4																18
19	109.4																19
20	109.4																20
22	108.3																22
24	106.2	91.7															24
26	104.1	87.3			108.8												26
28	101.9	82.8			107.6												28
30	99.8	79	63.4		105.9				107.9								30
32	96.3	75.6	61.1		104.6				105.1								32
34	91.9	72.3	58.8		103.2	79.6			102.3				94.7				34
36	87.6	68.9	56.6		101.5	77.7			99.5				92.7				36
38	83.2	65.7	54.8		99.5	75.7			96.7	74.1			90.7				38
40	78.8	63.3	53		96.8	73.8			93.9	72.6			88.7				40
45	69.8	57.6	48.7	37.3	90	69.3	55.7		88.2	68.7	55.2		83.7	66.7			45
50	63.4	52.2	45.3	35.4	83.3	65.7	53		83	65.1	53.5		79.3	63.7	53		50
55	57.1	48.3	42.1	33.7	77.7	62.1	50.5	36.3	77.9	62.2	51.7		75.5	60.8	51.1		55
60	50.9	44.7	39.5	32.2	73.3	58.7	48	35.2	73	59.2	49.6	35.4	71.8	58.4	49.3	35.3	60
65	47.1	41	37.2	30.9	69	56	45.9	34.2	69.5	56.4	47.5	34.5	68	56.1	47.6	34.5	65
70	43.3	38.4	34.9	29.9	64.6	53.3	44.1	33.3	66.1	54.1	45.6	33.6	64.4	53.7	45.9	33.7	70
75	39.6	36	33.1	28.9	61	50.6	42.2	32.5	62.7	51.9	44	32.8	61.9	51.6	44.2	33	75
80	36.9	33.6	31.5	28.2	58	48.2	40.5	31.7	59.4	49.7	42.4	32.1	59.3	49.9	42.8	32.2	80
85	34.4	31.8	30	27.7	55.2	46.2	39.2	31	56.5	47.5	40.7	31.3	56.7	48.2	41.4	31.6	85
90	31.9	30.2	28.9	27.6	52.4	44.3	37.8	30.3	54.3	45.7	39.4	30.8	54.2	46.4	40.1	31	90
95	30	28.7	27.9	27.6	49.5	42.3	36.5	29.7	52	44.1	38.3	30.2	51.9	44.6	38.8	30.4	95
100	28.2	27.6	27.8		46.8	40.4	35.2	29.2	49.7	42.5	37.1	29.6	50.1	43	37.7	29.9	100
105					44.6	38.6	34.1	28.7	47.4	40.9	35.9	29.1	48.2	41.7	36.7	29.5	105
110					42.7	37.3	33.2	28.3	45.2	39.2	34.8	28.7	46.4	40.4	35.7	29	110
115					40.8	36	32.3	28	43.2	37.7	33.8	28.3	44.6	39.1	34.8	28.6	115
120					38.9	34.7	31.4	27.7	41.7	36.5	33	28	42.7	37.8	33.8	28.3	120
125					37	33.4	30.5	27.4	40.1	35.4	32.2	27.7	40.9	36.5	32.8	28	125
130					35.6	32.3	29.8	27.3	38.5	34.4	31.4	27.5	39.2	35.3	32.2	27.6	130
135					34.3	31.5	29.2	27.3	37	33.3	30.7	27.3	37.6	34.4	31.5	27.4	135
140					33.1	30.6	28.5	27.2	35.5	32.2	30.1	27.2	36	33.5	30.9	27.3	140
145					31.8	29.7	28	27.2	34.3	31.4	29.5	27.2	34.4	32.7	30.3	27.2	145
150					30.6	28.9	27.7	27.2	33.2	30.7	29	27.2	32.8	31.8	29.6	27	150
155					29.7	28.4	27.5		32.2	29.9	28.5	27.2	31.1	31	29	27	155
160					28.8	27.9	27.3		31.1	29.2	28.1	27.2	29.7	29.9	28.4	27	160
165					27.9	27.5	27.3		30	28.5	27.9	27.2	28.4	28.6	27.8	27	165
170					24.1	26.8			29.3	28.1	27.7		27	27.3	27.1	27	170
175									28.5	27.8	27.5		25.6	26	26.3	26.3	175
180									27	27.3	27.4		24.3	24.7	25.1	25.2	180
185									22.4	25	24.7		23.1	23.5	23.9		185
190													22	22.4	22.6		190
195													20.5	20.9	21.3		195
200													19	19.4	19.6		200
205													10.4				205

* adapter - piece d'adaptateur

Lifting capacities

Forces de levage

TF 46

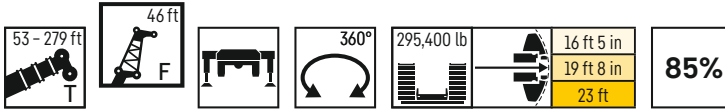

	174 ft + 7 ft 7 in*				191 ft + 7 ft 7 in*				209 ft + 7 ft 7 in*				226 ft + 7 ft 7 in*				
	0°	10°	20°	40°	0°	10°	20°	40°	0°	10°	20°	40°	0°	10°	20°	40°	
40	81.4																40
45	77.5				66.8												45
50	73.7	60.9			63.5				53.2								50
55	69.8	58.6	49.7		60.2	55			51.1				42.8				55
60	65.9	56.3	48.2		56.9	53.3	46.3		48.9	49.5			41.4				60
65	62.6	54.4	46.7	34.3	54	51.6	45.1		46.8	47.5			40.1	39.6			65
70	59.4	52.6	45.3	33.6	51.1	49.7	43.9	33.1	44.6	45.5	41.8		38.7	38.5	28.1		70
75	56.3	50.8	43.9	32.9	48.2	47.6	42.7	32.5	42.5	43.5	40.9		37.3	37.3	36.6		75
80	53.7	48.9	42.6	32.2	45.8	45.5	41.6	31.9	40.3	41.5	39.9	31.3	35.6	36.1	35.5		80
85	51.3	46.9	41.3	31.5	43.6	43.6	40.5	31.3	38.1	39.4	38.6	30.8	33.9	34.7	34.4	30	85
90	48.9	45.6	40.2	31	41.8	41.6	39.4	30.8	36	37.3	37.1	30.3	32.3	33.1	33.2	29.6	90
95	46.6	44.2	39.1	30.5	40	39.9	38.1	30.3	34.5	35.2	35.7	29.8	30.6	31.5	31.9	29.2	95
100	44.2	42.8	37.9	30	38.1	38.2	36.6	29.8	33.1	33.2	34.2	29.4	29	30	30.6	28.8	100
105	42.2	41.4	36.8	29.5	36.4	36.6	35.5	29.4	31.7	31.8	32.5	29	27.5	28.4	29.2	28.5	105
110	40.3	40	35.7	29.1	34.6	34.9	34.4	28.9	30.3	30.5	30.8	28.7	26.2	27	27.9	28.1	110
115	38.6	38.4	34.9	28.8	32.9	33.3	33.2	28.5	28.9	29.1	29.3	28.3	25.2	25.5	26.5	27.2	115
120	36.9	36.8	34.1	28.4	31.6	31.9	32	28.2	27.6	27.8	28	27.9	24.2	24.2	25.1	26.1	120
125	35.3	35.2	33.3	28	30.2	30.6	30.8	27.9	26.3	26.6	26.8	27	23.2	23.3	23.7	25	125
130	33.6	33.7	32.6	27.7	28.9	29.3	29.5	27.6	25.2	25.4	25.7	26	22.2	22.4	22.5	23.8	130
135	31.9	32.1	31.7	27.5	27.6	28	28.2	27.2	24.2	24.4	24.7	25	21.3	21.5	21.7	22.5	135
140	30.3	30.5	30.7	27.3	26.3	26.8	27	26.4	23.2	23.4	23.7	24	20.4	20.7	20.9	21.2	140
145	29	29.1	29.4	27	25	25.5	25.7	25.5	22.2	22.4	22.6	23	19.6	19.9	20.1	20.3	145
150	27.7	27.9	28.1	26.4	23.6	24.3	24.5	24.5	21.2	21.4	21.6	22	18.8	19.1	19.3	19.6	150
155	26.4	26.6	26.8	25.8	22.5	23.1	23.4	23.6	20.2	20.4	20.6	21.1	18	18.2	18.4	18.8	155
160	25.2	25.4	25.5	25.1	21.5	22	22.3	22.6	19.1	19.4	19.6	20.1	17.2	17.4	17.6	18	160
165	23.9	24.1	24.3	24.5	20.5	21	21.2	21.6	18.2	18.5	18.7	19.1	16.4	16.6	16.8	17.2	165
170	22.7	22.9	23.2	23.5	19.5	20	20.1	20.5	17.3	17.6	17.8	18.2	15.6	15.8	16	16.4	170
175	21.6	21.8	22.1	22.4	18.5	18.9	19	19.4	16.5	16.7	16.9	17.3	14.8	15	15.2	15.6	175
180	20.6	20.8	21.1	21.3	17.5	17.9	18	18.4	15.6	15.9	16	16.4	14	14.3	14.5	14.8	180
185	19.6	19.8	20	20.3	16.5	16.9	17.1	17.5	14.8	15	15.2	15.5	13.4	13.6	13.8	14	185
190	18.6	18.8	19	19.3	15.7	16	16.3	16.5	14	14.2	14.3	14.7	12.8	13	13.1	13.3	190
195	17.7	17.9	18.1	18.3	14.9	15.2	15.4	15.6	13.1	13.3	13.6	13.8	12.1	12.3	12.4	12.6	195
200	16.7	16.9	17.2		14.1	14.5	14.6	14.8	12.3	12.5	12.9	13.1	11.5	11.7	11.7	11.9	200
205	15.8	16	16.3		13.4	13.7	13.7	13.9	11.7	11.9	12.2	12.3	10.9	11.1	11	11.2	205
210	15	15.2	15.4		12.6	12.9	13	13.2	11.2	11.3	11.5	11.5	10.2	10.4	10.4	10.6	210
215	14.2	14.3	14.5		11.9	12.2	12.3		10.6	10.7	10.8	10.8	9.6	9.8	9.9	10.1	215
220	10.1	10.7			11.2	11.5	11.6		10.1	10.2	10.2	10.3	9.1	9.3	9.4	9.6	220
225					10.7	10.9	10.9		9.5	9.6	9.7	9.7	8.6	8.8	8.9	9.1	225
230					10.2	10.3	10.4		9	9.1	9.2		8.1	8.3	8.4	8.6	230
235					9	9.8	9.8		8.5	8.6	8.7		7.7	7.8	7.9	8.1	235
240									8.1	8.2	8.2		7.2	7.3	7.5	7.6	240
245									7.7	7.8	7.8		6.7	6.8	7		245
250									7.2	7.4	7.3		6.2	6.4	6.5		250
255									5.4	5.5			5.9	6	6.1		255
260													5.5	5.6	5.6		260
265													5.2	5.2	5.3		265
270													3.5	4.5	4.2		270

* adapter - piece d'adaptateur

Lifting capacities

Forces de levage

TF 46

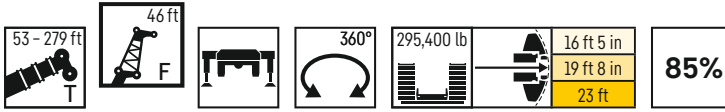

	243 ft + 7 ft 7 in*				259 ft + 7 ft 7 in*				261 ft + 7 ft 7 in*				276 ft + 7 ft 7 in*				279 ft + 7 ft 7 in*				
	0°	10°	20°	40°	0°	10°	20°	40°	0°	10°	20°	40°	0°	10°	20°	40°	0°	10°	20°	40°	
60	34				24.2				26.4				21.4				21				60
65	33				23.5				25.8												65
70	32	31.5			22.8	22.5			25.1	24.7			20.8				20.4				70
75	31	30.6	25.5		22.1	21.9			24.4	24.2			20.2	20			19.8				75
80	30	29.7	29.4		21.4	21.3	21.1		23.7	23.5	23.3		19.6	19.6			19.2	19.2			80
85	29	28.7	28.6		20.7	20.6	20.5		23	22.8	22.7		19	19	19		18.6	18.7			85
90	27.9	27.8	27.7	27.1	20	20	19.9		22.3	22.2	22.1		18.4	18.4	18.5		18	18.1	18.1		90
95	26.9	26.9	26.9	26.3	19.3	19.3	19.3	19.4	21.7	21.5	21.5	21.2	17.8	17.8	17.9		17.4	17.5	17.6		95
100	25.8	26	26.1	25.6	18.7	18.7	18.6	18.8	21.1	20.9	20.9	20.7	17.2	17.2	17.4	17.6	16.7	17	17.1	17.3	100
105	24.7	25.1	25.3	24.8	18	18.1	18.1	18.3	20.5	20.3	20.3	20.1	16.7	16.7	16.9	17.2	16	16.3	16.5	17	105
110	23.6	24.2	24.5	24.1	17.3	17.4	17.5	17.7	19.9	19.7	19.8	19.6	16.1	16.2	16.3	16.7	15.3	15.7	16	16.5	110
115	22.5	23.2	23.7	23.4	16.6	16.8	16.9	17.2	19.2	19.2	19.2	19.1	15.6	15.7	15.8	16.2	14.6	15.1	15.4	16	115
120	21.4	22.2	22.8	22.8	16	16.1	16.3	16.6	18.6	18.6	18.6	18.6	15	15.1	15.3	15.7	13.9	14.4	14.8	15.5	120
125	20.2	21.1	21.7	22.1	15.4	15.5	15.7	16.1	17.8	18	18	18.1	14.5	14.6	14.7	15.2	13.2	13.8	14.3	15	125
130	19.1	19.9	20.6	21.4	14.8	14.9	15.1	15.5	17	17.3	17.4	17.5	13.9	14.1	14.2	14.7	12.5	13.1	13.7	14.5	130
135	18.1	18.8	19.5	20.7	14.1	14.3	14.6	14.9	16.2	16.6	16.8	17	13.3	13.5	13.7	14.2	11.8	12.5	13	13.9	135
140	17.4	17.7	18.4	19.9	13.5	13.7	14	14.4	15.4	15.8	16.2	16.5	12.8	13	13.2	13.7	11.2	11.8	12.4	13.3	140
145	16.8	16.8	17.3	18.9	12.9	13.2	13.4	13.8	14.7	15.1	15.6	16	12.2	12.5	12.7	13.2	10.5	11.1	11.7	12.6	145
150	16.1	16.1	16.3	17.9	12.3	12.6	12.9	13.3	13.9	14.4	15	15.4	11.7	12	12.2	12.7	9.9	10.4	11	11.9	150
155	15.5	15.5	15.4	16.8	11.7	12	12.3	12.7	13.1	13.7	14.4	14.8	11.1	11.4	11.7	12.2	9.2	9.8	10.3	11.2	155
160	14.9	14.9	14.8	15.7	11.1	11.4	11.7	12.2	12.4	13	13.7	14.1	10.5	10.9	11.2	11.7	8.5	9.1	9.6	10.5	160
165	14.2	14.3	14.2	14.7	10.5	10.9	11.1	11.6	11.6	12.2	12.9	13.4	10	10.4	10.6	11.2	7.8	8.4	9	9.9	165
170	13.6	13.7	13.7	13.7	10	10.3	10.6	11.1	10.9	11.5	12.1	12.7	9.3	9.8	10	10.7	7.3	7.8	8.3	9.2	170
175	13	13.1	13.1	13.2	9.4	9.7	10	10.5	10.1	10.7	11.3	12	8.7	9.2	9.4	10.2	6.7	7.2	7.7	8.5	175
180	12.4	12.5	12.6	12.7	8.8	9.2	9.4	10	9.4	9.9	10.5	11.3	8	8.6	8.8	9.7	6.1	6.6	7.1	7.8	180
185	11.7	11.9	12	12.2	8.3	8.6	8.9	9.4	8.6	9.2	9.7	10.5	7.4	7.9	8.1	9.2	5.6	6	6.5	7.1	185
190	11.1	11.4	11.5	11.7	7.7	8	8.3	8.8	7.8	8.4	8.9	9.6	6.8	7.2	7.5	8.5	5	5.4	5.9	6.5	190
195	10.6	10.8	11	11.2	7.2	7.5	7.7	8.3	7.1	7.7	8	8.8	6.1	6.6	6.9	7.8	4.4	4.9	5.3	5.9	195
200	10.1	10.3	10.6	10.7	6.6	6.9	7.2	7.7	6.3	6.9	7.4	8	5.5		6.3	7.1	3.8	4.3		5.3	200
205	9.6	9.8	10.1	10.3	6.1	6.4	6.7	7.2	5.7	6.2	6.7	7.2			5.6	6.4					205
210	9	9.3	9.6	9.8	5.6	5.9	6.2	6.6	5.1	5.6	6	6.5			5	5.7					210
215	8.5	8.8	9.1	9.3	5.2	5.5	5.7	6.1	4.5	4.9	5.3	5.8			4.4	5					215
220	8.1	8.3	8.6	8.9	4.7	5	5.2	5.6	3.9	4.3		5.1			3.8	4.3					220
225	7.5	7.8	8.2	8.4	4.3	4.5	4.7	5	3.3	3.7		4.4			3.1	3.7					225
230	7	7.3	7.7	7.9	3.8	4.1	4.2	4.5	2.4	3		3.7				2.9					230
235	6.6	6.8	7.2	7.4		3.6	3.8	4				2.9									235
240	6.2	6.4	6.8	6.9		3.1	3.3	3.5				2.1									240
245	5.8	6	6.3	6.4		2.6	2.9	3													245
250	5.4	5.5	5.9	6		2.1	2.3	2.4													250
255	5	5.1	5.4	5.5			1.7	1.8													255
260	4.6	4.7	5																		260
265	4.2	4.3	4.6																		265
270	3.8	3.9	4.2																		270
275	3.6	3.6	3.8																		275
280	3.3	3.3	3.5																		280
285	3	3	3.1																		285

* adapter - piece d'adaptateur

Lifting capacities

Forces de levage

TF 57

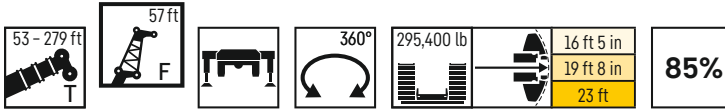

	53 ft + 7 ft 7 in*				122 ft + 7 ft 7 in*				139 ft + 7 ft 7 in*				157 ft + 7 ft 7 in*				
	0°	10°	20°	40°	0°	10°	20°	40°	0°	10°	20°	40°	0°	10°	20°	40°	
17	109.4																17
18	109.4																18
19	109.4																19
20	109.4																20
22	109.4																22
24	108.4																24
26	104.9																26
28	100.6	85.4			103.3												28
30	96.3	82			100.7												30
32	92	78.6			97.9				92.9								32
34	87.8	75.4			95.2				90.9								34
36	84.2	72.6	63.6		92.4				88.8				82.4				36
38	81.1	70	61.7		89.7	74			86.7				80.9				38
40	78	67.3	59.7		87.1	72.6			84.6				79.4				40
45	70.3	61.1	55.1		82.2	68.7			79.8	67.2			75.9				45
50	63.7	56.5	51		77.4	65.1	55		75.8	64			72.4	61.8			50
55	58.9	51.9	47.5	40.4	72.5	62.1	54.1		72	61.1	53.8		69.4	59.4			55
60	54.1	48.3	44.4	38.5	68.6	59.1	52.3		68.2	58.7	51.9		66.6	57	50.9		60
65	49.3	45.2	41.5	36.6	65.3	56.2	50	39.4	64.7	56.2	50		63.8	55	49.2		65
70	45.7	42.1	39.3	34.9	62	53.8	47.7	38.1	62.1	53.8	48.1	38.1	60.9	53.1	47.6		70
75	42.8	39.3	37.1	33.4	58.7	51.5	45.9	36.9	59.5	51.7	46.2	37	58.5	51.2	46.1	36.9	75
80	39.9	37.1	35	32.1	55.8	49.2	44.1	35.9	56.9	49.9	44.6	36	56.5	49.4	44.5	36	80
85	37.1	35.1	33.4	31	53.4	46.9	42.3	34.9	54.3	48	43.1	35.1	54.5	47.8	43	35.2	85
90	35.1	33	31.8	29.9	51.2	45.2	40.7	34	52	46.1	41.6	34.3	52.5	46.3	41.8	34.3	90
95	33.2	31.5	30.3	29.2	48.9	43.5	39.4	33.2	50.1	44.4	40.1	33.4	50.5	44.8	40.5	33.6	95
100	31.2	30	29.3	28.6	46.6	41.8	38.1	32.4	48.3	42.9	38.9	32.7	48.6	43.3	39.3	32.9	100
105	29.8	28.8	28.3	28.6	44.3	40.1	36.8	31.7	46.4	41.5	37.8	32.1	46.8	41.7	38	32.2	105
110	28.3	27.9	28		42.4	38.4	35.6	31	44.6	40.1	36.7	31.4	45	40.5	37	31.6	110
115					40.8	37	34.5	30.4	42.8	38.7	35.6	30.8	43.2	39.3	36.1	31.1	115
120					39.3	35.9	33.6	29.9	40.9	37.3	34.6	30.3	41.4	38.2	35.2	30.5	120
125					37.8	34.8	32.6	29.4	39.6	36.1	33.6	29.8	39.6	37	34.3	30	125
130					36.3	33.7	31.7	29	38.4	35	32.9	29.4	37.8	35.9	33.4	29.6	130
135					34.9	32.5	30.9	28.6	37.1	34.1	32.1	29	36.2	34.8	32.5	29.2	135
140					33.7	31.6	30.2	28.3	35.9	33.2	31.3	28.7	34.7	33.6	31.8	28.9	140
145					32.7	30.8	29.6	28.1	34.6	32.3	30.6	28.3	33.3	32.4	31.1	28.5	145
150					31.7	30	29	28	33.4	31.3	29.9	28	31.9	31.2	30.4	28.2	150
155					30.6	29.3	28.4	27.9	32.5	30.6	29.5	27.9	30.5	30	29.7	28	155
160					29.6	28.5	28.1	27.9	31.6	29.9	29	27.9	29.1	28.8	29	27.8	160
165					28.9	28	27.8		30.8	29.3	28.5	27.8	27.7	27.6	28	27.4	165
170					28.3	27.7	27.5		30	28.7	28	27.8	26.4	26.5	26.9	26.6	170
175					27.6	27.3	27.5		29.1	28.1	27.8	27.8	25.3	25.4	25.8	25.8	175
180					26.4	27.2			28	27.5	27.6		24.1	24.2	24.7	24.9	180
185									26.3	27	27.3		22.9	23.1	23.6	23.8	185
190									24.7	25.2	25.6		21.8	22	22.5	22.8	190
195									22.5	23.6	23.8		20.7	21	21.5		195
200													19.8	20	20.4		200
205													18.7	19.1	19.3		205
210													17.5	17.8	18		210
215													12.3	12.4			215

* adapter - piece d'adaptateur

Lifting capacities

Forces de levage

TF 57

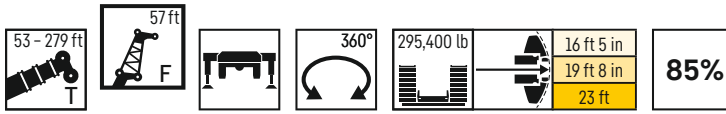

	174 ft + 7 ft 7 in*				191 ft + 7 ft 7 in*				209 ft + 7 ft 7 in*				226 ft + 7 ft 7 in*				
	0°	10°	20°	40°	0°	10°	20°	40°	0°	10°	20°	40°	0°	10°	20°	40°	
45	70.4				50												45
50	67.8				59.3					44.6							50
55	65.1	56.5			56.5					47.4				39			55
60	62.2	54.6			53.6	51.8				45.6				38			60
65	59	52.8	47.6		50.9	50.3				43.9	44			36.9			65
70	55.8	51.1	46.2		48.4	48.9	44.2			42.1	42.6			35.8	34.8		70
75	53.1	49.6	44.9		45.9	47.3	43.1			40.2	41	40.3		34.7	33.9		75
80	50.5	48.1	43.7	35.6	43.4	45.1	42.1			38.4	39.5	39.3		33.4	32.9	32.3	80
85	48.2	46.6	42.5	34.8	41.1	42.8	40.9	34.1		36.5	37.8	38.2		32	31.9	31.4	85
90	46.2	44.9	41.3	34.1	39.2	40.5	39.6	33.5		34.6	36	37	32.4	30.6	30.8	30.4	90
95	44.1	43	40	33.4	37.6	38.2	38.4	32.8		32.7	34.1	35.3	31.9	29.1	29.5	29.5	95
100	42.1	41.4	38.8	32.8	36	36.1	37.1	32.2		31.1	32.3	33.6	31.3	27.7	28.3	28.5	100
105	40	39.8	37.7	32.2	34.5	34.6	35.5	31.7		29.8	30.6	31.9	30.9	26.3	27.1	27.6	105
110	38.2	38.2	36.7	31.6	32.9	33.2	33.6	31.2		28.6	29	30.2	30.5	25	25.9	26.6	110
115	36.6	36.6	35.7	31	31.4	31.8	32	30.7		27.5	27.5	28.6	29.8	23.7	24.7	25.6	115
120	35.1	35.1	34.5	30.6	29.8	30.3	30.6	30.1		26.3	26.3	27.1	28.7	22.5	23.5	24.5	120
125	33.7	33.7	33.4	30.1	28.6	29	29.3	29.3		25.1	25.3	25.6	27.4	21.7	22.2	23.3	125
130	32.2	32.4	32.2	29.7	27.5	27.8	28.1	28.3		23.9	24.2	24.4	26	20.9	21	22.1	130
135	30.7	31	30.9	29	26.3	26.7	27	27.3		23	23.1	23.5	24.7	20.1	20.1	20.8	135
140	29.3	29.6	29.7	28.4	25.2	25.6	25.9	26.3		22	22.2	22.5	23.3	19.3	19.4	19.6	140
145	27.8	28.2	28.6	27.7	24	24.5	24.8	25.3		21.1	21.3	21.6	22	18.5	18.7	18.7	145
150	26.6	26.9	27.4	27	22.9	23.5	23.7	24.2		20.2	20.4	20.8	21.2	17.8	18	18	150
155	25.5	25.7	26.2	26.3	21.8	22.4	22.7	23.2		19.4	19.6	19.9	20.4	17	17.3	17.3	155
160	24.3	24.6	25	25.3	20.7	21.3	21.6	22.1		18.5	18.7	19	19.5	16.3	16.5	16.6	160
165	23.2	23.4	23.8	24.2	19.7	20.3	20.6	21		17.5	17.8	18.1	18.6	15.6	15.8	16	165
170	22.1	22.3	22.6	23.1	18.8	19.4	19.6	20		16.7	17	17.2	17.7	14.9	15.1	15.3	170
175	21	21.2	21.5	22	17.9	18.5	18.7	19		15.8	16.1	16.4	16.8	14.1	14.4	14.6	175
180	19.9	20.1	20.6	20.9	17	17.5	17.7	18.1		15.1	15.3	15.6	16	13.4	13.6	13.9	180
185	19	19.1	19.6	20	16.1	16.6	16.7	17.2		14.4	14.6	14.8	15.1	12.7	12.9	13.2	185
190	18.1	18.3	18.7	19	15.2	15.7	15.8	16.2		13.6	13.9	14	14.4	12.1	12.3	12.7	190
195	17.3	17.5	17.8	18	14.3	14.8	15.1	15.4		12.9	13.1	13.3	13.6	11.5	11.7	12.1	195
200	16.4	16.6	16.9	17.2	13.6	14.1	14.3	14.6		12.2	12.4	12.5	12.8	11	11.1	11.5	200
205	15.6	15.8	16.1	16.3	12.9	13.4	13.5	13.8		11.4	11.7	11.8	12.1	10.4	10.6	10.9	205
210	14.8	15	15.3		12.3	12.7	12.8	13		10.7	11	11.3	11.5	9.9	10.1	10.3	210
215	14	14.2	14.5		11.6	12	12	12.3		10.1	10.4	10.7	10.9	9.3	9.5	9.7	215
220	13.3	13.4	13.7		11	11.3	11.4	11.5		9.7	9.9	10.2	10.3	8.8	9	9.2	220
225	12.5	12.6	12.9		10.4	10.7	10.9			9.2	9.4	9.6	9.7	8.2	8.5	8.7	225
230	9.9	11.5	11.4		9.8	10.1	10.3			8.8	9	9.1	9.2	7.7	8	8.2	230
235					9.4	9.6	9.8			8.3	8.5	8.6	8.7	7.3	7.5	7.7	235
240					9	9.2	9.3			7.8	8	8.1		6.9	7.1	7.2	240
245					8.5	8.7	8.7			7.4	7.6	7.7		6.4	6.6	6.8	245
250					6.5	5.6				7	7.1	7.2		6	6.2	6.3	250
255										6.6	6.7	6.8		5.6	5.7	5.9	255
260										6.2	6.3	6.3		5.1	5.3	5.4	260
265										4.3	4.8			4.8	4.9	5	265
270														4.5	4.6	4.6	270
275														4.2	4.2	4.2	275
280														3.5	3.9	3.9	280

* adapter - piece d'adaptateur

Lifting capacities

Forces de levage

TF 57

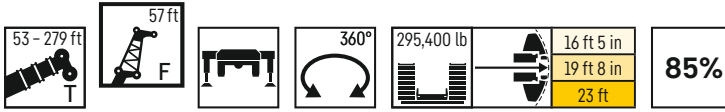

	243 ft + 7 ft 7 in*				259 ft + 7 ft 7 in*				261 ft + 7 ft 7 in*				276 ft + 7 ft 7 in*				279 ft + 7 ft 7 in*				
	0°	10°	20°	40°	0°	10°	20°	40°	0°	10°	20°	40°	0°	10°	20°	40°	0°	10°	20°	40°	
60	30.8				21.4				23.5												60
65	30																				65
70	29.1	24.2			20.8				22.9				18.9				18.5				70
75	28.3	27.8			20.2	19.8			22.3				18.4				18.1				75
80	27.4	27			19.6	19.4			21.7	21.4			17.9				17.5				80
85	26.5	26.2	25.4		19	18.8			21	20.9			17.4	17.3			17	17			85
90	25.7	25.4	24.7		18.4	18.2	18.2		20.4	20.3	19.9		16.8	16.8			16.5	16.5			90
95	24.8	24.6	24		17.8	17.7	17.6		19.9	19.7	19.5		16.3	16.3	16.3		16	16.1	16		95
100	24	23.9	23.3	23.5	17.2	17.1	17.1		19.3	19.2	19		15.8	15.9	15.9		15.4	15.6	15.6		100
105	23.1	23.2	22.7	22.9	16.6	16.6	16.6	16.1	18.8	18.6	18.5	17.8	15.3	15.4	15.5		14.8	15.1	15.2		105
110	22.3	22.5	22.1	22.3	16	16	16.1	15.7	18.2	18.1	18.1	17.4	14.8	14.9	15.1	15	14.2	14.6	14.8		110
115	21.4	21.8	21.4	21.7	15.4	15.5	15.6	15.2	17.7	17.6	17.6	16.9	14.3	14.4	14.6	14.6	13.6	14	14.4	14.5	115
120	20.4	21.1	20.8	21	14.8	14.9	15.1	14.7	17.1	17.1	17.1	16.4	13.8	13.9	14.1	14.2	13	13.5	13.9	14.1	120
125	19.4	20.4	20.1	20.4	14.3	14.4	14.5	14.3	16.5	16.5	16.6	15.9	13.3	13.5	13.7	13.8	12.4	12.9	13.4	13.7	125
130	18.4	19.3	19.4	19.8	13.7	13.9	14.1	13.9	15.8	16	16.1	15.5	12.8	13	13.2	13.4	11.8	12.4	12.9	13.3	130
135	17.4	18.3	18.6	19.2	13.2	13.4	13.6	13.5	15.2	15.4	15.6	15.1	12.3	12.5	12.7	13	11.2	11.8	12.4	12.9	135
140	16.3	17.3	17.8	18.6	12.6	12.8	13.1	13	14.5	14.8	15.1	14.7	11.8	12.1	12.3	12.6	10.6	11.2	11.8	12.5	140
145	15.4	16.3	17.1	17.9	12.1	12.3	12.6	12.6	13.9	14.3	14.6	14.3	11.4	11.6	11.8	12.2	10	10.6	11.3	12	145
150	14.8	15.3	16.3	17.2	11.5	11.8	12.1	12.1	13.2	13.7	14.1	13.9	10.9	11.1	11.4	11.8	9.3	10	10.7	11.5	150
155	14.3	14.3	15.5	16.5	11	11.3	11.6	11.7	12.5	13.1	13.6	13.5	10.4	10.7	10.9	11.4	8.7	9.4	10	11	155
160	13.8	13.7	14.6	15.6	10.4	10.8	11.1	11.3	11.9	12.5	13.1	13.1	9.8	10.2	10.5	11	8.1	8.8	9.4	10.4	160
165	13.3	13.2	13.8	14.8	9.9	10.2	10.6	10.8	11.2	11.8	12.6	12.6	9.3	9.7	10	10.6	7.5	8.2	8.8	9.9	165
170	12.8	12.7	12.9	13.9	9.4	9.7	10.1	10.4	10.5	11.2	12	12.1	8.8	9.3	9.6	10.2	6.9	7.5	8.1	9.3	170
175	12.3	12.3	12.2	13.1	8.9	9.2	9.6	10	9.8	10.6	11.3	11.6	8.3	8.8	9.1	9.7	6.3	6.9	7.5	8.6	175
180	11.7	11.8	11.7	12.2	8.3	8.7	9.1	9.5	9.1	9.8	10.5	11.1	7.7	8.3	8.6	9.3	5.8	6.3	6.9	8	180
185	11.2	11.4	11.3	11.4	7.8	8.2	8.6	9.1	8.4	9.1	9.8	10.6	7.1	7.7	8	8.8	5.3	5.8	6.4	7.4	185
190	10.7	10.9	10.8	11	7.3	7.7	8.1	8.6	7.7	8.4	9.1	10	6.5	7.1	7.4	8.4	4.7	5.3	5.8	6.7	190
195	10.2	10.4	10.3	10.6	6.8	7.2	7.6	8.1	7.1	7.7	8.3	9.3	5.9	6.5	6.8	7.9	4.2	4.8	5.3	6.1	195
200	9.7	10	9.9	10.2	6.3	6.7	7.1	7.6	6.4	7	7.6	8.6	5.3	5.9	6.3	7.3	3.7	4.2	4.7	5.5	200
205	9.3	9.5	9.5	9.8	5.8	6.2	6.5	7.1	5.7	6.3	6.9	7.8	4.8	5.3	5.7	6.8	3	3.7	4.2	4.9	205
210	8.8	9.1	9.1	9.4	5.3	5.7	6.1	6.6	5	5.7	6.2	7			5.1	6.1	2.3			4.3	210
215	8.4	8.6	8.7	9	4.9	5.2	5.6	6.1	4.4	5	5.6	6.3			4.6	5.4				3.8	215
220	7.9	8.2	8.2	8.6	4.4	4.8	5.1	5.6	3.8	4.4	4.9	5.6			4	4.7					220
225	7.5	7.7	7.8	8.2	4	4.4	4.7	5.1	3.3	3.8	4.3	4.9			3.4	4.1					225
230	7	7.3	7.4	7.7	3.6	3.9	4.2	4.6	2.6	3.2		4.2			2.8	3.4					230
235	6.6	6.8	7	7.3	3.2	3.5	3.7	4.1	1.8	2.5		3.6			2.1	2.7					235
240	6.1	6.4	6.5	6.8	2.7	3	3.3	3.6								1.9					240
245	5.7	5.9	6.1	6.4	2.1	2.5	2.8	3.1													245
250	5.4	5.5	5.7	5.9			2.2	2.5													250
255	5	5.2	5.3	5.4			1.7	1.9													255
260	4.6	4.8	4.9	5																	260
265	4.2	4.4	4.5	4.5																	265
270	3.8	4	4.1																		270
275	3.5	3.6	3.7																		275
280	3.1	3.2	3.3																		280
285	2.9	2.9	2.9																		285
290	2.6	2.6	2.6																		290
295	2.3	2.3	2.3																		295

* adapter - piece d'adaptateur

Lifting capacities

Forces de levage

TF 69

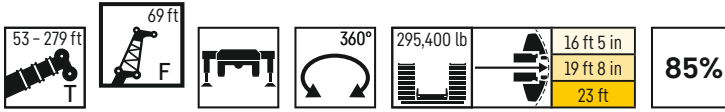

	53 ft + 7 ft 7 in*				122 ft + 7 ft 7 in*				139 ft + 7 ft 7 in*				157 ft + 7 ft 7 in*				
	0°	10°	20°	40°	0°	10°	20°	40°	0°	10°	20°	40°	0°	10°	20°	40°	
19	107.8																19
20	105.9																20
22	102																22
24	98.2																24
26	94.4																26
28	90.6																28
30	87				87												30
32	83.3	71.5			84.8												32
34	79.7	68.9			82.6				79.4								34
36	76	66.3			80.3				77.7								36
38	72.5	63.8			78.1				76				70.6				38
40	69.9	61.6			75.9				74.3				69.4				40
45	63.9	56.4	50.6		71.2	59.5			70				66.2				45
50	57.9	51.3	46.6		67.2	56.4			66.4	55.2			63.1	53.8			50
55	52.8	47.7	43.4		63.3	53.5	47		63.2	52.7			60.2	52			55
60	49.1	44	40.3		59.5	51.1	45		60	50.4	44.5		57.8	49.9			60
65	45.3	40.7	37.9	31.7	56.5	48.7	43.1		56.9	48.4	42.8		55.4	47.9	41.9		65
70	41.6	38.3	35.4	30.3	53.9	46.4	41.2		54.2	46.4	41.2		53	46.3	40.5		70
75	38.4	35.9	33.4	28.9	51.2	44.4	39.4	31	52	44.5	39.6	30.9	50.7	44.7	39.2		75
80	36	33.4	31.6	27.7	48.5	42.6	37.8	30.1	49.8	42.8	38.1	30.1	48.7	43.1	37.9	30	80
85	33.7	31.4	29.9	26.5	46.2	40.7	36.3	29.2	47.7	41.2	36.6	29.3	47	41.6	36.7	29.2	85
90	31.4	29.8	28.3	25.5	44.2	38.8	34.9	28.4	45.6	39.7	35.4	28.5	45.2	40.3	35.4	28.5	90
95	29.5	28.1	27	24.6	42.4	37.3	33.5	27.6	43.6	38.1	34.2	27.8	43.6	39	34.4	27.8	95
100	27.9	26.5	25.7	23.7	40.5	35.9	32.4	26.8	42.1	36.6	33	27.1	41.9	37.7	33.3	27.1	100
105	26.4	25.3	24.5	23.1	38.7	34.5	31.3	26.2	40.6	35.4	31.9	26.5	40.4	36.4	32.3	26.5	105
110	24.9	24.2	23.6	22.6	36.8	33.2	30.3	25.6	39	34.2	31	25.9	39.1	35.1	31.3	26	110
115	23.7	23.1	22.8	22.6	35.1	31.8	29.2	25	37.5	33.1	30.1	25.4	37.9	33.9	30.3	25.4	115
120	22.6	22.3	22.3		33.7	30.4	28.3	24.5	36	31.9	29.2	24.9	36.7	33	29.6	25	120
125					32.5	29.4	27.4	24	34.4	30.8	28.3	24.4	35.4	32	28.8	24.6	125
130					31.3	28.5	26.7	23.6	33.2	29.7	27.4	23.9	34.2	31.1	28.1	24.1	130
135					30	27.6	25.9	23.2	32.1	28.7	26.7	23.5	33	30.1	27.3	23.7	135
140					28.8	26.7	25.2	22.9	31.1	27.9	26.1	23.1	31.8	29.2	26.6	23.4	140
145					27.7	25.8	24.5	22.6	30	27.1	25.5	22.8	30.6	28.2	25.9	23.1	145
150					26.8	25.1	24	22.3	29	26.4	24.9	22.6	29.5	27.5	25.3	22.7	150
155					26	24.4	23.5	22.1	27.9	25.6	24.2	22.3	28.4	26.8	24.8	22.4	155
160					25.2	23.8	23	22	27	24.9	23.7	22.1	27.3	26.1	24.3	22.2	160
165					24.3	23.2	22.5	22	26.3	24.2	23.3	21.9	26.1	25.4	23.8	22.1	165
170					23.5	22.6	22.2	22	25.5	23.7	22.9	21.9	25	24.7	23.3	21.9	170
175					23	22.2	21.9	22	24.8	23.2	22.5	21.9	23.9	24	22.7	21.7	175
180					22.4	21.8	21.7		24.1	22.7	22.1	21.8	22.9	23.2	22.1	21.6	180
185					21.9	21.5	21.6		23.4	22.2	21.9	21.8	21.9	22.3	21.6	21.5	185
190					21.6	21.4	21.6		22.9	21.8	21.7	21.8	20.9	21.3	21	21.4	190
195									22.4	21.6	21.6		19.9	20.4	20.4	20.9	195
200									22	21.4	21.5		18.9	19.5	19.6	20	200
205									20.9	21.2	21.4		18	18.5	18.7	19	205
210									12.8	15.4			17.2	17.6	17.8		210
215													16.4	16.7	16.9		215
220													15.4	15.8	16		220
225													10.8	13.4	8.1		225

* adapter - piece d'adaptateur

Lifting capacities

Forces de levage

TF 69

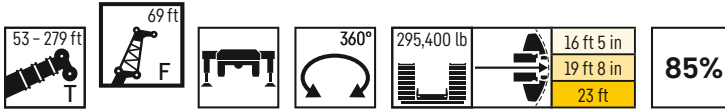

	174 ft + 7 ft 7 in*				191 ft + 7 ft 7 in*				209 ft + 7 ft 7 in*				226 ft + 7 ft 7 in*				
	0°	10°	20°	40°	0°	10°	20°	40°	0°	10°	20°	40°	0°	10°	20°	40°	
45	60.9																45
50	58.6				53.2												50
55	56.4				51.4				43.1				25.9				55
60	54.2	47.6			49.4				41.7				34.2				60
65	52.1	46			47.5	43.1			40.3				33.2				65
70	50.1	44.5	39.3		45.5	41.9			38.9	38.4			32.2				70
75	48	43.1	38.2		43.4	40.8	36.5		37.4	37.4			31.2	30.4			75
80	46.3	41.8	37.1		41.2	39.5	35.6		35.8	36.3	31		30.2	29.5			80
85	44.6	40.6	36	28.9	39.1	38.2	34.8		34.1	35.2	32.9		29.1	28.6	24.7		85
90	42.9	39.3	35	28.2	37	36.8	33.9	27.9	32.5	33.9	32.2		27.9	27.7	27.4		90
95	41.1	38	34	27.8	35	35.5	33	27.7	30.8	32.4	31.4		26.8	26.8	26.5		95
100	39.4	36.6	33	27.5	33.6	34.1	32.2	27.4	29.2	30.8	30.5	26.5	25.6	25.9	25.7		100
105	37.6	35.6	32.1	27.1	32.3	32.7	31.3	26.9	27.7	29.2	29.4	26.1	24.4	25	24.9	24.5	105
110	35.8	34.6	31.2	26.6	30.9	31.1	30.4	26.4	26.3	27.6	28.3	25.6	23.3	24	24.2	24	110
115	34.2	33.6	30.3	26.1	29.6	29.7	29.2	25.9	25.3	26.2	27.2	25.2	22.1	23.1	23.5	23.3	115
120	32.8	32.6	29.5	25.6	28.2	28.5	28	25.5	24.3	24.8	26.1	24.8	21	22.1	22.8	22.6	120
125	31.5	31.5	28.5	25.2	26.9	27.3	27.1	25.1	23.2	23.5	24.8	24.4	19.9	21.1	22.1	21.9	125
130	30.2	30.3	27.8	24.8	25.8	26.1	26.1	24.6	22.2	22.3	23.4	23.8	18.9	20	21.1	21.3	130
135	28.9	29.2	27.2	24.5	24.8	24.9	25.2	24	21.2	21.4	22	23.3	18.2	18.9	20.1	20.6	135
140	27.6	28	26.5	24.1	23.8	23.9	24.3	23.4	20.3	20.6	20.8	22.7	17.5	17.8	19	20	140
145	26.4	26.9	25.9	23.7	22.8	23	23.3	22.8	19.5	19.7	20.1	21.9	16.9	16.8	17.8	19.3	145
150	25.1	25.7	25.3	23.4	21.8	22	22.3	22.2	18.7	18.9	19.3	20.7	16.2	16.2	16.7	18.6	150
155	23.9	24.6	24.6	23.1	20.7	21.1	21.4	21.7	17.9	18.1	18.5	19.5	15.6	15.6	15.7	17.8	155
160	22.8	23.5	23.7	22.9	19.7	20.1	20.4	20.9	17.1	17.4	17.7	18.2	14.9	15	14.9	16.8	160
165	21.9	22.4	22.7	22.6	18.7	19.2	19.4	20	16.3	16.6	16.9	17.2	14.3	14.4	14.4	15.8	165
170	20.9	21.4	21.6	22	17.8	18.2	18.5	19	15.5	15.8	16.1	16.5	13.6	13.8	13.8	14.8	170
175	19.9	20.4	20.6	21.1	17	17.3	17.6	18.1	14.7	15	15.3	15.8	13	13.3	13.3	13.7	175
180	18.9	19.5	19.6	20.1	16.1	16.5	16.8	17.2	13.9	14.2	14.6	15.1	12.3	12.7	12.7	12.8	180
185	17.9	18.5	18.6	19.1	15.3	15.7	16	16.4	13.2	13.5	13.9	14.3	11.7	12.1	12.2	12.3	185
190	17	17.5	17.7	18.2	14.5	14.9	15.1	15.6	12.6	12.9	13.2	13.6	11	11.5	11.7	11.9	190
195	16.2	16.6	16.9	17.3	13.7	14.1	14.3	14.8	12	12.3	12.6	12.9	10.4	11	11.1	11.4	195
200	15.5	15.9	16.1	16.5	12.9	13.2	13.4	14	11.4	11.7	11.9	12.3	9.9	10.4	10.6	11	200
205	14.7	15.1	15.3	15.6	12.1	12.4	12.8	13.2	10.8	11.1	11.2	11.7	9.3	9.9	10.2	10.5	205
210	14	14.4	14.4	14.8	11.5	11.8	12.1	12.5	10.2	10.5	10.6	11	8.8	9.4	9.7	10	210
215	13.2	13.6	13.7	14	11	11.2	11.5	11.8	9.6	9.9	10	10.4	8.4	8.9	9.2	9.6	215
220	12.5	12.9	13	13.3	10.5	10.7	10.9	11.1	9	9.3	9.5	9.9	7.9	8.4	8.7	9.1	220
225	11.9	12.2	12.3		10	10.2	10.2	10.5	8.5	8.8	9	9.4	7.4	7.9	8.2	8.6	225
230	11.2	11.5	11.7		9.5	9.6	9.7	9.9	8	8.3	8.5	8.9	6.9	7.5	7.7	8.1	230
235	10.6	10.9	11		8.9	9.1	9.2	9.3	7.5	7.8	8	8.4	6.4	7	7.3	7.6	235
240	9.6	10.3	10.3		8.5	8.6	8.7		7.1	7.3	7.5	7.9	5.9	6.5	6.8	7.1	240
245	5.4				8.1	8.2	8.3		6.6	6.8	7	7.3	5.5	6.1	6.4	6.6	245
250					7.6	7.8	7.8		6.2	6.4	6.5		5.2	5.7	5.9	6.1	250
255					7.2	7.4	7.4		5.7	5.9	6.1		4.8	5.3	5.4	5.6	255
260					4.9	5.1			5.3	5.5	5.6		4.4	4.8	5	5.1	260
265									5	5.1	5.2		4	4.4	4.6		265
270									4.6	4.7	4.7		3.6	4	4.1		270
275									3	4.4	4.3		3.2	3.6	3.7		275
280													3	3.3	3.3		280
285													2.7	3	3		285
290													2.4	2.6	2.6		290

* adapter - piece d'adaptateur

Lifting capacities

Forces de levage

TF 69

	243 ft + 7 ft 7 in*				259 ft + 7 ft 7 in*				261 ft + 7 ft 7 in*				276 ft + 7 ft 7 in*				279 ft + 7 ft 7 in*					
	0°	10°	20°	40°	0°	10°	20°	40°	0°	10°	20°	40°	0°	10°	20°	40°	0°	10°	20°	40°		
60	23.5																				60	
65	26.2				19.1					20.9											65	
70	25.5				18.5					20.4				16.7							70	
75	24.8	20.7			18					19.8				16.3				16			75	
80	24	23.7			17.4	17.1				19.3				15.8				15.5			80	
85	23.3	23.1			16.9	16.7				18.7	18.4			15.4				15.1			85	
90	22.7	22.4	18.5		16.4	16.2				18.2	17.9			14.9	14.8			14.6	14.6		90	
95	22	21.7	21.7		15.9	15.7	15.4			17.7	17.5	16.9		14.4	14.4			14.2	14.2		95	
100	21.4	21.1	21.1		15.3	15.2	15			17.2	17	16.6		14	14	13.9		13.7	13.8		100	
105	20.8	20.5	20.4		14.8	14.7	14.6			16.7	16.6	16.2		13.5	13.6	13.6		13.2	13.3	13.4	105	
110	20.2	19.9	19.8	19.7	14.3	14.2	14.2			16.2	16.1	15.8		13.1	13.2	13.3		12.6	12.9	13	110	
115	19.5	19.4	19.3	19.3	13.7	13.8	13.8	13		15.7	15.7	15.4	14.3	12.6	12.8	12.9		12.1	12.5	12.7	115	
120	18.9	18.8	18.7	18.8	13.2	13.3	13.3	12.6		15.2	15.2	14.9	14	12.2	12.4	12.5	12.1	11.6	12	12.3	120	
125	18.1	18.2	18.2	18.3	12.7	12.8	12.9	12.2		14.7	14.7	14.5	13.7	11.8	11.9	12.1	11.8	11	11.5	11.9	11.7	125
130	17.2	17.6	17.6	17.8	12.2	12.3	12.5	11.9		14.2	14.3	14.1	13.3	11.3	11.5	11.7	11.4	10.5	11	11.5	11.3	130
135	16.3	16.9	17	17.2	11.7	11.9	12	11.5		13.6	13.8	13.6	13	10.9	11.1	11.3	11.1	9.9	10.5	11	11.1	135
140	15.4	16.1	16.4	16.7	11.2	11.4	11.6	11.2		13	13.3	13.2	12.6	10.4	10.7	10.9	10.9	9.4	10	10.6	10.8	140
145	14.6	15.3	15.8	16.1	10.7	10.9	11.2	10.9		12.5	12.8	12.8	12.2	10	10.2	10.5	10.6	8.8	9.5	10.2	10.6	145
150	13.7	14.5	15.1	15.6	10.2	10.5	10.7	10.6		11.9	12.3	12.4	11.9	9.5	9.8	10.1	10.4	8.3	9	9.7	10.3	150
155	12.8	13.7	14.4	15.1	9.7	10	10.3	10.4		11.3	11.8	12	11.6	9.1	9.4	9.7	10.1	7.7	8.5	9.2	10	155
160	12.2	12.9	13.8	14.5	9.2	9.6	9.9	10.1		10.7	11.3	11.6	11.3	8.6	9	9.3	9.8	7.1	7.9	8.7	9.6	160
165	11.7	12.2	13.1	13.9	8.7	9.1	9.5	9.8		10.2	10.8	11.3	11	8.2	8.6	8.9	9.4	6.6	7.3	8.1	9.1	165
170	11.3	11.4	12.3	13.2	8.3	8.7	9	9.5		9.6	10.2	10.9	10.7	7.7	8.2	8.5	9.1		6.8	7.5	8.6	170
175	10.9	10.8	11.6	12.5	7.8	8.2	8.6	9.1		8.9	9.7	10.5	10.3	7.3	7.7	8.1	8.7		6.2	6.9	8.1	175
180	10.4	10.4	10.8	11.8	7.3	7.8	8.1	8.6		8.3	9.1	10	9.9	6.8	7.3	7.7	8.3		5.6	6.4	7.6	180
185	10	10	10.1	11.1	6.8	7.3	7.7	8.2		7.7	8.5	9.3	9.5	6.3	6.9	7.3	7.9		5.1	5.8	7	185
190	9.5	9.6	9.7	10.4	6.4	6.8	7.2	7.8		7.1	7.8	8.6	9.1	5.8	6.4	6.8	7.5		4.6	5.2	6.4	190
195	9.1	9.2	9.4	9.6	5.9	6.4	6.8	7.4		6.4	7.2	7.9	8.7	5.2	5.8	6.2	7.1		4.1	4.7	5.8	195
200	8.6	8.8	9	9.2	5.4	5.9	6.3	7		5.8	6.5	7.2	8.2	4.7	5.3	5.7	6.7		3.5	4.2	5.2	200
205	8.2	8.4	8.7	8.9	5	5.4	5.8	6.5		5.2	5.9	6.6	7.6	4.1	4.7	5.2	6.3		2.9	3.7	4.6	205
210	7.7	8	8.3	8.6	4.5	5	5.4	6			5.9	6.9	3.5	4.2	4.6	5.8			2.3	3	4.1	210
215	7.3	7.6	7.9	8.3	4	4.5	4.9	5.5			5.2	6.2	2.8	3.6		5.3			1.7	2.3	3.5	215
220	6.9	7.2	7.4	7.9	3.6	4.1	4.5	5			4.6	5.5		2.9		4.6					2.8	220
225	6.5	6.8	7	7.5	3.2	3.6	4	4.6			4	4.8		2.2							2	225
230	6.1	6.4	6.6	7	2.6	3.2	3.6	4.1			3.4	4.2										230
235	5.7	6	6.2	6.6	2.1	2.7	3.1	3.6			2.7	3.5										235
240	5.3	5.6	5.8	6.1	1.6	2.2	2.6	3.1				2.8										240
245	4.9	5.2	5.4	5.7		1.7	2	2.6				1.9										245
250	4.5	4.8	5	5.3																		250
255	4.1	4.4	4.6	4.8																		255
260	3.8	4	4.2	4.4																		260
265	3.4	3.6	3.8	4																		265
270	3.1	3.3	3.4	3.5																		270
275	2.7	2.9	3	3.1																		275
280	2.4	2.5	2.7																			280
285	1.9	2.1	2.3																			285
290		1.6	1.8																			290

* adapter - piece d'adaptateur

Lifting capacities

Forces de levage

TF 80

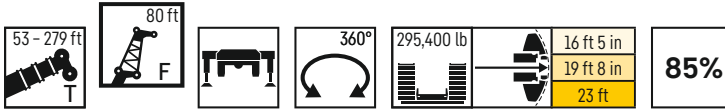

	53 ft + 7 ft 7 in*				122 ft + 7 ft 7 in*				139 ft + 7 ft 7 in*				157 ft + 7 ft 7 in*				
	0°	10°	20°	40°	0°	10°	20°	40°	0°	10°	20°	40°	0°	10°	20°	40°	
22	94.5																22
24	90.2																24
26	85.8																26
28	81.6																28
30	77.9																30
32	75				75.3												32
34	72.2				73.5												34
36	69.3	60.1			71.6				68								36
38	66.4	58.1			69.8				66.6								38
40	63.5	56.1			67.9				65.1				60.7				40
45	57.9	51.5			63.4				61.6				58				45
50	53.3	47.3	42.7		60	50.7			58.2	49.2			55.4				50
55	48.7	43.3	39.5		56.8	48.1			55.4	47.2			52.7	45.3			55
60	44.7	40.3	36.8		53.4	45.8	39.4		52.8	45.1			50.6	43.6			60
65	41.6	37.4	34.3		50.4	43.8	37.8		50.2	43.2	37.3		48.6	41.9			65
70	38.6	34.5	32.2	27.5	48.1	41.9	36.1		47.5	41.5	36		46.6	40.3	35.2		70
75	35.6	32.6	30.3	26.3	45.9	39.9	34.6		45.6	39.9	34.6		44.5	39	34.1		75
80	32.8	30.6	28.4	25.2	43.7	38.2	33.1	26.7	43.7	38.2	33.3		42.6	37.6	33		80
85	30.7	28.7	26.9	24.2	41.5	36.6	31.7	26	41.9	36.7	32	26	41.2	36.3	31.9		85
90	28.8	26.8	25.5	23.2	39.6	35	30.5	25.2	40.1	35.4	30.8	25.2	39.8	35	30.8	25.1	90
95	27	25.3	24.1	22.2	37.9	33.4	29.3	24.5	38.4	34.1	29.7	24.6	38.3	33.9	29.7	24.4	95
100	25.2	24	22.8	21.3	36.3	32	28.2	23.8	36.8	32.8	28.7	23.9	36.9	32.8	28.7	23.8	100
105	23.8	22.7	21.8	20.5	34.7	30.8	27.1	23.1	35.5	31.5	27.7	23.3	35.5	31.7	27.9	23.3	105
110	22.6	21.4	20.9	19.8	33.2	29.7	26.2	22.5	34.2	30.4	26.7	22.7	34.1	30.7	27	22.7	110
115	21.3	20.5	19.9	19.2	31.6	28.5	25.4	21.9	32.9	29.3	25.9	22.2	33	29.6	26.1	22.2	115
120	20.1	19.6	19.2	18.8	30.1	27.4	24.5	21.4	31.6	28.4	25.1	21.7	31.9	28.6	25.3	21.7	120
125	19.2	18.7	18.5	18.6	28.8	26.2	23.6	20.9	30.4	27.4	24.4	21.2	30.9	27.8	24.6	21.3	125
130	18.3	18.1	18		27.8	25.2	22.9	20.4	29.1	26.4	23.6	20.7	29.8	27	24	20.9	130
135	17.7	17.6			26.7	24.4	22.2	20	27.9	25.4	22.9	20.3	28.8	26.2	23.3	20.5	135
140					25.7	23.6	21.6	19.6	27	24.5	22.2	20	27.7	25.4	22.7	20.1	140
145					24.6	22.8	21	19.3	26.1	23.8	21.6	19.6	26.7	24.6	22.1	19.8	145
150					23.6	22.1	20.4	19	25.2	23.1	21.1	19.3	25.8	23.8	21.5	19.5	150
155					22.7	21.3	19.8	18.7	24.3	22.4	20.6	18.9	25	22.9	20.9	19.2	155
160					22	20.7	19.4	18.5	23.5	21.8	20.1	18.7	24.3	22.3	20.5	18.9	160
165					21.3	20.1	18.9	18.3	22.6	21.1	19.6	18.5	23.6	21.8	20.1	18.6	165
170					20.6	19.6	18.5	18.2	21.8	20.5	19.1	18.3	22.9	21.3	19.6	18.4	170
175					19.9	19.1	18.1	18.1	21.2	20	18.8	18.1	22.2	20.7	19.2	18.3	175
180					19.2	18.5	17.8	18.1	20.7	19.5	18.5	18.1	21.5	20.2	18.8	18.1	180
185					18.7	18.2	17.6	18.1	20.1	19.1	18.1	18.1	20.7	19.7	18.5	18	185
190					18.3	17.9	17.4		19.5	18.7	17.8	18	19.9	19.1	18.2	17.9	190
195					17.8	17.6	17.4		18.9	18.2	17.6	18	19.1	18.5	17.9	17.9	195
200					17.5	17.4	17.4		18.4	17.9	17.5	18	18.3	18	17.7	17.9	200
205					12.5				18.1	17.7	17.3		17.5	17.4	17.4	17.9	205
210									17.7	17.5	17.2		16.7	16.9	17	17.4	210
215									17.3	17.3	17.2		15.9	16.3	16.3	17	215
220									13.2	16.3			15.1	15.6	15.6		220
225													14.4	14.8	14.9		225
230													13.7	14	14.2		230
235													11	13.2	13.2		235

* adapter - piece d'adaptateur

Lifting capacities

Forces de levage

TF 80

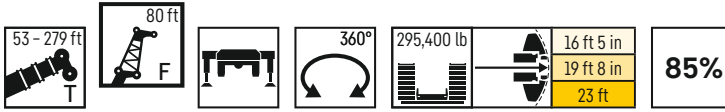

	174 ft + 7 ft 7 in*				191 ft + 7 ft 7 in*				209 ft + 7 ft 7 in*				226 ft + 7 ft 7 in*				
	0°	10°	20°	40°	0°	10°	20°	40°	0°	10°	20°	40°	0°	10°	20°	40°	
45	54																45
50	52.1				46.9												50
55	50.1				45.5				35.2								55
60	48.2	41.4			44.1				38.4				30.8				60
65	46.4	40.1			42.8				37.2				30.1				65
70	44.9	38.8			41.3	36.4			36.1				29.2				70
75	43.4	37.5	33		39.8	35.4			34.9	32.7			28.3				75
80	41.9	36.3	32.1		38.1	34.4	30.7		33.6	32			27.5	26.5			80
85	40.4	35.3	31.2		36.5	33.5	30		32.2	31.2	18.1		26.6	25.8			85
90	38.8	34.2	30.3		34.8	32.6	29.2		30.7	30.5	27.6		25.6	25			90
95	37.1	33.1	29.4	24.2	33.2	31.8	28.5		29.2	29.6	27.2		24.7	24.3	24		95
100	35.9	32.1	28.5	23.6	31.6	31	27.7	23.1	27.8	28.4	26.9		23.7	23.6	23.3		100
105	34.7	31.2	27.6	23.1	30.2	30.2	27	22.7	26.4	27.3	26.4		22.8	22.9	22.6		105
110	33.5	30.3	26.8	22.6	29.1	29.2	26.2	22.2	25	26.1	25.8	21.5	21.9	22.2	22		110
115	32.3	29.4	26	22.1	27.9	28	25.4	21.8	23.7	25	25.2	21.1	20.9	21.6	21.3	20.3	115
120	31.2	28.5	25.3	21.7	26.7	26.8	24.8	21.4	22.5	23.8	24.6	20.8	19.9	20.9	20.7	20	120
125	30	27.7	24.6	21.2	25.5	25.7	24.1	21	21.6	22.7	24	20.4	18.9	20.2	20.2	19.7	125
130	28.9	26.6	23.9	20.8	24.3	24.7	23.4	20.6	20.7	21.5	23.1	20.1	17.9	19.5	19.6	19.3	130
135	27.7	25.8	23.2	20.5	23.3	23.6	22.8	20.3	19.8	20.3	22	19.8	16.9	18.5	18.9	18.7	135
140	26.6	25	22.6	20.1	22.4	22.6	22.1	19.9	19	19.2	20.8	19.5	16.1	17.6	18.1	18.2	140
145	25.5	24.3	22.1	19.8	21.5	21.7	21.5	19.6	18.2	18.5	19.6	19.2	15.5	16.6	17.3	17.7	145
150	24.3	23.5	21.6	19.5	20.6	20.8	20.8	19.3	17.5	17.7	18.4	19	14.9	15.6	16.5	17.1	150
155	23.2	22.7	21.1	19.2	19.7	20	20	19	16.8	17	17.3	18.4	14.4	14.7	15.6	16.6	155
160	22.1	22	20.6	18.8	18.8	19.1	19.2	18.7	16.1	16.3	16.5	17.6	13.8	13.7	14.8	16	160
165	21.1	21.2	20.1	18.6	17.9	18.3	18.4	18.4	15.4	15.6	15.8	16.8	13.3	13.2	13.9	15.3	165
170	20.2	20.4	19.5	18.4	17.1	17.4	17.6	18	14.6	14.9	15.2	15.8	12.7	12.7	13.1	14.5	170
175	19.3	19.6	18.8	18.2	16.2	16.6	16.8	17.3	13.9	14.2	14.5	14.9	12.2	12.2	12.2	13.7	175
180	18.4	18.7	18.2	18	15.4	15.7	16	16.6	13.2	13.5	13.9	14.1	11.6	11.7	11.8	12.9	180
185	17.5	17.8	17.5	17.5	14.7	15	15.3	15.8	12.5	12.8	13.2	13.5	11.1	11.2	11.4	12	185
190	16.7	16.9	16.9	17	14	14.3	14.5	15.1	11.8	12.1	12.6	12.9	10.6	10.8	10.9	11.2	190
195	15.8	16.1	16.2	16.5	13.3	13.6	13.8	14.3	11.3	11.5	12	12.4	10	10.3	10.5	10.5	195
200	14.9	15.2	15.5	16	12.5	12.9	13	13.6	10.7	10.9	11.5	11.8	9.5	9.8	10.1	10.2	200
205	14.2	14.4	14.8	15.3	11.8	12.2	12.3	12.9	10.2	10.4	11	11.2	9	9.3	9.6	9.9	205
210	13.6	13.8	14	14.5	11.1	11.5	11.5	12.2	9.6	9.9	10.4	10.7	8.5	8.8	9.2	9.6	210
215	12.9	13.1	13.3	13.7	10.5	10.8	11	11.5	9.1	9.3	9.9	10.2	8	8.4	8.7	9.2	215
220	12.2	12.4	12.6	13	9.9	10.2	10.5	10.9	8.5	8.8	9.4	9.7	7.6	7.9	8.2	8.8	220
225	11.6	11.8	11.9	12.3	9.5	9.8	10	10.4	8	8.3	8.9	9.2	7.1	7.5	7.8	8.3	225
230	10.9	11.1	11.4	11.6	9	9.3	9.5	9.8	7.4	7.8	8.4	8.7	6.7	7	7.3	7.8	230
235	10.4	10.6	10.8		8.6	8.8	9	9.3	7	7.3	7.9	8.2	6.2	6.6	6.9	7.3	235
240	9.9	10.1	10.3		8.1	8.4	8.5	8.8	6.6	6.9	7.4	7.7	5.8	6.1	6.4	6.8	240
245	9.5	9.6	9.7		7.7	7.9	8.1	8.2	6.1	6.4	6.9	7.2	5.3	5.7	6	6.4	245
250	9	9.1	9.2		7.3	7.5	7.6		5.7	6	6.4	6.7	5	5.3	5.6	5.9	250
255	6	6.1			6.8	7	7.2		5.3	5.5	5.9	6.1	4.6	4.9	5.1	5.4	255
260					6.4	6.6	6.8		4.9	5.1	5.5	5.6	4.2	4.5	4.7	5	260
265					6	6.1	6.2		4.4	4.6	5.1		3.9	4.1	4.3	4.5	265
270					3.7	5.6			4.1	4.3	4.6		3.5	3.7	3.9	4	270
275									3.8	3.9	4.2		3.1	3.3	3.5	3.5	275
280									3.4	3.6	3.8		2.7	2.9	3.1		280
285									1.7	3.2	3.3		2.4	2.6	2.7		285
290													2.1	2.3	2.3		290
295													1.8	1.9	1.9		295

* adapter - piece d'adaptateur

Lifting capacities

Forces de levage

TF 80

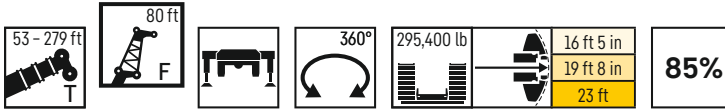

	243 ft + 7 ft 7 in*				259 ft + 7 ft 7 in*				261 ft + 7 ft 7 in*				276 ft + 7 ft 7 in*				279 ft + 7 ft 7 in*			
	0°	10°	20°	40°	0°	10°	20°	40°	0°	10°	20°	40°	0°	10°	20°	40°	0°	10°	20°	
65	23.8																			65
70	23.1				16.7															70
75	22.5				16.2															75
80	21.9				15.7															80
85	21.2	21			15.2															85
90	20.6	20.4			14.7	14.4														90
95	20	19.8			14.3	14														95
100	19.5	19.3	19.2		13.8	13.6														100
105	18.9	18.7	18.7		13.3	13.2	12.9													105
110	18.3	18.1	18.1		12.9	12.8	12.5													110
115	17.8	17.6	17.6		12.4	12.4	12.1													115
120	17.2	17.1	17.1	16.5	11.9	12	11.7													120
125	16.6	16.6	16.6	16.2	11.5	11.6	11.4	10.8												125
130	15.9	16.1	16.1	15.9	11	11.2	11.1	10.5	12.9	12.8	12.4	11.2	10.2	10.3	10.4	10.1	9.5	10	10.3	130
135	15.2	15.5	15.6	15.5	10.6	10.7	10.7	10.2	12.4	12.4	12.1	11	9.8	10	10.1	9.9	9	9.6	10	135
140	14.5	15	15.1	15.1	10.1	10.3	10.4	10	11.9	12	11.7	10.8	9.4	9.6	9.8	9.7	8.5	9.2	9.6	140
145	13.7	14.3	14.6	14.7	9.7	9.9	10.1	9.7	11.4	11.6	11.3	10.6	9	9.2	9.4	9.4	8	8.7	9.2	145
150	13	13.6	14.1	14.2	9.2	9.5	9.8	9.5	10.9	11.2	11	10.4	8.6	8.8	9.1	9.2	7.5	8.3	8.9	150
155	12.2	13	13.5	13.8	8.8	9.1	9.4	9.2	10.4	10.8	10.6	10.2	8.2	8.5	8.7	9	7	7.8	8.5	155
160	11.5	12.3	13	13.3	8.4	8.7	9	9	9.9	10.3	10.3	10	7.8	8.1	8.4	8.8	6.5	7.3	8.1	160
165	10.7	11.6	12.4	12.8	7.9	8.3	8.6	8.8	9.4	9.9	10.1	9.8	7.4	7.7	8	8.5	6	6.8	7.7	165
170	10.2	11	11.9	12.3	7.5	7.9	8.2	8.5	8.9	9.4	9.8	9.6	6.9	7.4	7.7	8.3	5.5	6.3	7.2	170
175	9.8	10.3	11.3	11.8	7.1	7.5	7.8	8.3	8.3	9	9.5	9.3		7	7.3	7.9		5.8	6.6	175
180	9.4	9.6	10.6	11.3	6.6	7.1	7.5	8	7.8	8.5	9.2	9.1		6.6	7	7.6		5.3	6.1	180
185	9	9.2	9.9	10.7	6.2	6.7	7.1	7.7	7.2	8.1	8.9	8.8		6.2	6.6	7.3			5.5	185
190	8.6	8.8	9.2	10.2	5.8	6.3	6.6	7.3	6.6	7.5	8.4	8.4		5.9	6.2	6.9			5	190
195	8.2	8.4	8.5	9.6	5.3	5.8	6.2	6.9	6	6.9	7.8	8.1		5.4	5.8	6.6			4.4	195
200	7.8	8.1	8.2	9	4.9	5.4	5.8	6.5	5.5	6.3	7.2	7.7		5	5.4	6.2			4	200
205	7.5	7.7	7.9	8.3	4.5	5	5.4	6.1	4.9	5.7	6.6	7.3		4.5	4.9	5.8			3.5	205
210	7.1	7.4	7.6	7.8	4	4.6	5	5.7	4.3	5.1	5.9	7		4	4.5	5.5			2.8	210
215	6.7	7	7.3	7.6		4.1	4.6	5.3		4.5	5.3	6.4		3.4	4	5.1			2.2	215
220	6.3	6.6	6.9	7.3		3.7	4.1	4.8				5.8		2.8	3.4	4.7			1.6	220
225	5.9	6.3	6.6	7			3.7	4.4				5.1		2.1		4.2				225
230	5.5	5.9	6.2	6.7			3.3	4								3.6				230
235	5.2	5.5	5.8	6.3			2.8	3.5								3				235
240	4.8	5.1	5.4	5.9			2.3	3.1												240
245	4.4	4.7	5	5.4			1.8	2.5												245
250	4	4.4	4.6	5				1.9												250
255	3.7	4	4.2	4.6																255
260	3.3	3.6	3.8	4.1																260
265	2.9	3.3	3.5	3.7																265
270	2.6	2.9	3.1	3.3																270
275	2.2	2.6	2.7	2.9																275
280	1.8	2.1	2.3	2.5																280
285		1.7	1.8	1.9																285

* adapter - piece d'adaptateur

Lifting capacities

Forces de levage

TF 92

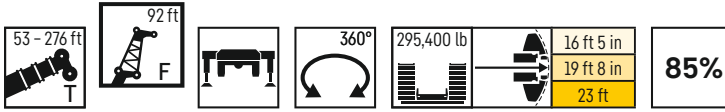

	53 ft + 7 ft 7 in*				122 ft + 7 ft 7 in*				139 ft + 7 ft 7 in*				157 ft + 7 ft 7 in*				
	0°	10°	20°	40°	0°	10°	20°	40°	0°	10°	20°	40°	0°	10°	20°	40°	
22	84.4																22
24	81.1																24
26	77.7																26
28	74.2																28
30	70.8																30
32	67.8																32
34	65.3				64.8												34
36	63				63.2												36
38	60.7				61.7				58.6								38
40	58.4	52.2			60.2				57.4								40
45	52.6	48			56.3				54.4				52				45
50	48.7	44.3			53.1	44.8			51.4				49.7				50
55	44.9	41	36.2		50.4	42.7			48.8	41.5			47.4				55
60	41.1	37.6	33.7		47.6	40.6			46.6	39.8			45.3	38.3			60
65	37.9	35.1	31.4		44.9	38.7	33.3		44.4	38			43.6	36.8			65
70	35.4	32.7	29.4		42.5	37	32		42.3	36.5	31.5		41.8	35.4			70
75	32.9	30.2	27.5		40.6	35.4	30.6		40.1	35.1	30.4		40.1	34.1	29.7		75
80	30.5	28.3	25.9	22.1	38.8	33.8	29.3		38.6	33.7	29.2		38.4	32.9	28.7		80
85	28	26.7	24.3	21.1	37	32.4	28		37	32.4	28.1		36.8	31.8	27.8		85
90	26.1	25.1	22.9	20.3	35.1	31	26.7	21.5	35.5	31.1	27		35.6	30.7	26.9		90
95	24.6	23.5	21.7	19.4	33.5	29.7	25.7	20.9	34	30	25.9	20.9	34.4	29.6	26		95
100	23.1	22	20.6	18.6	32.1	28.3	24.7	20.3	32.5	28.8	24.9	20.4	33.1	28.6	25	20.3	100
105	21.6	20.8	19.5	17.8	30.8	27	23.7	19.8	31.1	27.7	24.1	19.8	31.9	27.7	24.1	19.8	105
110	20.2	19.8	18.5	17.1	29.4	26	22.8	19.2	30	26.6	23.2	19.3	30.7	26.8	23.3	19.3	110
115	19.2	18.7	17.6	16.5	28.1	25.1	22	18.7	28.9	25.6	22.4	18.8	29.6	25.8	22.6	18.8	115
120	18.2	17.6	16.8	15.9	26.8	24.1	21.3	18.1	27.8	24.7	21.6	18.3	28.5	24.9	21.9	18.3	120
125	17.2	16.8	16	15.4	25.5	23.1	20.5	17.7	26.7	23.9	21	17.8	27.6	24	21.2	17.9	125
130	16.2	16.1	15.4	15	24.3	22.2	19.8	17.2	25.6	23	20.3	17.4	26.7	23.3	20.5	17.5	130
135	15.5	15.3	14.8	14.8	23.4	21.2	19.1	16.8	24.5	22.2	19.7	17.1	25.8	22.6	20	17.1	135
140	14.8	14.7	14.3		22.5	20.4	18.4	16.4	23.5	21.4	19.1	16.7	24.9	21.9	19.4	16.8	140
145	14.2	14.2	14.2		21.6	19.8	17.9	16.1	22.7	20.6	18.5	16.3	23.9	21.2	18.9	16.5	145
150					20.8	19.1	17.4	15.7	21.9	19.9	17.9	16	23	20.5	18.5	16.1	150
155					19.9	18.5	16.9	15.4	21.1	19.3	17.4	15.7	22.2	19.9	18	15.8	155
160					19	17.8	16.4	15.2	20.4	18.7	17	15.4	21.5	19.2	17.5	15.6	160
165					18.3	17.2	15.9	14.9	19.7	18.2	16.5	15.2	20.8	18.5	16.9	15.3	165
170					17.7	16.6	15.5	14.7	18.9	17.6	16.1	15	20.2	18.1	16.5	15.1	170
175					17.2	16.2	15.2	14.6	18.2	17	15.7	14.8	19.6	17.6	16.1	14.9	175
180					16.6	15.7	14.8	14.5	17.6	16.5	15.3	14.6	18.9	17.1	15.7	14.7	180
185					16	15.3	14.5	14.4	17.1	16.1	15	14.4	18.3	16.7	15.4	14.6	185
190					15.4	14.8	14.2	14.4	16.6	15.7	14.7	14.4	17.7	16.2	15	14.4	190
195					15	14.5	14	14.4	16.1	15.3	14.5	14.4	17.1	15.8	14.8	14.3	195
200					14.6	14.3	13.9		15.6	14.9	14.2	14.3	16.5	15.4	14.5	14.2	200
205					14.2	14	13.8		15.1	14.6	14	14.3	16	15.1	14.3	14.2	205
210					13.9	13.8	13.8		14.7	14.3	13.9	14.3	15.4	14.8	14.1	14.2	210
215					13.8	13.8			14.4	14	13.7		14.9	14.5	13.8	14.2	215
220									14.1	13.9	13.6		14.3	14.2	13.6	14.2	220
225									13.8	13.7	13.6		13.8	13.9	13.3	14.2	225
230									12.9	13.7			13.1	13.4	13		230
235													12.5	12.7	12.6		235
240													11.8	12	12.2		240
245													10.6	11.4	11.5		245
250													6.5	5.2			250

* adapter - piece d'adaptateur

Lifting capacities

Forces de levage

TF 92

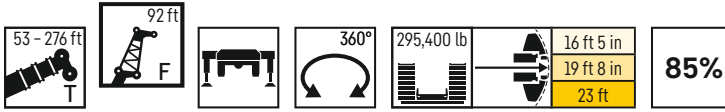

	174 ft + 7 ft 7 in*				191 ft + 7 ft 7 in*				209 ft + 7 ft 7 in*				226 ft + 7 ft 7 in*				
	0°	10°	20°	40°	0°	10°	20°	40°	0°	10°	20°	40°	0°	10°	20°	40°	
50	45.9																50
55	44.2				39.9												55
60	42.5				38.7				34.3				24.1				60
65	40.9	35			37.5				33.5				26.6				65
70	39.4	33.9			36.3	31.5			32.7				25.9				70
75	38.1	32.8			35.1	30.8			31.8				25.2				75
80	36.8	31.7	27.8		34	30			31	27.7			24.5				80
85	35.5	30.7	27.4		32.9	29.1			29.9	27			23.7	23.2			85
90	34.2	29.8	27		31.8	28.3	26.1		28.6	26.4			23	22.6			90
95	32.9	28.9	26.4		30.6	27.6	25.4		27.3	25.7	23.9		22.3	21.9			95
100	31.7	28	25.6		29.5	26.9	24.8		26	25	23.4		21.6	21.3	20.9		100
105	30.7	27.1	24.8	19.5	28.2	26.2	24.1		24.7	24.3	22.8		20.8	20.6	20.4		105
110	29.7	26.3	24	19.1	26.9	25.5	23.4	18.7	23.5	23.5	22.2		20.1	20	19.8		110
115	28.8	25.6	23.3	18.6	25.8	24.8	22.8	18.3	22.2	22.8	21.6	10.4	19.4	19.5	19.3		115
120	27.9	24.8	22.6	18.2	24.8	23.8	22.1	17.9	21.1	22	21.1	17.4	18.7	18.9	18.7		120
125	27	24	22	17.8	23.7	22.9	21.5	17.5	20	21.2	20.6	17.1	17.8	18.3	18.2	16.4	125
130	26.1	23.3	21.4	17.5	22.7	22.1	21	17.2	18.9	20.3	20.1	16.8	17	17.8	17.6	16.2	130
135	25.2	22.5	20.8	17.1	21.6	21.4	20.4	16.9	18.1	19.3	19.5	16.5	16.1	17.2	17.1	15.9	135
140	24.3	21.6	20.2	16.7	20.7	20.7	19.9	16.6	17.4	18.2	18.8	16.2	15.1	16.4	16.6	15.7	140
145	23.3	21	19.6	16.4	19.8	20	19.4	16.3	16.6	17.1	18	15.9	14.2	15.5	16	15.4	145
150	22.5	20.5	19.1	16.1	19	19.2	18.8	16	15.9	16.3	17.2	15.7	13.4	14.7	15.3	15.2	150
155	21.6	19.9	18.6	15.9	18.3	18.5	18.2	15.8	15.3	15.7	16.4	15.4	12.8	13.8	14.6	14.9	155
160	20.7	19.4	18.1	15.6	17.5	17.7	17.4	15.5	14.6	15.2	15.7	15.2	12.3	13	13.9	14.4	160
165	19.7	18.8	17.7	15.4	16.7	17	16.8	15.3	14	14.6	14.8	14.8	11.8	12.1	13.2	13.9	165
170	18.9	18.3	17.3	15.1	15.9	16.2	16.2	15.1	13.4	14	13.9	14.3	11.3	11.3	12.4	13.4	170
175	18.1	17.7	16.8	15	15.1	15.4	15.6	14.9	12.7	13.4	13.3	13.8	10.9	10.8	11.7	12.8	175
180	17.3	17.1	16.3	14.8	14.3	14.7	15	14.5	12.1	12.8	12.8	13.2	10.4	10.4	10.9	12.2	180
185	16.5	16.4	15.8	14.6	13.6	13.9	14.3	14.1	11.5	12.2	12.3	12.6	9.9	10	10.2	11.5	185
190	15.7	15.7	15.4	14.4	12.9	13.2	13.7	13.6	10.8	11.6	11.7	11.9	9.4	9.6	9.7	10.8	190
195	14.9	15	14.9	14.2	12.3	12.6	13.1	13.2	10.2	11	11.2	11.3	8.9	9.1	9.3	10.1	195
200	14.1	14.2	14.4	14	11.8	12	12.5	12.7	9.6	10.4	10.7	10.9	8.5	8.7	9	9.4	200
205	13.3	13.5	13.9	13.8	11.1	11.4	11.9	12.2	9.1	9.8	10.2	10.5	8	8.3	8.6	8.9	205
210	12.6	12.8	13.3	13.6	10.5	10.9	11.3	11.7	8.6	9.3	9.7	10.1	7.5	7.9	8.3	8.6	210
215	12	12.2	12.7	13.1	10	10.3	10.7	11.1	8.1	8.8	9.2	9.7	7.1	7.5	7.9	8.2	215
220	11.5	11.7	12.1	12.4	9.4	9.7	10.1	10.5	7.6	8.3	8.7	9.2	6.6	7.1	7.4	7.9	220
225	10.9	11.1	11.5	11.7	8.8	9.2	9.6	10	7.1	7.8	8.2	8.7	6.2	6.6	7	7.6	225
230	10.4	10.6	10.9	11	8.3	8.7	9.1	9.4	6.6	7.4	7.8	8.3	5.8	6.2	6.6	7.2	230
235	9.9	10	10.3	10.5	7.8	8.2	8.6	8.9	6.1	6.9	7.3	7.8	5.4	5.8	6.1	6.7	235
240	9.3	9.5	9.8	9.9	7.4	7.7	8.2	8.4	5.6	6.4	6.8	7.3	5	5.4	5.7	6.3	240
245	8.9	9	9.3		6.9	7.3	7.7	7.9	5.2	5.9	6.3	6.8	4.6	5	5.3	5.8	245
250	8.5	8.6	8.9		6.5	6.8	7.2	7.4	4.8	5.5	5.9	6.2	4.2	4.6	4.9	5.3	250
255	8	8.2	8.4		6	6.3	6.8	6.9	4.4	5.1	5.4	5.7	3.8	4.1	4.5	4.9	255
260	7.6	7.7	7.9		5.6	5.9	6.3		4.1	4.7	4.9	5.2	3.4	3.7	4.1	4.4	260
265	4.5	6.3			5.2	5.4	5.8		3.7	4.3	4.5	4.7	3	3.4	3.7	4	265
270					4.8	5	5.4		3.3	3.8	4	4.2	2.7	3	3.3	3.5	270
275					4.4	4.6	4.8		2.9	3.4	3.6		2.3	2.7	2.9	3.1	275
280					2.2	4.2	4.3		2.6	3.1	3.2		1.8	2.2	2.4	2.6	280
285									2.3	2.7	2.8			1.7	1.9	2	285
290									2	2.4	2.4						290
295										2	1.9						295

* adapter - piece d'adaptateur

Lifting capacities

Forces de levage

TF 92

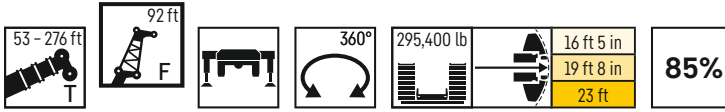

	243 ft + 7 ft 7 in*				259 ft + 7 ft 7 in*				261 ft + 7 ft 7 in*				276 ft + 7 ft 7 in*		
	0°	10°	20°	40°	0°	10°	20°	40°	0°	10°	20°	40°	0°	10°	
65	18														65
70	20.7														70
75	20.1				15.6										75
80	19.6				15.3				12.3				12.1		80
85	19				14.9				12				11.7		85
90	18.4	18.3			14.5				11.6				11.4		90
95	17.9	17.8			14.1	13.4			11.3				11		95
100	17.4	17.2			13.7	13.1			10.9	10.9			10.6	10.6	100
105	16.9	16.7	12.8		13.3	12.8			10.6	10.5			10.3	10.3	105
110	16.4	16.2	16.3		12.9	12.4	11.9		10.2	10.2			9.9	10	110
115	15.9	15.7	15.8		12.5	12.1	11.6		9.9	9.9			9.5	9.7	115
120	15.4	15.2	15.3		12.1	11.7	11.3		9.5	9.6	9.5		9.1	9.4	120
125	14.9	14.8	14.8		11.7	11.4	11.1		9.1	9.2	9.2		8.6	9.1	125
130	14.3	14.3	14.4	13.1	11.3	11.1	10.8		8.8	8.9	9		8.2	8.7	130
135	13.7	13.9	13.9	12.9	10.8	10.8	10.5	9.2	8.4	8.6	8.7		7.8	8.3	135
140	13.1	13.4	13.5	12.7	10.4	10.4	10.2	9.1	8	8.2	8.4		7.3	7.9	140
145	12.4	12.9	13.1	12.4	10	10.1	9.9	8.9	7.7	7.9	8.1	8.2	6.9	7.5	145
150	11.8	12.4	12.6	12.2	9.5	9.8	9.6	8.7	7.3	7.6	7.8	8	6.4	7.2	150
155	11.1	11.8	12.2	11.9	9.1	9.4	9.4	8.6	6.9	7.2	7.5	7.8	6	6.8	155
160	10.4	11.2	11.7	11.7	8.6	9	9.1	8.4	6.6	6.9	7.2	7.5	5.5	6.3	160
165	9.8	10.6	11.2	11.4	8.2	8.7	8.8	8.3	6.2	6.6	6.9	7.3	5	5.9	165
170	9.1	10	10.8	11	7.7	8.3	8.5	8.1	5.8	6.2	6.6	7.1	4.5	5.5	170
175	8.5	9.4	10.3	10.7	7.2	7.9	8.2	8	5.5	5.9	6.2	6.8	4	5	175
180	8.1	8.9	9.8	10.3	6.8	7.5	8	7.8		5.6	5.9	6.6		4.5	180
185	7.8	8.3	9.3	9.9	6.3	7.1	7.7	7.6		5.2	5.6	6.3		4	185
190	7.4	7.6	8.7	9.4	5.8	6.7	7.4	7.5			5.2	6		3.5	190
195	7.1	7.2	8	8.9	5.2	6.2	7.1	7.2			4.9	5.7			195
200	6.7	6.9	7.4	8.4	4.7	5.7	6.6	6.8			4.6	5.3			200
205	6.4	6.6	6.8	7.9	4.2	5.2	6.1	6.5			4.2	5			205
210	6	6.3	6.5	7.4	3.6	4.6	5.5	6.1			3.8	4.7			210
215	5.6	5.9	6.2	6.8	2.9	4	4.9	5.8			3.3	4.3			215
220	5.3	5.6	5.9	6.3	2.2	3.5	4.3	5.4			2.7				220
225	4.9	5.3	5.6	6		2.8		4.9			2.2				225
230	4.6	5	5.2	5.7		2.1		4.4			1.6				230
235	4.3	4.6	4.9	5.4				3.8							235
240	3.9	4.3	4.5	5.1											240
245	3.6	3.9	4.2	4.8											245
250	3.2	3.6	3.8	4.4											250
255	2.9	3.2	3.5	4											255
260	2.4	2.9	3.1	3.6											260
265			2.8	3.2											265
270			2.3	2.8											270
275			1.8	2.3											275
280				1.7											280

* adapter - piece d'adaptateur

Lifting capacities

Forces de levage

TF 103

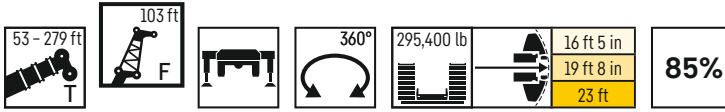

	53 ft + 7 ft 7 in*				122 ft + 7 ft 7 in*				139 ft + 7 ft 7 in*				157 ft + 7 ft 7 in*				
	0°	10°	20°	40°	0°	10°	20°	40°	0°	10°	20°	40°	0°	10°	20°	40°	
24	73.1																24
26	70.6																26
28	67.8																28
30	65.1																30
32	62.4																32
34	59.8																34
36	57.6				55.9												36
38	55.8				54.6				52.7								38
40	53.9				53.4				51.7								40
45	49.3	44			50.2				49.1				45.9				45
50	45	40.8			47.2				46.6				44				50
55	41.8	37.8			44.8	38			44.2				42.1				55
60	38.7	35.1	31.1		42.5	36.3			42.2	35.3			40.1				60
65	35.6	32.3	29		40.2	34.6			40.3	33.9			38.6	32.7			65
70	33	30.2	27.1		38	33			38.5	32.4			37.1	31.5			70
75	30.9	28.2	25.4		36.1	31.7	27.5		36.6	31.1	27.8		35.7	30.3			75
80	28.8	26.2	23.8		34.6	30.3	27		34.9	30	26.9		34.2	29.1	26.3		80
85	26.8	24.5	22.4		33.1	28.9	26.1		33.6	28.8	26		32.8	28.2	25.6		85
90	24.7	23.1	21.1	18	31.6	27.7	25		32.3	27.7	25.1		31.5	27.3	24.7		90
95	22.9	21.8	19.8	17.2	30	26.6	23.9		31	26.6	24.1		30.4	26.3	23.9		95
100	21.6	20.4	18.7	16.5	28.7	25.4	22.9	17.5	29.7	25.6	23.1		29.4	25.4	23.1		100
105	20.4	19.1	17.8	15.8	27.4	24.3	22	17	28.5	24.7	22.2	17.1	28.4	24.5	22.2		105
110	19.1	18	16.9	15.2	26.3	23.1	21.2	16.6	27.3	23.7	21.4	16.7	27.3	23.7	21.4	16.6	110
115	17.9	17.1	16	14.6	25.2	22.2	20.3	16.1	26.3	22.7	20.7	16.2	26.3	22.9	20.7	16.2	115
120	16.8	16.2	15.1	14	24.1	21.4	19.5	15.7	25.4	21.8	19.9	15.8	25.3	22.1	20	15.8	120
125	15.9	15.3	14.5	13.5	23	20.6	18.8	15.2	24.4	21	19.2	15.4	24.5	21.3	19.4	15.4	125
130	15.1	14.5	13.8	13	21.9	19.8	18.2	14.8	23.5	20.3	18.5	15	23.7	20.5	18.8	15	130
135	14.2	13.8	13.1	12.6	20.8	19	17.6	14.5	22.5	19.6	18	14.6	22.9	19.8	18.2	14.7	135
140	13.4	13.2	12.6	12.2	19.9	18.1	16.9	14.1	21.6	18.9	17.4	14.3	22.1	19.2	17.6	14.3	140
145	12.8	12.5	12.1	12	19.2	17.4	16.3	13.7	20.6	18.2	16.9	13.9	21.3	18.6	17.1	14	145
150	12.2	12	11.7	12	18.5	16.8	15.7	13.4	19.8	17.5	16.3	13.6	20.5	18	16.6	13.7	150
155	11.6	11.6	11.6		17.7	16.2	15.3	13.1	19.1	16.9	15.8	13.3	19.8	17.4	16.2	13.4	155
160					17	15.7	14.8	12.8	18.5	16.3	15.3	13	19	16.8	15.7	13.1	160
165					16.3	15.1	14.4	12.5	17.8	15.8	14.9	12.8	18.2	16.2	15.2	12.9	165
170					15.6	14.5	13.9	12.3	17.2	15.3	14.5	12.5	17.7	15.7	14.8	12.7	170
175					15	14	13.5	12.1	16.5	14.8	14.1	12.3	17.1	15.2	14.4	12.4	175
180					14.5	13.6	13.1	11.9	15.9	14.4	13.7	12.1	16.6	14.8	14	12.3	180
185					14	13.2	12.8	11.8	15.2	13.9	13.3	12	16	14.4	13.7	12.1	185
190					13.5	12.8	12.5	11.7	14.8	13.4	13	11.8	15.5	14	13.4	11.9	190
195					13	12.5	12.2	11.6	14.3	13.1	12.7	11.7	15	13.6	13.1	11.8	195
200					12.5	12.1	11.9	11.6	13.9	12.8	12.4	11.6	14.5	13.2	12.7	11.7	200
205					12.2	11.8	11.7	11.6	13.5	12.4	12.2	11.6	14	12.8	12.5	11.6	205
210					11.8	11.5	11.6	11.6	13	12.1	11.9	11.6	13.7	12.5	12.2	11.5	210
215					11.5	11.3	11.4		12.6	11.8	11.7	11.6	13.3	12.3	12	11.5	215
220					11.2	11.1	11.4		12.2	11.5	11.6	11.6	13	12	11.8	11.5	220
225					11.1	11.1			11.9	11.4	11.4	11.6	12.6	11.8	11.6	11.5	225
230									11.7	11.2	11.3		12.3	11.5	11.4	11.5	230
235									11.4	11.1	11.3		11.9	11.3	11.3	11.5	235
240									11.2	11	11.3		11.4	11	11.2		240
245									6.2				10.9	10.7	11.1		245
250													10.4	10.4	10.9		250
255													9.9	10.1	10.3		255
260													6.3	8			260

* adapter - piece d'adaptateur

Lifting capacities

Forces de levage

TF 103

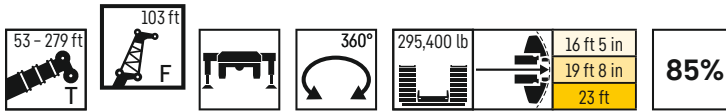

	174 ft + 7 ft 7 in*				191 ft + 7 ft 7 in*				209 ft + 7 ft 7 in*				226 ft + 7 ft 7 in*				
	0°	10°	20°	40°	0°	10°	20°	40°	0°	10°	20°	40°	0°	10°	20°	40°	
50	40.5																50
55	39.1				35.3												55
60	37.6				34.3				30.1								60
65	36.2				33.2				29.6				24.3				65
70	34.8	29.9			32.1				28.8				23.6				70
75	33.7	29			31.1	27.7			28.1				23				75
80	32.6	28			30.2	27.1			27.3				22.3				80
85	31.5	27.1			29.3	26.4			26.6	24.4			21.7				85
90	30.4	26.2	24		28.5	25.7			25.7	23.8			21.1	20.6			90
95	29.2	25.5	23.3		27.7	25	22.3		24.7	23.3			20.4	20.1			95
100	28.2	24.7	22.6		26.8	24.4	21.7		23.8	22.7	20.5		19.8	19.5			100
105	27.4	24	21.9		25.9	23.8	21.1		22.9	22.1	20		19.2	18.9	11.4		105
110	26.6	23.2	21.2		24.9	23.2	20.5		22	21.6	19.4		18.6	18.3	18.1		110
115	25.8	22.5	20.5	16	23.9	22.6	19.9		21	21.1	18.9		18	17.8	17.6		115
120	25	21.8	19.8	15.6	22.9	22	19.3	15.3	20.1	20.6	18.4		17.4	17.3	17.1		120
125	24.2	21.2	19.2	15.3	22	21.3	18.8	15	19.1	20.1	17.9	14.4	16.8	16.8	16.6		125
130	23.3	20.5	18.7	14.9	21.2	20.6	18.2	14.7	18.1	19.5	17.5	14.2	16.1	16.3	16.1		130
135	22.5	19.8	18.2	14.6	20.3	19.9	17.7	14.4	17.1	18.9	17	13.9	15.3	15.8	15.7	13.4	135
140	21.8	19.2	17.6	14.3	19.5	19.2	17.3	14	16.1	18	16.6	13.7	14.5	15.3	15.2	13.2	140
145	21.1	18.5	17.1	14	18.7	18.6	16.8	13.8	15.5	17.1	16.1	13.4	13.7	14.7	14.7	13	145
150	20.4	17.8	16.6	13.6	17.9	18.1	16.4	13.5	14.9	16.1	15.6	13.2	12.9	14	14.2	12.8	150
155	19.8	17.3	16.2	13.4	17.2	17.5	15.9	13.3	14.3	15.2	15.1	12.9	12.1	13.2	13.7	12.6	155
160	19.1	16.9	15.8	13.1	16.5	16.9	15.5	13	13.7	14.3	14.6	12.7	11.3	12.5	13.2	12.4	160
165	18.4	16.4	15.4	12.9	15.8	16.2	14.9	12.8	13.1	13.4	14.1	12.6	10.8	11.7	12.6	12.2	165
170	17.8	15.9	15	12.7	15.1	15.5	14.4	12.6	12.5	12.9	13.6	12.4	10.3	11	12	11.9	170
175	17.1	15.4	14.6	12.5	14.4	14.9	14	12.4	11.9	12.4	12.9	12.1	9.9	10.3	11.3	11.6	175
180	16.4	15	14.2	12.3	13.7	14.2	13.6	12.2	11.4	11.9	12.1	11.8	9.5	9.7	10.7	11.3	180
185	15.7	14.5	13.8	12.1	13	13.5	13.2	12.1	10.8	11.4	11.4	11.5	9.1	9.3	10.1	10.9	185
190	15	14	13.4	12	12.3	12.9	12.7	11.8	10.2	10.9	10.9	11.2	8.7	8.9	9.4	10.5	190
195	14.3	13.5	13.1	11.8	11.6	12.2	12.3	11.6	9.7	10.4	10.5	10.9	8.2	8.5	8.7	9.9	195
200	13.6	13	12.9	11.7	11.1	11.6	11.9	11.4	9.1	9.9	10.1	10.4	7.8	8.1	8.3	9.3	200
205	12.9	12.5	12.6	11.5	10.6	11	11.4	11.2	8.5	9.4	9.7	9.9	7.4	7.7	8	8.7	205
210	12.2	12	12.3	11.5	10	10.5	10.9	11	8	8.8	9.3	9.5	7	7.3	7.6	8.2	210
215	11.4	11.5	12	11.4	9.5	10.1	10.4	10.7	7.6	8.4	8.8	9.2	6.5	6.9	7.3	7.7	215
220	10.8	11.1	11.7	11.3	9	9.6	9.9	10.3	7.1	7.9	8.3	8.8	6.1	6.5	6.9	7.4	220
225	10.4	10.6	11.1	11.1	8.4	9.1	9.5	9.8	6.7	7.5	7.9	8.5	5.7	6.2	6.6	7	225
230	9.9	10.1	10.6	10.7	7.9	8.6	9	9.4	6.2	7	7.4	8.1	5.3	5.8	6.2	6.7	230
235	9.5	9.7	10.1	10.3	7.4	8.1	8.5	8.9	5.8	6.6	6.9	7.6	5	5.4	5.8	6.4	235
240	9.1	9.3	9.6	9.9	6.9	7.6	8	8.4	5.3	6.1	6.5	7.1	4.6	5	5.4	6	240
245	8.6	8.8	9.1	9.4	6.5	7.2	7.5	7.9	4.9	5.7	6	6.6	4.2	4.6	5	5.6	245
250	8.2	8.4	8.7	8.9	6.1	6.7	7	7.4	4.4	5.2	5.6	6.1	3.9	4.3	4.6	5.2	250
255	7.8	7.9	8.3		5.7	6.3	6.6	6.9	4.1	4.8	5.2	5.6	3.5	3.9	4.2	4.7	255
260	7.4	7.5	7.9		5.3	5.9	6.1	6.4	3.7	4.4	4.7	5.2	3.1	3.5	3.8	4.3	260
265	6.9	7.1	7.5		4.9	5.4	5.6	5.8	3.4	4	4.3	4.7	2.7	3.1	3.4	3.9	265
270	6.5	6.7	6.9		4.5	5	5.2		3	3.7	3.9	4.2	2.3	2.8	3.1	3.5	270
275	4.1	6.3			4.1	4.6	4.8		2.6	3.3	3.5	3.7	1.8	2.4	2.7	3	275
280					3.8	4.2	4.4		2.3	2.9	3.1	3.2		1.9	2.2	2.6	280
285					3.4	3.8	3.9		1.8	2.5	2.7			1.7	2		285
290					2.9	3.4	3.3			2.1	2.3						290
295										1.6	1.8						295

* adapter - piece d'adaptateur

Lifting capacities

Forces de levage

TF 103

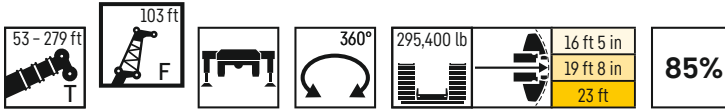

	243 ft + 7 ft 7 in*				261 ft + 7 ft 7 in*				276 ft + 7 ft 7 in*				279 ft + 7 ft 7 in*		
	0°	10°	20°	40°	0°	10°	20°	40°	0°	10°	20°	40°	0°	10°	
70	18.8														70
75	18.3				13.8										75
80	17.8				13.5				10.9						80
85	17.3				13.2				10.6				10.2		85
90	16.8				12.8				10.3				9.9		90
95	16.3	16.1			12.5				10				9.7		95
100	15.8	15.7			12.1	11.6			9.7				9.4		100
105	15.3	15.2			11.8	11.3			9.4	9.2			9.1	9	105
110	14.9	14.8	10.8		11.4	11			9	9			8.8	8.8	110
115	14.4	14.3	14.2		11.1	10.7			8.7	8.7			8.5	8.5	115
120	14	13.9	13.8		10.7	10.4	9.9		8.4	8.4			8.1	8.3	120
125	13.5	13.5	13.4		10.4	10.1	9.7		8.1	8.2	8		7.7	8	125
130	13.1	13	13		10.1	9.8	9.4		7.8	7.9	7.8		7.4	7.7	130
135	12.6	12.6	12.6		9.7	9.5	9.2		7.4	7.6	7.6		7	7.4	135
140	12.1	12.2	12.3	10.7	9.4	9.2	8.9		7.1	7.3	7.3		6.6	7.1	140
145	11.5	11.8	11.9	10.6	9	8.9	8.7	7.6	6.8	7	7.1		6.2	6.7	145
150	10.9	11.4	11.5	10.4	8.6	8.7	8.4	7.5	6.5	6.7	6.9		5.8	6.4	150
155	10.3	10.9	11.1	10.2	8.2	8.4	8.2	7.3	6.1	6.4	6.6	6.7	5.4	6	155
160	9.8	10.4	10.7	10.1	7.8	8.1	8	7.2	5.8	6.1	6.3	6.5	4.9	5.7	160
165	9.2	9.9	10.3	10	7.4	7.8	7.7	7.1	5.5	5.8	6.1	6.3	4.5	5.3	165
170	8.6	9.4	10	9.8	7	7.5	7.5	6.9	5.1	5.5	5.8	6.1	4	5	170
175	8	8.9	9.6	9.6		7.1	7.2	6.8	4.8	5.2	5.5	5.9	3.5	4.6	175
180	7.4	8.4	9.2	9.4		6.8	7	6.7	4.5	4.9	5.3	5.7	2.8	4.1	180
185	6.9	7.9	8.8	9.2		6.4	6.7	6.6		4.6	5	5.6		3.6	185
190	6.6	7.4	8.3	9		6.1	6.5	6.4		4.3	4.7	5.3		3.1	190
195	6.3	6.8	7.9	8.7		5.7	6.3	6.3		4	4.4	5.1		2.4	195
200	6	6.2	7.3	8.3		5.4	6	6.2				4.8			200
205	5.7	5.9	6.7	7.8		4.9	5.7	6				4.5			205
210	5.3	5.6	6.1	7.3		4.5	5.3	5.7				4.3			210
215	5	5.3	5.5	6.8		4	4.8	5.4				4			215
220	4.7	5	5.2	6.3		3.5	4.3	5.1				3.7			220
225	4.4	4.7	4.9	5.7		2.8	3.8	4.7				3.3			225
230	4.1	4.4	4.7	5.1		2.1	3.2	4.4							230
235	3.7	4.1	4.4	4.9				4							235
240	3.4	3.8	4.1	4.6				3.5							240
245	3.1	3.5	3.8	4.3				2.8							245
250	2.7	3.2	3.5	4											250
255	2.3	2.9	3.1	3.7											255
260	1.9	2.5	2.8	3.4											260
265		2	2.4	3											265
270		1.6		2.6											270
275				2.1											275
280				1.6											280

* adapter - piece d'adaptateur

Lifting capacities

Forces de levage

TF 115

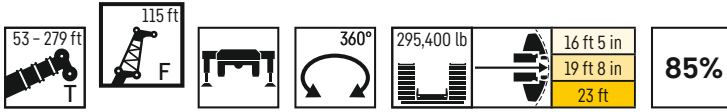

	53 ft + 7 ft 7 in*				122 ft + 7 ft 7 in*				139 ft + 7 ft 7 in*				157 ft + 7 ft 7 in*				174 ft + 7 ft 7 in*				
	0°	10°	20°	40°	0°	10°	20°	40°	0°	10°	20°	40°	0°	10°	20°	40°	0°	10°	20°	40°	
26	63.6																				26
28	61.6																				28
30	59.3																				30
32	57.1																				32
34	54.9																				34
36	52.7																				36
38	50.8				49.7																38
40	49.2				48.7				45.9												40
45	45.4				46				43.8				40.8								45
50	41.5	37.6			43.3				41.7				39.2				35.9				50
55	38.2	34.9			40.9				39.5				37.5				34.7				55
60	35.7	32.5			38.9	32.5			37.6				35.8				33.4				60
65	33.1	30.2	27.9		37	31			36	30.2			34.3				32.1				65
70	30.6	27.9	26.1		35	29.6			34.4	28.9			33	27.9			30.9				70
75	28.4	26	24.3		33.1	28.3			32.8	27.7			31.7	26.9			29.8	26.5			75
80	26.6	24.4	22.8		31.7	27.1	24.4		31.2	26.6			30.5	26			28.8	25.7			80
85	24.9	22.7	21.4		30.3	26	23.4		29.9	25.6	23.1		29.2	25.2			27.9	24.8			85
90	23.1	21.1	20		29	24.8	22.3		28.8	24.7	22.2		27.9	24.4	21.8		26.9	24			90
95	21.4	19.8	18.9		27.7	23.7	21.4		27.7	23.7	21.3		26.9	23.6	21.1		25.9	23.3	20.5		95
100	19.8	18.7	17.8	14.5	26.3	22.7	20.4		26.6	22.7	20.5		26	22.8	20.3		25	22.6	19.8		100
105	18.5	17.6	16.7	13.8	25.1	21.7	19.5		25.5	21.9	19.7		25.1	22.1	19.6		24.2	21.9	19.2		105
110	17.4	16.5	15.8	13.2	24.1	20.7	18.7	14.1	24.4	21	18.9		24.3	21.3	18.9		23.5	21.2	18.5		110
115	16.4	15.4	15	12.6	23.1	19.7	18	13.7	23.3	20.2	18.1	13.7	23.4	20.6	18.2		22.7	20.6	17.9		115
120	15.4	14.5	14.2	12.1	22.1	18.9	17.2	13.3	22.5	19.4	17.5	13.4	22.5	19.9	17.5	13.4	22	19.9	17.3		120
125	14.3	13.8	13.4	11.7	21.1	18.1	16.5	13	21.7	18.5	16.8	13	21.7	19.1	16.9	13	21.3	19.3	16.7	12.9	125
130	13.5	13	12.6	11.3	20.2	17.4	15.9	12.6	20.8	17.8	16.2	12.7	20.9	18.4	16.4	12.7	20.6	18.7	16.2	12.6	130
135	12.8	12.3	12.1	10.9	19.2	16.7	15.3	12.2	20	17.2	15.6	12.3	20.2	17.7	15.8	12.3	19.9	18.1	15.7	12.3	135
140	12.1	11.6	11.5	10.5	18.2	16	14.7	11.9	19.2	16.6	15.1	12	19.5	17	15.2	12	19.1	17.5	15.2	11.9	140
145	11.4	11.1	11	10.2	17.3	15.3	14.2	11.6	18.3	16	14.6	11.6	18.8	16.5	14.7	11.7	18.5	16.9	14.7	11.6	145
150	10.8	10.7	10.5	10	16.7	14.6	13.7	11.3	17.5	15.4	14.1	11.4	18.1	16	14.2	11.4	17.9	16.3	14.3	11.4	150
155	10.4	10.2	10.2	9.8	16	14.1	13.2	11	16.7	14.8	13.6	11.1	17.4	15.5	13.8	11.1	17.3	15.7	13.8	11.2	155
160	10	9.8	9.8	9.7	15.4	13.5	12.7	10.7	16.1	14.1	13.2	10.9	16.7	15	13.4	10.9	16.8	15.2	13.4	10.9	160
165	9.6	9.5	9.6		14.7	13.1	12.3	10.5	15.5	13.6	12.7	10.7	16	14.5	13	10.8	16.2	14.7	13	10.7	165
170	9.3	9.4			14.1	12.6	11.9	10.3	15	13.1	12.3	10.5	15.4	13.9	12.6	10.6	15.6	14.3	12.7	10.6	170
175					13.4	12.1	11.5	10.1	14.4	12.7	12	10.3	14.8	13.4	12.2	10.4	15.1	13.8	12.4	10.4	175
180					12.8	11.6	11.2	10	13.9	12.3	11.6	10.1	14.3	13	11.8	10.2	14.5	13.4	12	10.3	180
185					12.4	11.2	10.8	9.8	13.3	11.9	11.3	10	13.8	12.5	11.5	10.1	13.9	13	11.7	10.1	185
190					12	10.9	10.6	9.7	12.7	11.5	11	9.8	13.4	12.1	11.3	9.9	13.4	12.5	11.4	10	190
195					11.6	10.6	10.4	9.6	12.2	11.1	10.7	9.7	12.9	11.8	11	9.8	12.9	12.1	11	9.8	195
200					11.2	10.4	10.1	9.5	11.9	10.7	10.4	9.6	12.4	11.4	10.8	9.7	12.3	11.8	10.8	9.7	200
205					10.8	10.1	9.9	9.5	11.5	10.5	10.3	9.5	12	11	10.6	9.6	11.8	11.4	10.6	9.6	205
210					10.4	9.8	9.7	9.5	11.2	10.3	10.1	9.4	11.6	10.6	10.3	9.5	11.3	11	10.4	9.5	210
215					10.1	9.6	9.6	9.5	10.9	10.1	9.9	9.4	11.2	10.3	10.1	9.4	10.7	10.7	10.2	9.4	215
220					9.8	9.4	9.4	9.5	10.5	9.8	9.7	9.4	10.9	10.1	9.9	9.4	10.2	10.3	10.1	9.4	220
225					9.6	9.3	9.3		10.2	9.6	9.5	9.4	10.7	9.9	9.8	9.3	9.7	10	9.9	9.3	225
230					9.4	9.1	9.3		9.9	9.4	9.4	9.4	10.4	9.8	9.6	9.3	9.2	9.6	9.6	9.3	230
235					9.2	9.1	9.3		9.7	9.3	9.4	9.4	10.2	9.6	9.5	9.3	8.8	9.3	9.3	9.2	235
240									9.5	9.2	9.3		9.9	9.4	9.4	9.3	8.4	8.9	8.9	9	240
245									9.3	9.1	9.2		9.7	9.2	9.3	9.3	7.9	8.4	8.5	8.7	245
250									9.1	9	9.2		9.4	9.1	9.2	9.3	7.5	8	8.2	8.4	250
255									7.7	9			9.1	8.9	9.2		7.1	7.6	7.8	8.1	255
260													8.8	8.7	9.1		6.7	7.2	7.4	7.6	260
265													8.5	8.5	8.8		6.3	6.8	7	7.1	265
270													5.3	8.2			5.9	6.3	6.5		270
275																	5.4	5.8	6.1		275
280																	5	5.4	5.5		280
285																	3.6	5	4.9		285

* adapter - piece d'adaptateur

Lifting capacities

Forces de levage

TF 115

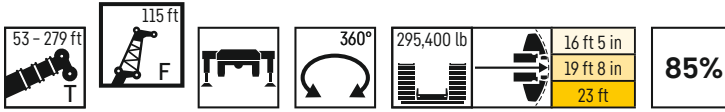

	191 ft + 7 ft 7 in*				209 ft + 7 ft 7 in*				226 ft + 7 ft 7 in*				243 ft + 7 ft 7 in*				261 ft + 7 ft 7 in*				276 ft + 7 ft 7 in*				279 ft + 7 ft 7 in						
	0°	10°	20°	40°	0°	10°	20°	40°	0°	10°	20°	40°	0°	10°	20°	40°	0°	10°	20°	40°	0°	10°	20°	40°	0°	10°	20°	40°	0°		
60	30.3																												60		
65	29.3				26.6																								65		
70	28.4				25.9																								70		
75	27.5				25.3																								75		
80	26.6	24			24.6																								80		
85	25.8	23.3			24																						8.9		8.3	85	
90	25.1	22.7			23.3	20.9																					8.6		8.1	90	
95	24.4	22			22.6	20.4																					8.4		7.9	95	
100	23.6	21.4	19		21.8	19.9																							7.7	100	
105	22.9	20.8	18.4		21.1	19.4																					9.6		7.4	105	
110	22.1	20.3	17.9		20.4	18.9	16.9																						7.2	110	
115	21.3	19.7	17.3		19.6	18.4	16.4																						7	115	
120	20.5	19.2	16.8		18.9	18	15.9																						6.8	120	
125	19.6	18.7	16.3		18.1	17.5	15.4																						6.5	125	
130	19	18.1	15.8	12.3	17.2	17	15																						6.1	130	
135	18.3	17.6	15.3	12	16.3	16.5	14.6	11.6																					5.7	135	
140	17.6	17.1	14.8	11.7	15.4	16	14.2	11.4																							140
145	17	16.6	14.4	11.5	14.5	15.4	13.8	11.1																							145
150	16.4	16	14	11.2	13.7	14.7	13.4	11																							150
155	15.7	15.5	13.6	11	13.2	13.9	13.1	10.8																							155
160	15.1	15	13.3	10.8	12.7	13.2	12.7	10.6																							160
165	14.4	14.4	12.9	10.6	12.1	12.4	12.4	10.4																							165
170	13.8	13.7	12.4	10.5	11.6	11.7	12.1	10.3																							170
175	13.2	13.2	12	10.3	11.1	11.1	11.7	10.2																							175
180	12.6	12.7	11.7	10.2	10.6	10.6	11.3	10																							180
185	11.9	12.3	11.5	10	10.1	10.2	10.8	9.9																							185
190	11.3	11.8	11.2	9.9	9.6	9.7	10.1	9.6																							190
195	10.7	11.3	11	9.8	9.1	9.3	9.4	9.4																							195
200	10	10.8	10.7	9.7	8.5	8.8	9	9.2																							200
205	9.5	10.3	10.4	9.5	8	8.4	8.6	8.9																							205
210	9	9.8	10.1	9.4	7.5	7.9	8.2	8.6																							210
215	8.5	9.3	9.7	9.4	7	7.5	7.8	8.3																							215
220	8	8.9	9.2	9.3	6.6	7	7.5	8																							220
225	7.5	8.4	8.7	9.1	6.2	6.6	7.1	7.6																							225
230	7.1	7.9	8.3	8.9	5.7	6.2	6.6	7.3																							230
235	6.6	7.4	7.8	8.4	5.3	5.8	6.2	6.9																							235
240	6.1	6.9	7.3	8	4.9	5.3	5.8	6.5																							240
245	5.6	6.4	6.9	7.5	4.5	4.9	5.4	6.1																							245
250	5.2	6	6.4	7	4.1	4.5	4.9	5.6																							250
255	4.8	5.6	6	6.5	3.7	4.1	4.5	5.1																							255
260	4.5	5.2	5.5	6	3.3	3.7	4.1	4.7																							260
265	4.1	4.7	5.1	5.4	2.9	3.3	3.7	4.2																							265
270	3.7	4.3	4.6	4.9	2.5	3	3.3	3.8																							270
275	3.3	3.9	4.2	4.4	2.1	2.6	2.9	3.3																							275
280	3	3.6	3.8	3.9	1.7	2.1	2.5	2.8																							280
285	2.6	3.2	3.4			1.6	2	2.3																							285
290	2.3	2.8	3					1.6																							290
295	2	2.4	2.6																												295
300		2	2																												300

* adapter - piece d'adaptateur

Lifting capacities

Forces de levage

TF 126

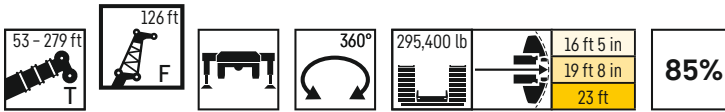

	53 ft + 7 ft 7 in*				122 ft + 7 ft 7 in*				139 ft + 7 ft 7 in*				157 ft + 7 ft 7 in*				174 ft + 7 ft 7 in*					
	0°	10°	20°	40°	0°	10°	20°	40°	0°	10°	20°	40°	0°	10°	20°	40°	0°	10°	20°	40°		
28	55.6																				28	
30	54																					30
32	52.2																					32
34	50.3																					34
36	48.5																					36
38	46.7																					38
40	44.9				43.7																	40
45	41.7				41.4				39.3													45
50	38.5				39.1				37.4				35									50
55	35.3	32.3			36.8				35.6				33.6					30.9				55
60	32.8	30.1			35				33.8				32.1					29.8				60
65	30.7	28			33.3	27.9			32.3				30.7					28.7				65
70	28.5	26.1			31.7	26.7			30.9	27			29.4					27.6				70
75	26.4	24.1	22.7		30	25.6			29.5	25.9			28.3	25				26.5				75
80	24.6	22.5	21.1		28.4	24.5			28.2	24.8			27.2	24.1				25.6	22.8			80
85	23	21.1	19.8		27.2	23.6	21.1		26.8	23.9			26.2	23.2				24.8	22.1			85
90	21.5	19.7	18.5		26.1	22.6	20.1		25.7	23	19.9		25.1	22.3				23.9	21.4			90
95	20.1	18.3	17.3		25	21.7	19.1		24.7	22.1	19.1		24	21.6	18.7			23.1	20.6			95
100	18.6	17.1	16.3		23.8	20.7	18.3		23.8	21.3	18.2		23.1	20.8	18			22.2	20	17.5		100
105	17.1	16.1	15.3	12.2	22.7	19.9	17.5		22.9	20.4	17.5		22.4	20.1	17.3			21.4	19.4	16.9		105
110	15.9	15.2	14.4	11.6	21.7	19	16.7		21.9	19.6	16.8		21.6	19.4	16.7			20.7	18.8	16.3		110
115	15	14.2	13.5	11.1	20.7	18.1	16		21	18.9	16.1		20.8	18.7	16.1			20.1	18.2	15.7		115
120	14.1	13.3	12.8	10.7	19.8	17.3	15.3	11.3	20	18.1	15.4	11.3	20	18	15.5			19.5	17.6	15.2		120
125	13.2	12.4	12.2	10.3	19	16.5	14.7	11	19.3	17.3	14.8	11.1	19.3	17.4	14.9	11		18.9	17.1	14.7		125
130	12.3	11.8	11.5	10	18.2	15.7	14	10.8	18.6	16.6	14.3	10.8	18.5	16.7	14.3	10.8		18.2	16.5	14.2		130
135	11.5	11.2	10.9	9.7	17.3	15.1	13.4	10.5	17.9	15.9	13.7	10.5	17.9	16.1	13.8	10.6		17.6	16	13.7	10.5	135
140	10.9	10.7	10.3	9.4	16.5	14.5	12.9	10.2	17.1	15.3	13.2	10.3	17.2	15.5	13.3	10.4	17	15.4	13.2	10.3		140
145	10.4	10.1	9.9	9.1	15.6	13.9	12.5	10	16.4	14.7	12.7	10.1	16.6	14.8	12.8	10.1	16.4	14.9	12.8	10.1		145
150	9.9	9.6	9.5	8.8	14.7	13.3	12	9.8	15.7	14.2	12.3	9.9	16	14.3	12.4	9.9	15.7	14.3	12.4	9.8		150
155	9.4	9.2	9.1	8.5	14.2	12.7	11.6	9.6	14.9	13.6	11.9	9.7	15.4	13.9	11.9	9.7	15.2	13.8	12	9.6		155
160	8.9	8.9	8.7	8.3	13.6	12.1	11.1	9.3	14.2	13.1	11.5	9.4	14.8	13.4	11.6	9.5	14.7	13.3	11.6	9.4		160
165	8.6	8.5	8.5	8.1	13.1	11.6	10.7	9.1	13.6	12.5	11.1	9.2	14.2	12.9	11.3	9.3	14.2	12.8	11.2	9.3		165
170	8.3	8.2	8.1	8	12.5	11.2	10.4	8.9	13.1	12	10.8	9.1	13.6	12.5	11	9.1	13.7	12.4	10.9	9.1		170
175	7.9	7.9	7.9		12	10.9	10.1	8.7	12.7	11.5	10.4	8.9	13	12	10.7	8.9	13.2	12	10.7	8.9		175
180	7.7	7.7			11.4	10.6	9.8	8.6	12.2	11.2	10.1	8.7	12.4	11.6	10.4	8.8	12.6	11.7	10.4	8.8		180
185					10.9	10.2	9.5	8.4	11.8	10.9	9.8	8.5	12	11.1	10.1	8.6	12.1	11.4	10.2	8.6		185
190					10.4	9.9	9.3	8.2	11.3	10.5	9.6	8.4	11.7	10.7	9.8	8.4	11.6	11	9.9	8.5		190
195					10.1	9.5	9	8.1	10.8	10.2	9.4	8.2	11.3	10.4	9.5	8.3	11.2	10.7	9.7	8.3		195
200					9.8	9.2	8.8	8	10.4	9.9	9.1	8.1	11	10.2	9.3	8.2	10.8	10.3	9.4	8.2		200
205					9.5	9	8.6	7.9	10	9.6	8.9	8	10.6	9.9	9.1	8.1	10.4	10	9.1	8.1		205
210					9.2	8.8	8.4	7.8	9.7	9.3	8.6	7.9	10.2	9.7	8.9	8	10	9.7	9	8		210
215					8.9	8.6	8.2	7.8	9.5	9.1	8.5	7.8	9.9	9.4	8.7	7.9	9.6	9.5	8.8	7.9		215
220					8.6	8.3	8	7.8	9.2	8.9	8.3	7.8	9.5	9.2	8.5	7.8	9.2	9.2	8.6	7.8		220
225					8.3	8.1	7.8	7.8	8.9	8.7	8.1	7.7	9.3	8.9	8.3	7.7	8.9	9	8.5	7.7		225
230					8.1	7.8	7.8	7.8	8.7	8.4	8	7.7	9.1	8.7	8.2	7.7	8.5	8.8	8.3	7.7		230
235					7.9	7.6	7.7		8.4	8.2	7.8	7.7	8.8	8.6	8.1	7.6	8.1	8.6	8.2	7.6		235
240					7.7	7.5	7.6		8.2	8	7.7	7.7	8.6	8.4	7.9	7.6	7.7	8.3	8	7.6		240
245					7.6	7.4	7.6		8	7.9	7.7	7.7	8.4	8.2	7.8	7.6	7.3	8	7.7	7.5		245
250					7.5				7.8	7.8	7.6		8.2	8.1	7.7	7.6	6.9	7.6	7.4	7.5		250
255									7.7	7.7	7.5		8	7.9	7.6	7.6	6.5	7.2	7.1	7.3		255
260									7.5	7.5	7.5		7.8	7.7	7.5	7.6	6.1	6.8	6.8	7.2		260
265									7.2	7.5			7.6	7.7	7.5		5.7	6.3	6.5	7		265
270													7.4	7.6	7.5		5.4	5.9	6.2	6.5		270
275													7.2	7.5	7.5		5	5.5	5.8	6		275
280													5.2	7.4	2		4.6	5.1	5.3			280
285																	4.2	4.7	4.9			285
290																	3.8	4.3	4.5			290
295																	3.1	3.8	3.9			295

* adapter - piece d'adaptateur

Lifting capacities

Forces de levage

TF 126

53 - 279 ft
126 ft
360°
295,400 lb
16 ft 5 in
19 ft 8 in
23 ft
85%

	191 ft + 7 ft 7 in*				209 ft + 7 ft 7 in*				226 ft + 7 ft 7 in*				243 ft + 7 ft 7 in*				261 ft + 7 ft 7 in*				276 ft + 7 ft 7 in*		279 ft + 7 ft 7 in*		
	0°	10°	20°	40°	0°	10°	20°	40°	0°	10°	20°	40°	0°	10°	20°	40°	0°	10°	20°	40°	0°	10°	0°	10°	
60	27.4																								60
65	26.7				23.5																				65
70	25.9				23				19.2																70
75	25.1				22.4				18.7				14.4												75
80	24.4				21.8				18.1				14.1				10								80
85	23.7	20.6			21.3				17.6				13.7				9.8				6.9				85
90	23	20.1			20.7				17.1				13.3				9.5				6.8		6		90
95	22.3	19.5			20.1	17.9			16.6				12.9				9.2				6.7		6		95
100	21.7	18.9			19.6	17.4			16.1	15.7			12.4				9				6.6		5.9		100
105	21	18.3	16.2		19	17			15.6	15.4			12	11.9			8.7				6.4		5.9		105
110	20.4	17.8	15.7		18.5	16.5			15.1	14.9			11.7	11.6			8.4	7.9			6.2		5.8		110
115	19.7	17.3	15.2		17.9	16.1	14.3		14.7	14.4			11.3	11.3			8.1	7.6			6		5.7		115
120	19	16.9	14.7		17.4	15.7	13.8		14.2	14	10.6		10.9	10.9			7.8	7.4			5.9	5.7	5.6		120
125	18.3	16.4	14.2		16.8	15.3	13.4		13.7	13.5	12.5		10.6	10.6	7		7.6	7.2			5.6	5.5	5.4		125
130	17.6	15.9	13.8		16.2	14.8	13		13.3	13.1	12.1		10.2	10.2	9.7		7.3	6.9			5.4	5.3	5.1		130
135	17	15.4	13.3		15.4	14.4	12.6		12.8	12.7	11.8		9.8	9.9	9.5		7	6.7	6.2		5.1	5.1	4.7		135
140	16.5	15	12.9	10.1	14.6	14	12.2		12.2	12.3	11.5		9.4	9.5	9.2		6.8	6.5	6		4.8	4.9	4.3		140
145	15.9	14.5	12.4	9.9	13.8	13.6	11.9	9.6	11.6	11.9	11.2		9.1	9.2	9		6.5	6.2	5.8		4.5	4.7	3.9		145
150	15.4	14	12.1	9.7	13	13.1	11.5	9.4	11	11.5	10.9		8.6	8.9	8.8		6.2	6	5.7		4.2	4.5	3.5		150
155	14.9	13.6	11.8	9.5	12.1	12.5	11.2	9.3	10.3	11	10.7	9	8.2	8.5	8.5		6	5.8	5.5		3.8	4.2	3		155
160	14.3	13.1	11.5	9.3	11.4	12	10.9	9.1	9.6	10.5	10.5	8.8	7.7	8.2	8.2	7.1	5.7	5.6	5.3		3.5	3.9			160
165	13.8	12.7	11.1	9.1	11	11.4	10.7	8.9	9	10	10.2	8.7	7.3	7.8	8	7	5.4	5.4	5.1	4.5	3.2	3.6			165
170	13.2	12.2	10.8	9	10.5	10.8	10.5	8.8	8.3	9.4	9.9	8.6	6.8	7.5	7.7	6.9	5	5.1	4.9	4.4	2.8	3.3			170
175	12.6	11.6	10.5	8.8	10.1	10.3	10.2	8.7	7.7	8.9	9.6	8.4	6.3	7.1	7.4	6.8	4.7	4.9	4.8	4.3	2.4	3			175
180	12.1	11.1	10.2	8.7	9.6	9.7	10	8.5	7.3	8.3	9.1	8.3	5.1	6.7	7.1	6.7	4.3	4.7	4.6	4.2	2.1	2.7			180
185	11.5	10.8	9.9	8.6	9.1	9.3	9.8	8.4	6.9	7.7	8.6	8.2	4.8	6.3	6.8	6.6	4	4.4	4.4	4.1	1.8	2.4			185
190	10.9	10.4	9.7	8.4	8.7	8.9	9.4	8.3	6.6	7.2	8.2	8.1	4.5	5.9	6.5	6.4		4.1	4.2	4		2.1			190
195	10.3	10	9.5	8.3	8.2	8.5	9	8.1	6.2	6.6	7.7	8	4.2	5.5	6.2	6.3		3.8	4	3.9		1.8			195
200	9.8	9.7	9.3	8.2	7.8	8.1	8.4	8	5.9	6.1	7.2	7.9	4	4.1	5.8	6.1		3.5	3.8	3.8					200
205	9.2	9.3	9.1	8.1	7.3	7.7	7.9	7.8	5.5	5.8	6.7	7.8	3.7	3.9	5.5	6		3.6	3.7						205
210	8.7	8.9	8.9	8	6.9	7.3	7.6	7.6	5.2	5.5	6.1	7.5	3.5	3.7	5.2	5.8				3.5					210
215	8.2	8.6	8.7	7.8	6.4	6.9	7.2	7.4	4.9	5.2	5.5	7	3.1	3.4	4.8	5.7				3.4					215
220	7.8	8.2	8.5	7.7	5.9	6.4	6.8	7.2	4.5	4.8	5.2	6.5	2.8	3.2	4.3	5.3				3.3					220
225	7.3	7.8	8.1	7.7	5.5	6	6.5	7	4.2	4.5	4.9	5.9	2.4	2.8	3.8	4.9				3.1					225
230	6.9	7.3	7.7	7.6	5.1	5.6	6.1	6.7	3.8	4.2	4.6	5.4	2.1	2.5	3.3	4.5				2.8					230
235	6.4	6.9	7.3	7.5	4.8	5.2	5.7	6.4	3.5	3.9	4.4	4.9	1.7	2.2	2.6	4.1				2.5					235
240	6	6.4	6.8	7.3	4.4	4.8	5.3	6	3.1	3.6	4.1	4.6		1.9	2.1	2.8				2.2					240
245	5.5	6	6.4	7	4	4.5	4.9	5.6	2.7	3.3	3.8	4.3		1.6		2.6									245
250	5.1	5.6	6	6.6	3.6	4.1	4.5	5.3	2.3	2.9	3.5	4				2.3									250
255	4.6	5.1	5.6	6.2	3.2	3.7	4.1	4.9	1.9	2.6	3.1	3.7				2									255
260	4.3	4.7	5.1	5.8	2.9	3.3	3.8	4.4		2.1	2.8	3.4				1.7									260
265	3.9	4.3	4.7	5.3		2.9	3.4	4		1.7	2.3	3.1													265
270	3.6	4	4.3	4.8			3	3.6				1.8				2.7									270
275	3.2	3.6	3.9	4.3			2.6	3.2								2.2									275
280	2.9	3.2	3.5	3.8			2.1	2.7								1.6									280
285	2.5	2.9	3.1	3.3			1.6	2.2																	285
290	2.1	2.5	2.7	2.8				1.6																	290
295	1.7	2.1	2.3																						295
300		1.6	1.8																						300

* adapter - piece d'adaptateur

Lifting capacities

Forces de levage

TF 138

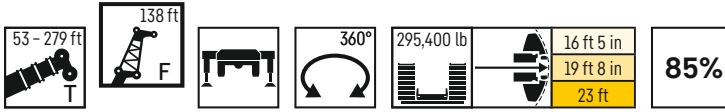

	53 ft + 7 ft 7 in*				122 ft + 7 ft 7 in*				139 ft + 7 ft 7 in*				157 ft + 7 ft 7 in*				174 ft + 7 ft 7 in*					
	138 ft																					
	0°	10°	20°	40°	0°	10°	20°	40°	0°	10°	20°	40°	0°	10°	20°	40°	0°	10°	20°	40°		
30	50																				30	
32	48.5																				32	
34	46.9																				34	
36	45.3																				36	
38	43.7																				38	
40	42.2																				40	
45	38.9				37.1				35.1												45	
50	36.2				35.2				33.5				31.2								50	
55	33.4	29.5			33.2				31.9				29.9					27.7			55	
60	30.8	27.7			31.5				30.3				28.7					26.8			60	
65	28.8	25.9			30				28.8				27.4					26			65	
70	26.9	24.2			28.6	25			27.6	24			26.2					25.2			70	
75	25.1	22.5			27.1	23.9			26.5	23.2			25.2	22.1				24.4			75	
80	23.3	20.9	19.6		25.7	22.8			25.3	22.3			24.3	21.4				23.6			80	
85	21.7	19.4	18.2		24.3	21.8			24.1	21.3			23.3	20.6				22.9	19.5		85	
90	20.3	18.2	17		23.3	20.9	18		22.9	20.5			22.4	19.8				22.1	18.9		90	
95	19	16.9	15.9		22.4	20	17.2		22	19.7	17		21.4	19.1				21.3	18.2		95	
100	17.7	15.7	14.9		21.4	19.1	16.3		21.2	19	16.2		20.5	18.4	15.9			20.5	17.6		100	
105	16.4	14.7	13.9		20.4	18.3	15.6		20.3	18.2	15.5		19.8	17.8	15.3			19.8	17.1	14.7	105	
110	15.2	13.8	13.1		19.4	17.5	14.9		19.5	17.5	14.8		19.1	17.2	14.7			19	16.5	14.3	110	
115	14	13	12.3	10	18.5	16.7	14.2		18.7	16.8	14.2		18.4	16.6	14.1			18.5	16	13.7	115	
120	13.1	12.2	11.5	9.5	17.6	15.9	13.5		17.8	16.1	13.6		17.7	15.9	13.5			17.9	15.5	13.2	120	
125	12.4	11.5	10.9	9.2	16.9	15.1	12.9		17	15.4	13		17	15.3	13			17.3	15	12.7	125	
130	11.7	10.7	10.4	8.8	16.1	14.3	12.4	9.3	16.4	14.7	12.5	9.3	16.4	14.8	12.4			16.8	14.5	12.3	130	
135	11	10	9.9	8.5	15.4	13.7	11.8	9.1	15.7	14	12	9.1	15.7	14.2	11.9	9.1		16.2	14	11.8	135	
140	10.3	9.6	9.4	8.2	14.7	13.2	11.3	8.8	15.1	13.4	11.5	8.9	15.1	13.6	11.5	8.9		15.7	13.5	11.4	8.8	140
145	9.6	9.1	8.9	7.9	13.9	12.7	10.9	8.6	14.5	12.9	11.1	8.7	14.6	13	11.2	8.7		15.1	13	11	8.7	145
150	9.1	8.7	8.5	7.6	13.1	12.1	10.5	8.4	13.8	12.4	10.7	8.5	14	12.5	10.8	8.5		14.5	12.5	10.7	8.5	150
155	8.7	8.2	8.2	7.4	12.4	11.6	10.1	8.2	13.2	12	10.3	8.3	13.5	12	10.4	8.3		13.9	12	10.4	8.3	155
160	8.3	7.8	7.8	7.1	11.8	11.1	9.8	8	12.5	11.6	10	8.1	13	11.6	10.1	8.1		13.5	11.5	10.1	8.1	160
165	7.9	7.5	7.4	6.9	11.4	10.6	9.5	7.8	11.9	11.1	9.7	7.9	12.5	11.3	9.8	7.9		13.1	11.1	9.8	7.9	165
170	7.4	7.2	7.1	6.7	11	10.1	9.1	7.6	11.4	10.7	9.4	7.7	12	10.9	9.5	7.7		12.6	10.7	9.5	7.7	170
175	7.1	6.9	6.8	6.5	10.5	9.7	8.8	7.4	10.9	10.2	9.1	7.5	11.5	10.5	9.2	7.6		12.2	10.4	9.2	7.5	175
180	6.8	6.6	6.6	6.3	10.1	9.4	8.5	7.2	10.6	9.8	8.8	7.4	10.9	10.2	9	7.4		11.7	10.1	9	7.4	180
185	6.5	6.4	6.3		9.7	9.1	8.3	7.1	10.2	9.4	8.5	7.2	10.4	9.8	8.7	7.3		11.3	9.8	8.8	7.2	185
190	6.3	6.2	6.3		9.3	8.8	8	6.9	9.9	9.2	8.3	7	10.1	9.5	8.5	7.1		10.9	9.5	8.6	7.1	190
195					8.9	8.5	7.8	6.8	9.5	8.9	8.1	6.9	9.8	9.1	8.2	6.9		10.4	9.3	8.3	7	195
200					8.5	8.2	7.5	6.6	9.2	8.6	7.8	6.7	9.5	8.8	8	6.8		10	9	8.1	6.8	200
205					8.3	7.9	7.3	6.5	8.8	8.4	7.6	6.6	9.2	8.6	7.8	6.7		9.6	8.7	7.9	6.7	205
210					8	7.7	7.1	6.4	8.5	8.1	7.4	6.5	8.9	8.4	7.6	6.6		9.3	8.4	7.7	6.6	210
215					7.7	7.5	6.9	6.3	8.2	7.8	7.2	6.4	8.6	8.1	7.4	6.5		8.9	8.2	7.4	6.5	215
220					7.5	7.2	6.8	6.2	7.9	7.6	7	6.3	8.3	7.9	7.2	6.4		8.5	8	7.3	6.4	220
225					7.2	7	6.6	6.2	7.7	7.4	6.8	6.2	8	7.7	7.1	6.3		8.2	7.8	7.1	6.3	225
230					6.9	6.8	6.4	6.2	7.5	7.2	6.7	6.2	7.7	7.5	6.9	6.2		7.8	7.5	7	6.2	230
235					6.7	6.6	6.3	6.2	7.2	7	6.6	6.1	7.5	7.2	6.7	6.2		7.5	7.3	6.8	6.1	235
240					6.5	6.4	6.2	6.2	7	6.8	6.4	6.1	7.3	7.1	6.6	6.1		7.1	7.1	6.7	6.1	240
245					6.3	6.3	6.1		6.8	6.6	6.3	6.1	7.1	6.9	6.5	6		6.7	6.9	6.5	6	245
250					6.2	6.2	6		6.5	6.4	6.2	6.1	6.9	6.8	6.3	6		6.4	6.7	6.4	6	250
255					6	6	6		6.4	6.3	6.1	6.1	6.8	6.6	6.2	6		6	6.4	6.1	6	255
260					6	6			6.3	6.2	6		6.6	6.5	6.1	6		5.6	6	5.8	5.9	260
265									6.1	6.1	6		6.4	6.3	6	6		5.3	5.6	5.5	5.8	265
270									6	6	6		6.2	6.2	6	6		4.9	5.2	5.3	5.7	270
275									5.9	6			6	6.1	6			4.5	4.8	5	5.5	275
280													5.9	6	5.9			4.1	4.4	4.7	5.1	280
285													5.7	6	5.9			3.8	4	4.3	4.5	285
290													4.6	5.9	5.9			3.4	3.7	3.9		290
295														2.5				3	3.3	3.5		295
300																		2.7	2.9	3.1		300
305																			2.5	2.6		305

* adapter - piece d'adaptateur

Lifting capacities

Forces de levage

TF 138

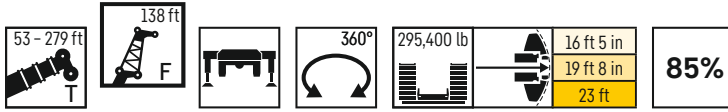

	191 ft + 7 ft 7 in*				209 ft + 7 ft 7 in*				226 ft + 7 ft 7 in*				243 ft + 7 ft 7 in*				261 ft + 7 ft 7 in*				276 ft + 7 ft 7 in*		279 ft+		
	0°	10°	20°	40°	0°	10°	20°	40°	0°	10°	20°	40°	0°	10°	20°	40°	0°	10°	20°	40°	0°	10°	0°		
60	24.5																						60		
65	23.8																							65	
70	23				20.3																			70	
75	22.3				19.7					16.6														75	
80	21.6				19.2					16.1				12.2										80	
85	20.9				18.7					15.6				11.9				8.2						85	
90	20.3	17.6			18.1					15.2				11.5				7.9				4.1		3.5	90
95	19.7	17.1			17.6					14.7				11.2				7.7				4.1		3.4	95
100	19.1	16.6			17.2	15.2				14.2				10.8				7.4				4.1		3.4	100
105	18.5	16.1			16.8	14.8				13.8	13.3			10.5				7.1				4.1		3.4	105
110	17.9	15.6			16.3	14.4				13.4	13			10.1	9.9			6.9				4		3.4	110
115	17.4	15.1	13.2		15.9	14				12.9	12.6			9.8	9.7			6.6	6.1			3.9		3.4	115
120	16.8	14.7	12.7		15.5	13.6	11.9			12.5	12.3			9.4	9.4			6.3	5.9			3.9		3.4	120
125	16.2	14.2	12.3		15	13.2	11.5			12.1	11.9			9.1	9.1			6.1	5.7			3.8	3.7	3.4	125
130	15.6	13.8	11.8		14.6	12.8	11.2			11.7	11.5	10.4		8.7	8.8			5.9	5.5			3.6	3.6	3.2	130
135	15	13.4	11.5		14.1	12.5	10.9			11.3	11.1	10.2		8.4	8.5	5.1		5.6	5.3			3.3	3.3	3	135
140	14.5	12.9	11.1		13.4	12.1	10.6			10.8	10.8	10		8.1	8.2	7.7		5.4	5.1	4.4		3.1	3.1	2.6	140
145	14.1	12.6	10.8		12.7	11.7	10.3			10.3	10.4	9.7		7.7	7.9	7.6		5.2	4.9	4.3		2.8	2.9	2.3	145
150	13.6	12.2	10.5	8.3	11.9	11.3	10			9.8	10	9.5		7.4	7.5	7.4		4.9	4.7	4.2		2.5	2.7	2	150
155	13.2	11.8	10.1	8.1	11.2	10.9	9.8	7.9		9.2	9.7	9.2		7	7.2	7.2		4.7	4.5	4		2.2	2.5	1.7	155
160	12.7	11.4	9.9	7.9	10.4	10.5	9.5	7.7	8.6	9.3	9			6.6	6.9	7		4.5	4.3	3.8			2.2		160
165	12.2	11.1	9.6	7.8	9.7	10	9.3	7.5	8	8.9	8.8	7.3		6.2	6.6	6.7		4.2	4.1	3.6			2		165
170	11.8	10.7	9.4	7.6	9.2	9.6	9.1	7.4	7.4	8.4	8.5	7.2		5.7	6.3	6.4	2.9	3.8	3.8	3.4					170
175	11.3	10.3	9.1	7.4	8.8	9.1	8.8	7.3	6.4	7.9	8.3	7.1		5.3	6	6.2	5.5	3.4	3.6	3.3			1.8		175
180	10.8	9.9	8.9	7.3	8.4	8.6	8.6	7.1	6.1	7.4	8	6.9		4.9	5.6	5.9	5.4	3	3.3	3.1	2.4				180
185	10.3	9.4	8.7	7.2	8	8.2	8.4	7	5.8	6	7.6	6.8			5.3	5.6	5.3	2.6	3.1	2.9	2.3				185
190	9.8	9.1	8.3	7	7.5	7.8	8.2	6.9	5.4	5.6	7.2	6.7			4.9	5.4	5.2	2.2	2.8	2.7	2.2				190
195	9.3	8.8	8.1	6.9	7.1	7.4	8	6.8	5.1	5.3	6.8	6.6			4.5	5.1	5.1	1.8	2.4	2.5	2				195
200	8.8	8.5	7.9	6.8	6.7	7	7.7	6.7	4.8	5	6.4	6.5			4.1	4.8	5		2.1	2.3	2				200
205	8.3	8.1	7.8	6.7	6.3	6.6	7.4	6.5	4.5	4.7	6	6.4				4.5	4.9		1.8	2.1	1.9				205
210	7.8	7.8	7.6	6.6	5.9	6.3	6.7	6.4	4.2	4.4	5.6	6.3				2.2	4.7				1.9	1.8			210
215	7.3	7.5	7.4	6.5	5.5	5.9	6.2	6.2	3.8	4.1	5.1	6.2				2	4.5				1.7	1.7			215
220	6.8	7.2	7.2	6.4	5	5.5	5.9	6	3.5	3.8	4.5	6.1				1.8	4.3					1.6			220
225	6.4	6.9	7.1	6.2	4.6	5.2	5.5	5.8	3.2	3.6	4	5.6				1.6	4.1								225
230	6	6.5	6.9	6.1	4.2	4.8	5.2	5.7		3.3	3.6	5.1					3.9								230
235	5.6	6.1	6.5	6.1	3.8	4.4	4.9	5.5		2.9	3.4	4.6					3.5								235
240	5.2	5.7	6.1	6	3.5	4	4.6	5.2		2.6	3.1	4.1					3.1								240
245	4.8	5.3	5.7	6	3.1	3.7	4.2	4.9		2.2		3.5					2.6								245
250	4.3	4.9	5.3	5.9	2.7	3.3	3.8	4.6				3.1													250
255	3.9	4.5	4.9	5.5	2.3	2.9	3.5	4.2				2.9													255
260	3.5	4.1	4.5	5.1	1.8	2.5	3.1	3.9				2.6													260
265	3.1	3.7	4.1	4.8		2	2.7	3.5				2.2													265
270	2.8	3.3	3.7	4.4		1.6		3.1				1.8													270
275	2.4	2.9	3.3	4				2.7																	275
280	2	2.5	2.9	3.5				2.2																	280
285	1.6	2.1	2.5	3				1.6																	285
290		1.6	2	2.5																					290
295				1.9																					295

* adapter - piece d'adaptateur

Lifting capacities

Forces de levage

TF 149

53 - 276 ft
149 ft
360°
295,400 lb
16 ft 5 in
19 ft 8 in
23 ft
85%

	53 ft + 7 ft 7 in*				122 ft + 7 ft 7 in*				139 ft + 7 ft 7 in*				157 ft + 7 ft 7 in*				174 ft + 7 ft 7 in*				
	0°	10°	20°	40°	0°	10°	20°	40°	0°	10°	20°	40°	0°	10°	20°	40°	0°	10°	20°	40°	
32	43.7																				32
34	42.4																				34
36	41.1																				36
38	39.9																				38
40	38.6																				40
45	35.5				33.3																45
50	33.1				31.6				29.9							27.9					50
55	30.8				29.9				28.6							27					55
60	28.6	26.5			28.3				27.2							26.1				24.4	60
65	26.4	24.9			26.9				25.9							25.2				23.6	65
70	24.8	23.2			25.7				24.7							24.3				22.7	70
75	23.3	21.7			24.5	21.5			23.7	20.8						23.4				21.9	75
80	21.7	20.3			23.2	20.6			22.7	20						22.6	19.1			21	80
85	20.1	18.9	17		22	19.6			21.7	19.2						21.7	18.4			20.3	85
90	18.8	17.5	15.8		21	18.8			20.7	18.3						20.9	17.7			19.7	90
95	17.5	16.5	14.7		20.1	18			19.7	17.6						20	17			19	95
100	16.4	15.4	13.8		19.2	17.3	14.8		18.9	17	14.5					19.2	16.4			18.3	100
105	15.3	14.3	12.9		18.4	16.5	14		18.2	16.3	13.9					18.4	15.8	13.6		17.6	105
110	14.2	13.3	12		17.6	15.8	13.3		17.5	15.7	13.3					17.8	15.3	13.1		17	110
115	13.1	12.4	11.3		16.7	15.1	12.7		16.8	15	12.7					17.2	14.7	12.5		16.3	115
120	12.1	11.8	10.7		15.9	14.4	12.1		16	14.4	12.2					16.6	14.2	12		15.8	120
125	11.2	11.2	10.2	8.3	15.2	13.7	11.5		15.3	13.8	11.6					16	13.6	11.5		15.3	125
130	10.7	10.5	9.6	8	14.6	13	11		14.6	13.2	11.1					15.4	13.1	11.1		14.9	130
135	10.1	9.9	9.1	7.6	13.9	12.3	10.6	8	14.1	12.6	10.7					14.8	12.7	10.7		14.4	135
140	9.6	9.3	8.7	7.3	13.3	11.7	10.2	7.7	13.5	12	10.3	7.7				14.2	12.2	10.3		13.9	140
145	9	8.8	8.3	7	12.7	11.2	9.8	7.5	13	11.5	9.9	7.5				13.6	11.7	9.9	7.5	13.4	145
150	8.5	8.3	7.9	6.8	12	10.8	9.4	7.3	12.5	11	9.6	7.3				13.1	11.2	9.6	7.3	12.9	150
155	8	7.9	7.4	6.5	11.4	10.4	9.1	7.1	12	10.5	9.2	7.1				12.7	10.7	9.3	7.2	12.4	155
160	7.6	7.5	7.1	6.3	10.8	10	8.8	6.9	11.4	10.2	8.9	7				12.3	10.2	9	7	11.9	160
165	7.3	7.1	6.8	6.1	10.2	9.6	8.5	6.7	10.9	9.9	8.6	6.8				11.8	9.9	8.7	6.8	11.5	165
170	6.9	6.7	6.4	5.8	9.8	9.2	8.2	6.6	10.4	9.5	8.3	6.6				11.4	9.6	8.4	6.7	11.2	170
175	6.5	6.4	6.2	5.6	9.4	8.8	7.9	6.4	9.9	9.2	8.1	6.5				10.9	9.3	8.2	6.5	10.8	175
180	6.2	6.2	5.9	5.4	9.1	8.4	7.6	6.2	9.5	8.8	7.8	6.3				10.5	9.1	7.9	6.4	10.5	180
185	5.9	5.9	5.6	5.3	8.7	8.1	7.3	6.1	9.1	8.5	7.6	6.2				10	8.8	7.7	6.2	10.1	185
190	5.6	5.6	5.4	5.2	8.4	7.9	7.1	5.9	8.8	8.2	7.3	6				9.6	8.5	7.5	6.1	9.8	190
195	5.3	5.4	5.2	5.1	8	7.6	6.8	5.8	8.5	7.9	7.1	5.9				9.2	8.2	7.2	5.9	9.4	195
200	5.1	5.1	5.1		7.7	7.3	6.6	5.7	8.2	7.6	6.8	5.7				8.9	7.9	7	5.8	9.1	200
205					7.3	7.1	6.4	5.5	7.9	7.4	6.6	5.6				8.6	7.6	6.8	5.7	8.7	205
210					7.1	6.8	6.2	5.4	7.6	7.2	6.5	5.5				8.3	7.3	6.6	5.5	8.4	210
215					6.8	6.5	6	5.3	7.3	6.9	6.3	5.4				8.1	7.1	6.4	5.4	8	215
220					6.6	6.3	5.8	5.2	7	6.7	6.1	5.3				7.8	6.9	6.2	5.3	7.7	220
225					6.3	6.1	5.6	5.1	6.7	6.5	5.9	5.2				7.5	6.7	6.1	5.2	7.4	225
230					6.1	5.9	5.5	5	6.5	6.2	5.7	5.1				7.3	6.5	5.9	5.1	7.1	230
235					5.9	5.7	5.3	5	6.3	6.1	5.6	5				7	6.3	5.8	5.1	6.8	235
240					5.6	5.5	5.2	5	6.1	5.9	5.5	5				6.7	6.1	5.6	5	6.5	240
245					5.4	5.4	5.1	5	5.9	5.7	5.3	4.9				6.6	5.9	5.5	5	6.2	245
250					5.3	5.2	5	5	5.7	5.6	5.2	4.9				6.4	5.8	5.3	4.9	5.8	250
255					5.1	5.1	4.9	5	5.5	5.4	5.1	4.9				6.2	5.6	5.2	4.9	5.5	255
260					5	5	4.8		5.3	5.2	5	4.9				6	5.5	5.1	4.9	5.2	260
265					4.8	4.9	4.8		5.2	5.1	4.9	4.9				5.8	5.4	5	4.9	4.9	265
270					4.8	4.9			5	5	4.8	4.9				5.6	5.2	4.9	4.9	4.5	270
275									4.9	4.9	4.8					5.4	5.1	4.8	4.9	4.2	275
280									4.8	4.8	4.8					5.3	5	4.8	4.9	3.8	280
285									4.7	4.8	4.8					5.1	4.9	4.8	4.9	3.5	285
290																5	4.8	4.7		3.2	290
295																4.8	4.8	4.7		2.8	295
300																4.5	4.7	4.7		2.5	300
305																	3.7			2.1	305
310																				1.7	310
315																				2	315

* adapter - piece d'adaptateur

Lifting capacities

Forces de levage

TF 149

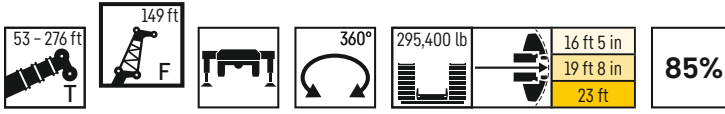

	191 ft + 7 ft 7 in*				209 ft + 7 ft 7 in*				226 ft + 7 ft 7 in* 149 ft				243 ft + 7 ft 7 in*				261 ft + 7 ft 7 in*			276 ft + 7 ft 7 in	
	0°	10°	20°	40°	0°	10°	20°	40°	0°	10°	20°	40°	0°	10°	20°	40°	0°	10°	20°	0°	
65	21.1				17.9																65
70	20.5																				70
75	19.9				17.5				12.6												75
80	19.2				17				14.5				8.1								80
85	18.6				16.5				14.1				10.5								85
90	18				16				13.7				10.2				6.6			2.6	90
95	17.5	15.1			15.6				13.3				9.9				6.4			2.6	95
100	17	14.6			15.2				12.8				9.6				6.2			2.5	100
105	16.4	14.2			14.8	12.9			12.4				9.2				5.9			2.5	105
110	15.9	13.7			14.4	12.6			12	11.3			8.9				5.7			2.5	110
115	15.4	13.3			14	12.2			11.6	11.1			8.6	5.4			5.4			2.4	115
120	14.9	12.9	11.1		13.6	11.9			11.3	10.8			8.3	8			5.2	4.4		2.4	120
125	14.4	12.5	10.8		13.2	11.5			10.9	10.5			8	7.8			5	4.2		2.4	125
130	13.9	12.1	10.5		12.8	11.3	9.9		10.5	10.3			7.7	7.6			4.7	4.1		2.3	130
135	13.5	11.7	10.2		12.5	11	9.7		10.1	10	7		7.4	7.4			4.5	3.9		2.2	135
140	13	11.4	9.9		12	10.7	9.4		9.7	9.7	8.8		7.1	7.1	3.5		4.3	3.7		2	140
145	12.6	11	9.6		11.4	10.4	9.1		9.4	9.3	8.5		6.8	6.9	6.2		4	3.5		1.8	145
150	12.1	10.7	9.3		10.8	10.1	8.9		8.9	9	8.3		6.5	6.6	6		3.8	3.3	2.6	1.6	150
155	11.7	10.4	9		10.2	9.8	8.6		8.4	8.7	8.1		6.1	6.3	5.9		3.5	3.1	2.5		155
160	11.3	10.1	8.7	6.9	9.6	9.5	8.4		7.9	8.3	7.9		5.8	6.1	5.7		3.3	2.9	2.3		160
165	10.9	9.8	8.5	6.7	9	9.1	8.2	6.5	7.4	8	7.7		5.5	5.8	5.5		3	2.7	2.2		165
170	10.5	9.5	8.3	6.5	8.4	8.7	8	6.4	6.9	7.6	7.5		5.1	5.5	5.4		2.8	2.5	2		170
175	10.1	9.2	8	6.4	7.9	8.3	7.8	6.2	6.3	7.2	7.3	6	4.7	5.2	5.2		2.4	2.3	1.9		175
180	9.7	8.9	7.8	6.2	7.6	8	7.6	6.1	5.8	6.8	7.1	5.9	4.3	4.9	5		2.1	2.1	1.8		180
185	9.3	8.6	7.6	6.1	7.2	7.6	7.4	6	5	6.4	6.8	5.8	3.9	4.6	4.8	4.2	1.8	1.9	1.7		185
190	8.9	8.2	7.4	6	6.8	7.2	7.2	5.8	4.7	5.9	6.6	5.7		4.3	4.6	4.1		1.8	1.6		190
195	8.4	7.9	7.2	5.8	6.4	6.7	7	5.7	4.4	5.5	6.2	5.6		4	4.4	4		1.6			195
200	8	7.6	6.9	5.7	6.1	6.3	6.8	5.6	4.1	5	5.9	5.5		3.6	4.1	3.9					200
205	7.6	7.3	6.7	5.6	5.7	5.9	6.6	5.5	3.8	4.1	5.5	5.3		3.2	3.9	3.9					205
210	7.2	7	6.6	5.5	5.3	5.6	6.4	5.4	3.5	3.8	5.1	5.3		2.8	3.6	3.8					210
215	6.8	6.7	6.4	5.4	4.9	5.3	6	5.3	3.2	3.5	3.7	5.2			3.4	3.7					215
220	6.4	6.5	6.3	5.3	4.6	5	5.4	5.2	2.8	3.2	3.5	5.1				3.5					220
225	5.9	6.2	6.1	5.2		4.6	4.9	5	2.4	2.9	3.2	5				3.4					225
230	5.5	5.9	5.9	5.1		4.3	4.6	4.9	2	2.5	3	4.9				3.2					230
235	5.2	5.6	5.8	5		4	4.3	4.7	1.7	2.2	2.7	4.5				3.1					235
240	4.8	5.3	5.6	4.9		3.7	4.1	4.5		1.9	2.3	4.1				2.8					240
245	4.4	4.9	5.3	4.9			3.8	4.3			2	3.6				2.4					245
250	4	4.6	4.9	4.8			3.5	4.1			1.7	2.5				2					250
255	3.6	4.2	4.6	4.8			3.2	3.8				2.2									255
260	3.2	3.8	4.2	4.7			2.8	3.5				1.9									260
265	2.9	3.4	3.9	4.4			2.4	3.2				1.5									265
270		3.1	3.5	4.1			1.9	2.9													270
275			3.1	3.8				2.5													275
280			2.7	3.4				2.1													280
285			2.3	3																	285
290			1.8	2.6																	290
295				2																	295

* adapter - piece d'adaptateur

Lifting capacities

Forces de levage

TF 161

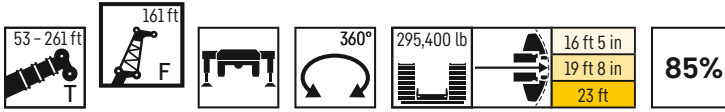

	53 ft + 7 ft 7 in*				122 ft + 7 ft 7 in*				139 ft + 7 ft 7 in*				157 ft + 7 ft 7 in*				174 ft + 7 ft 7 in*				
	0°	10°	20°	40°	0°	10°	20°	40°	0°	10°	20°	40°	0°	10°	20°	40°	0°	10°	20°	40°	
34	38.6																				34
36	37.5																				36
38	36.5																				38
40	35.4																				40
45	32.6				29.8																45
50	30.2				28.4				27.4												50
55	28.3				27				26.3				24.7								55
60	26.3				25.5				25.2				23.8				21.7				60
65	24.4	22.9			24.2				24.1				22.8				20.9				65
70	22.6	21.5			23.1				23.1				21.8				20.2				70
75	21.3	20.1			22	19.2			22.2				20.9				19.4				75
80	20	18.8			20.9	18.5			21.2	17.8			20.1				18.7				80
85	18.6	17.5			19.9	17.6			20.3	17.1			19.3	16.3			17.9				85
90	17.3	16.3	14.5		18.9	16.8			19.4	16.4			18.6	15.7			17.4	14.6			90
95	16.1	15	13.5		18	16.1			18.5	15.7			17.8	15.1			16.8	14.2			95
100	15.1	14.1	12.6		17.3	15.4			17.7	15			17.1	14.5			16.2	13.7			100
105	14.1	13.2	11.8		16.6	14.7	12.5		17	14.4			16.4	13.9			15.6	13.2			105
110	13.2	12.3	11.1		15.9	14.1	11.8		16.3	13.9	11.8		15.7	13.4			15	12.7			110
115	12.3	11.4	10.4		15.2	13.4	11.2		15.7	13.3	11.2		15.1	12.9	11		14.4	12.3			115
120	11.4	10.6	9.8		14.4	12.8	10.7		15	12.7	10.7		14.6	12.4	10.6		13.9	11.9	10.2		120
125	10.5	10	9.3		13.7	12.2	10.3		14.4	12.2	10.3		14.1	11.9	10.2		13.4	11.5	9.9		125
130	9.6	9.5	8.8		13.1	11.7	9.9		13.7	11.7	9.9		13.5	11.5	9.8		13	11.1	9.5		130
135	9.2	9	8.3	6.7	12.6	11.1	9.4		13.1	11.2	9.5		13	11	9.5		12.5	10.7	9.2		135
140	8.7	8.5	7.8	6.4	12.1	10.5	9.1		12.6	10.8	9.1		12.5	10.6	9.1		12.1	10.3	8.9		140
145	8.2	8	7.4	6.1	11.6	10	8.7	6.4	12.1	10.3	8.8		12	10.3	8.8		11.7	9.9	8.6		145
150	7.7	7.5	7	5.8	11.1	9.6	8.4	6.2	11.6	9.8	8.5	6.2	11.5	9.9	8.4		11.2	9.6	8.3		150
155	7.3	7.1	6.7	5.6	10.6	9.2	8	6	11.2	9.4	8.2	6	11.1	9.5	8.2	6	10.8	9.3	8		155
160	6.8	6.7	6.3	5.3	10	8.9	7.7	5.8	10.7	9	7.8	5.8	10.7	9.1	7.9	5.9	10.3	9	7.8	5.8	160
165	6.4	6.4	5.9	5.1	9.5	8.5	7.4	5.7	10.3	8.7	7.5	5.7	10.3	8.8	7.6	5.7	9.9	8.7	7.5	5.7	165
170	6.1	6	5.6	4.9	9	8.2	7.1	5.5	9.8	8.4	7.3	5.5	10	8.5	7.3	5.5	9.5	8.4	7.3	5.5	170
175	5.8	5.7	5.3	4.7	8.6	7.8	6.9	5.3	9.4	8.1	7	5.4	9.6	8.2	7.1	5.4	9.3	8	7	5.4	175
180	5.4	5.3	5.1	4.5	8.2	7.5	6.6	5.2	8.9	7.8	6.8	5.2	9.2	7.9	6.8	5.2	9	7.7	6.8	5.2	180
185	5.1	5.1	4.8	4.4	7.9	7.1	6.3	5	8.5	7.5	6.5	5.1	8.9	7.6	6.6	5.1	8.7	7.5	6.6	5.1	185
190	4.8	4.8	4.6	4.2	7.6	6.8	6.1	4.9	8.1	7.2	6.3	4.9	8.5	7.4	6.4	5	8.4	7.2	6.4	5	190
195	4.5	4.5	4.3	4	7.3	6.6	5.8	4.7	7.8	6.9	6.1	4.8	8.1	7.1	6.2	4.8	8.1	7	6.1	4.8	195
200	4.3	4.3	4.1	3.9	7	6.3	5.6	4.6	7.6	6.6	5.8	4.7	7.8	6.8	6	4.7	7.8	6.7	5.9	4.7	200
205	4.1	4.1	3.9	3.8	6.7	6.1	5.4	4.4	7.3	6.3	5.6	4.5	7.4	6.6	5.8	4.6	7.5	6.5	5.8	4.6	205
210	3.8	3.9	3.8		6.4	5.8	5.2	4.3	7	6.1	5.4	4.4	7.2	6.3	5.6	4.5	7.2	6.3	5.6	4.5	210
215	3.7	3.7			6.1	5.6	5	4.2	6.7	5.9	5.2	4.3	6.9	6.1	5.4	4.3	6.9	6.1	5.4	4.4	215
220					5.8	5.3	4.8	4.1	6.4	5.7	5.1	4.2	6.7	5.8	5.2	4.2	6.6	5.8	5.2	4.2	220
225					5.6	5.1	4.6	4	6.2	5.5	4.9	4.1	6.4	5.6	5	4.1	6.3	5.6	5	4.1	225
230					5.4	4.9	4.5	3.9	5.9	5.3	4.7	4	6.2	5.4	4.8	4	6	5.4	4.8	4	230
235					5.2	4.8	4.3	3.8	5.7	5.1	4.5	3.9	5.9	5.2	4.7	3.9	5.7	5.2	4.6	4	235
240					5	4.6	4.2	3.7	5.4	4.9	4.4	3.8	5.7	5.1	4.5	3.9	5.4	5	4.5	3.9	240
245					4.7	4.4	4.1	3.7	5.2	4.7	4.3	3.8	5.5	4.9	4.4	3.8	5.2	4.9	4.4	3.8	245
250					4.5	4.2	3.9	3.7	5	4.5	4.1	3.7	5.2	4.7	4.2	3.7	4.9	4.7	4.2	3.7	250
255					4.3	4.1	3.8	3.7	4.8	4.4	4	3.6	5	4.5	4.1	3.7	4.6	4.5	4.1	3.7	255
260					4.1	3.9	3.7	3.7	4.6	4.2	3.9	3.6	4.9	4.3	3.9	3.6	4.3	4.3	4	3.6	260
265					3.8	3.8	3.6	3.7	4.4	4.1	3.8	3.6	4.7	4.2	3.8	3.6	4	4.2	3.9	3.6	265
270					3.7	3.7	3.6		4.2	3.9	3.6	3.6	4.5	4.1	3.7	3.5	3.7	4	3.7	3.5	270
275					3.5	3.6	3.5		4.1	3.8	3.6	3.6	4.4	3.9	3.6	3.5	3.4	3.8	3.6	3.5	275
280					3.4	3.5			3.9	3.7	3.5	3.6	4.2	3.8	3.5	3.5	3.1	3.5	3.3	3.5	280
285					2.1				3.8	3.6	3.5		4	3.7	3.4	3.5	2.7	3.1	3.1	3.4	285
290									3.7	3.5	3.5		3.9	3.5	3.4	3.5	2.4	2.8	2.8	3.2	290
295									3.5	3.4	3.4		3.7	3.5	3.4	3.5	2	2.5	2.6	3.1	295
300									2.8	3.4			3.5	3.4	3.4		1.6	2	2.4	2.8	300
305													3.4	3.4	3.4			1.6	2	2.3	305
310													3.2	3.3	3.4					1.9	310
315														3.2							315

* adapter - piece d'adaptateur

Lifting capacities

Forces de levage

TF 161

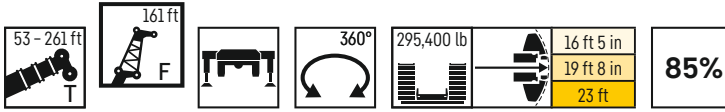

	191 ft + 7 ft 7 in*				209 ft + 7 ft 7 in*				226 ft + 7 ft 7 in*				243 ft + 7 ft 7 in*			261 ft + 7 ft 7 in*	
	0°	10°	20°	40°	0°	10°	20°	40°	0°	10°	20°	40°	0°	10°	20°	0°	
65	18.6																65
70	18.1																70
75	17.5				15.2												75
80	16.9				14.8				12.7								80
85	16.4				14.4				12.4				8.9				85
90	15.8				14				12				8.7			4.3	90
95	15.3				13.6				11.6				8.4			4.1	95
100	14.8	12.7			13.2				11.2				8.1			4	100
105	14.4	12.3			12.8				10.8				7.8			3.8	105
110	13.9	11.9			12.4	10.8			10.5				7.5			3.6	110
115	13.4	11.5			12.1	10.5			10.1	9.3			7.2			3.4	115
120	13	11.1			11.7	10.1			9.7	9.1			6.9	3.2		3.2	120
125	12.5	10.7	9.2		11.4	9.8			9.4	8.9			6.7	6.2		3	125
130	12.1	10.4	9		11	9.5			9.1	8.6			6.4	6.1		2.8	130
135	11.7	10.1	8.7		10.7	9.2	8		8.7	8.4			6.1	5.9		2.6	135
140	11.3	9.7	8.4		10.3	9	7.8		8.4	8.1			5.8	5.7		2.5	140
145	10.9	9.4	8.2		9.9	8.7	7.6		8	7.9	6.9		5.5	5.5		2.3	145
150	10.6	9.1	7.9		9.4	8.5	7.4		7.7	7.6	6.8		5.3	5.3	4.6	2.1	150
155	10.2	8.8	7.7		8.9	8.2	7.1		7.3	7.3	6.6		5	5.1	4.5	2	155
160	9.8	8.5	7.4		8.4	7.9	6.9		6.9	7	6.4		4.7	4.8	4.3	1.8	160
165	9.5	8.3	7.2		7.9	7.7	6.7		6.4	6.7	6.2		4.4	4.6	4.2		165
170	9.1	8	6.9	5.5	7.3	7.4	6.5		5.9	6.5	6		4	4.3	4		170
175	8.7	7.8	6.7	5.3	6.8	7	6.3		5.4	6.1	5.9		3.6	4.1	3.9		175
180	8.3	7.5	6.5	5.2	6.4	6.7	6.1	4.9	4.9	5.8	5.7		3.1	3.8	3.7		180
185	8	7.3	6.3	5	6	6.4	6	4.8	4.4	5.5	5.5	4.5	2.6	3.5	3.5		185
190	7.6	7	6.1	4.9	5.7	5.8	5.8	4.7		5.1	5.3	4.4	2.2	3.2	3.3		190
195	7.2	6.7	5.9	4.7	5.3	5.5	5.6	4.6		4.6	5.2	4.3		2.8	3.1		195
200	6.9	6.3	5.7	4.6	5	5.2	5.5	4.4		4.2	4.9	4.2		2.4	2.9		200
205	6.5	6.1	5.5	4.5	4.7	4.9	5.3	4.3		3.8	4.6	4.2		2	2.6		205
210	6.1	5.8	5.3	4.4	4.3	4.6	5.1	4.2			4.3	4.1		1.6	2.4		210
215	5.8	5.6	5.1	4.3	4	4.3	5	4.1			3.9	4			2.1		215
220	5.4	5.3	5	4.2	3.6	4	4.8	4				3.9			1.8		220
225	5	5.1	4.9	4.1	3.3	3.7	4.4	3.9				3.8					225
230	4.6	4.8	4.7	4	2.9	3.4	3.8	3.8				3.7					230
235	4.3	4.5	4.6	3.9		3	3.4	3.7				3.6					235
240	3.9	4.3	4.4	3.8		2.6	3.1	3.5				3.5					240
245	3.6	4	4.3	3.7		2.2	2.8	3.3				3.1					245
250	3.2	3.7	4.1	3.6		1.8	2.5	3.1				2.7					250
255	2.8	3.4	3.8	3.6				2.9				2.1					255
260	2.4	3.1	3.5	3.6				2.7									260
265	1.9	2.7	3.2	3.5				2.4									265
270		2.2	2.8	3.5				2									270
275		1.7		3.3				1.6									275
280				2.9													280
285				2.5													285
290				2													290

* adapter - piece d'adaptateur

Lifting capacities

Forces de levage

TF 172

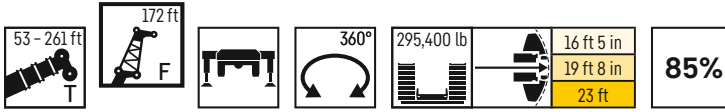

Height (ft)	53 ft + 7 ft 7 in*				122 ft + 7 ft 7 in*				139 ft + 7 ft 7 in*				157 ft + 7 ft 7 in*				174 ft + 7 ft 7 in*				Height (ft)
	172 ft																				
	0°	10°	20°	40°	0°	10°	20°	40°	0°	10°	20°	40°	0°	10°	20°	40°	0°	10°	20°	40°	
36	34.3																				36
38	33.4																				38
40	32.4																				40
45	30.1																				45
50	27.9				26.8				25												50
55	26				25.5				24.1				22.2								55
60	24.4				24.2				23				21.4						19.4		60
65	22.7				23				21.9				20.5						18.7		65
70	21.1	19.9			21.9				20.9				19.7						18.1		70
75	19.6	18.7			20.9				20				18.8						17.4		75
80	18.5	17.4			19.9	16.7			19.2				18.1						16.7		80
85	17.3	16.3			18.9	15.9			18.3	15.4			17.4						16.1		85
90	16.1	15.2			17.9	15.2			17.5	14.7			16.7	14					15.5		90
95	15	14.1			17	14.5			16.7	14.1			16	13.5					14.9	12.5	95
100	14	13	11.7		16.2	13.8			15.9	13.5			15.4	12.9					14.4	12.2	100
105	13.1	12.2	10.9		15.6	13.3			15.2	12.9			14.7	12.4					13.9	11.7	105
110	12.3	11.5	10.3		14.9	12.7	10.8		14.6	12.4			14	11.9					13.3	11.3	110
115	11.6	10.8	9.7		14.2	12.1	10.3		14	11.9	10.1		13.5	11.5					12.8	10.8	115
120	10.8	10	9.1		13.5	11.5	9.8		13.4	11.4	9.7		13	11	9.3				12.3	10.4	120
125	10.1	9.4	8.6		12.9	11	9.4		12.9	10.8	9.3		12.5	10.6	9				11.8	10.1	125
130	9.3	8.8	8.1		12.2	10.5	9		12.3	10.4	8.9		12	10.1	8.7				11.4	9.7	130
135	8.6	8.3	7.7		11.6	10.1	8.6		11.7	10	8.6		11.6	9.7	8.3				11	9.3	135
140	8	7.9	7.2		11.2	9.6	8.2		11.1	9.6	8.2		11.1	9.3	8				10.6	9	140
145	7.6	7.4	6.8	5.4	10.7	9.2	7.9		10.7	9.2	7.9		10.6	9	7.7				10.2	8.6	145
150	7.2	7	6.4	5.2	10.3	8.7	7.6		10.3	8.8	7.5		10.2	8.6	7.4				9.8	8.3	150
155	6.8	6.5	6.1	4.9	9.8	8.4	7.2	5.2	9.9	8.4	7.2		9.7	8.3	7.1				9.5	8	155
160	6.3	6.1	5.8	4.7	9.4	8	6.9	5	9.5	8	6.9	5	9.3	8	6.8				9.1	7.7	160
165	5.9	5.8	5.4	4.4	8.9	7.7	6.6	4.8	9.1	7.7	6.7	4.8	9	7.6	6.5	4.8			8.7	7.5	165
170	5.5	5.5	5.1	4.2	8.5	7.4	6.3	4.7	8.7	7.4	6.4	4.7	8.7	7.3	6.3	4.7			8.3	7.2	170
175	5.2	5.2	4.8	4	8	7	6.1	4.5	8.3	7.1	6.1	4.5	8.4	7	6	4.5	8		8	6.9	175
180	4.9	4.9	4.5	3.8	7.6	6.7	5.8	4.3	8	6.8	5.8	4.4	8	6.8	5.8	4.4			7.7	6.6	180
185	4.6	4.5	4.3	3.6	7.3	6.4	5.6	4.2	7.6	6.5	5.6	4.2	7.7	6.5	5.5	4.2			7.4	6.4	185
190	4.3	4.3	4	3.4	7	6.1	5.3	4	7.2	6.3	5.4	4.1	7.4	6.3	5.3	4.1			7.2	6.1	190
195		4	3.8	3.2	6.7	5.8	5.1	3.9	6.9	6	5.2	4	7.1	6	5.1	3.9			6.9	5.9	195
200		3.8			6.4	5.5	4.8	3.8	6.6	5.7	4.9	3.8	6.7	5.8	4.9	3.8			6.6	5.7	200
205		3.5			6.1	5.3	4.6	3.6	6.3	5.4	4.7	3.7	6.4	5.5	4.7	3.6			6.4	5.5	205
210					5.7	5	4.4	3.5	6	5.1	4.5	3.5	6.1	5.3	4.5	3.5			6.1	5.3	210
215					5.4	4.8	4.2	3.4	5.8	4.9	4.3	3.4	5.8	5	4.4	3.4			5.8	5.1	215
220					5.1	4.6	4	3.2	5.5	4.7	4.1	3.3	5.6	4.8	4.2	3.3			5.6	4.9	220
225					4.9	4.3	3.8	3.1	5.3	4.5	3.9	3.1	5.4	4.6	4	3.2			5.3	4.6	225
230					4.6	4.1	3.6	3	5	4.3	3.8	3	5.1	4.4	3.8	3.1			5.1	4.4	230
235					4.4	3.9	3.4	2.8	4.7	4.1	3.6	2.9	4.9	4.2	3.6	2.9			4.8	4.2	235
240					4.2	3.7	3.3	2.7	4.5	3.9	3.4	2.8	4.7	4.1	3.5	2.8			4.6	4	240
245					4	3.5	3.1	2.6	4.3	3.7	3.3	2.6	4.5	3.9	3.4	2.7			4.4	3.9	245
250					3.8	3.4	3	2.5	4.1	3.5	3.1	2.6	4.3	3.7	3.2	2.6			4.1	3.7	250
255					3.6	3.2	2.9	2.5	3.9	3.4	3	2.5	4	3.5	3.1	2.5			3.9	3.6	255
260					3.4	3	2.7	2.5	3.7	3.2	2.9	2.4	3.9	3.4	3	2.4			3.7	3.4	260
265					3.2	2.9	2.6	2.5	3.5	3.1	2.8	2.4	3.7	3.2	2.8	2.4			3.5	3.3	265
270					3	2.7	2.5	2.5	3.4	3	2.6	2.4	3.5	3	2.7	2.3			3.2	3.1	270
275					2.9	2.6	2.4	2.5	3.2	2.8	2.5	2.4	3.4	2.9	2.6	2.3			3	3	275
280					2.7	2.5	2.4		3	2.7	2.4	2.4	3.2	2.8	2.5	2.3			2.8	2.8	280
285					2.6	2.4	2.4		2.8	2.5	2.3	2.4	3.1	2.7	2.4	2.3			2.4	2.7	285
290					2.4	2.3	2.4		2.7	2.4	2.3	2.4	2.9	2.6	2.3	2.3			2	2.4	290
295					2.4	2.3			2.6	2.4	2.3		2.8	2.5	2.2	2.3			1.6	2	295
300									2.5	2.3	2.3		2.6	2.3	2.1	2.3				1.6	300
305									2.3	2.2	2.2		2.5	2.3	2.1	2.3					305
310									2.2	2.2			2.4	2.2	2.1						310
315													2.3	2.2	2.1						315
320													2.2	2.1	2.1						320
325														2.1							325

* adapter - piece d'adaptateur

Lifting capacities

Forces de levage

TF 172

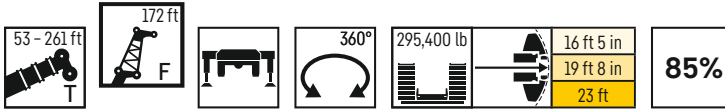

	191 ft + 7 ft 7 in*				209 ft + 7 ft 7 in*				226 ft + 7 ft 7 in*			243 ft + 7 ft 7 in*			259 ft + 7 ft 7 in*	261 ft + 7 ft 7 in*	
	0°	10°	20°	40°	0°	10°	20°	40°	0°	10°	20°	0°	10°	20°	0°	0°	
70	16.1																70
75	15.6				13.5												75
80	15.1				13.1				9								80
85	14.6				12.7				10.9			4					85
90	14.1				12.3				10.6			7.5					90
95	13.6				11.9				10.2			7.2			2.1	2.7	95
100	13.1				11.5				9.9			7			2	2.6	100
105	12.7	10.8			11.2				9.6			6.7			1.9	2.5	105
110	12.3	10.4			10.8	9.3			9.3			6.5			1.7	2.4	110
115	11.9	10.1			10.5	9			9			6.2				2.3	115
120	11.4	9.7			10.2	8.8			8.7	7.7		6				2.1	120
125	11	9.4			9.9	8.5			8.3	7.5		5.7				2	125
130	10.6	9			9.6	8.2			8	7.3		5.5	4.8			1.9	130
135	10.3	8.7	7.5		9.3	7.9			7.7	7.1		5.2	4.7			1.8	135
140	9.9	8.4	7.2		9	7.7			7.4	6.9		5	4.5			1.6	140
145	9.6	8.2	6.9		8.6	7.4	6.4		7.1	6.6		4.7	4.3				145
150	9.2	7.9	6.7		8.3	7.2	6.2		6.8	6.4	5.5		4.1				150
155	8.9	7.6	6.5		7.9	6.9	6		6.4	6.2	5.4		3.9				155
160	8.6	7.3	6.2		7.4	6.7	5.7		6.1	6	5.2		3.7	2.9			160
165	8.3	7	6		7	6.5	5.6		5.7	5.7	5.1		3.4	2.7			165
170	8	6.8	5.8		6.6	6.2	5.4		5.3	5.5	4.9		3.2	2.5			170
175	7.7	6.6	5.6		6.1	6	5.2		4.9	5.3	4.7		2.9	2.4			175
180	7.3	6.3	5.4	4.1	5.7	5.7	5		4.4	5	4.6		2.7	2.2			180
185	7	6.1	5.2	3.9	5.3	5.5	4.8	3.7	3.9	4.8	4.5		2.4	2.1			185
190	6.6	5.9	5	3.8	5	5.2	4.7	3.6	3.5	4.5	4.3			1.9			190
195	6.3	5.6	4.8	3.7	4.7	4.9	4.5	3.5		4.2	4.2			1.8			195
200	6	5.4	4.6	3.5	4.4	4.5	4.4	3.3		3.8	4			1.7			200
205	5.7	5.1	4.5	3.4	4	4.2	4.2	3.2		3.4	3.8			1.6			205
210	5.3	4.9	4.3	3.3	3.7	3.9	4.1	3.1		2.9	3.6						210
215	5	4.7	4.1	3.2	3.4	3.7	3.9	3		2.3	3.4						215
220	4.7	4.4	3.9	3.1	3.1	3.4	3.5	2.9			3						220
225	4.4	4.2	3.8	3	2.6	3.1	3.3	2.8			2.6						225
230	4.1	4	3.6	2.9	2.2	2.7	3.1	2.7									230
235	3.8	3.8	3.5	2.8	1.8	2.4	2.8	2.6									235
240	3.5	3.6	3.4	2.7		2	2.5	2.5									240
245	3.2	3.4	3.3	2.6		1.7	2.2	2.4									245
250	2.8	3.2	3.1	2.5			1.8	2.2									250
255	2.4	3	3	2.3			1.6	2.1									255
260	2	2.8	2.8	2.2				1.9									260
265		2.3	2.5	2.2				1.6									265
270		1.9	2.2	2.2													270
275			1.8	2.1													275
280				2.1													280
285				2													285
290				1.6													290

* adapter - piece d'adaptateur

Lifting capacities

Forces de levage

TF 184

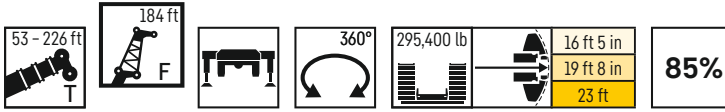

	53 ft + 7 ft 7 in*				105 ft + 7 ft 7 in*				122 ft + 7 ft 7 in*				139 ft + 7 ft 7 in*				157 ft + 7 ft 7 in*				
	0°	10°	20°	40°	0°	10°	20°	40°	0°	10°	20°	40°	0°	10°	20°	40°	0°	10°	20°	40°	
38	30.3																				38
40	29.5																				40
45	27.5				26.5																45
50	25.5				25.2				24												50
55	23.7				23.8				22.9				21.5								55
60	22.2				22.5				21.8				20.5				19				60
65	20.8				21.2				20.6				19.6				18.2				65
70	19.3				20.2				19.6				18.7				17.5				70
75	17.9	17			19.2				18.7				17.7				16.7				75
80	16.8	15.9			18.2	15.3			17.8				17				16				80
85	15.7	14.9			17.2	14.6			17	14.2			16.3				15.3				85
90	14.7	13.9			16.2	13.9			16.1	13.5			15.6	13			14.7				90
95	13.7	13			15.3	13.1			15.2	12.9			14.9	12.4			14.1	11.7			95
100	12.7	12			14.6	12.4			14.4	12.2			14.1	11.8			13.5	11.3			100
105	11.8	11.1	10.1		13.9	11.9			13.8	11.6			13.4	11.3			13	10.8			105
110	11	10.4	9.5		13.2	11.3			13.2	11.1			12.8	10.8			12.4	10.3			110
115	10.4	9.8	8.9		12.5	10.7	9.2		12.6	10.6	9		12.3	10.3			11.8	9.9			115
120	9.8	9.2	8.4		11.8	10.1	8.7		12	10.1	8.6		11.8	9.9	8.3		11.3	9.5			120
125	9.2	8.6	7.9		11.2	9.6	8.3		11.4	9.6	8.2		11.3	9.4	8		10.8	9.1	7.6		125
130	8.6	8.1	7.4		10.5	9.1	7.9		10.8	9.1	7.8		10.8	9	7.6		10.4	8.7	7.3		130
135	7.9	7.5	6.9		10	8.7	7.5		10.2	8.7	7.4		10.3	8.5	7.3		10	8.3	7		135
140	7.3	7.1	6.5		9.6	8.2	7.1		9.7	8.3	7.1		9.7	8.2	6.9		9.6	7.9	6.6		140
145	6.8	6.7	6.1		9.1	7.8	6.7		9.3	7.9	6.7		9.2	7.8	6.6		9.1	7.6	6.3		145
150	6.4	6.3	5.7		8.7	7.3	6.4		8.9	7.5	6.4		8.8	7.5	6.3		8.7	7.2	6.1		150
155	6	5.9	5.4	4.1	8.2	7	6		8.5	7.1	6.1		8.5	7.1	6		8.3	6.9	5.8		155
160	5.6	5.5	5	3.8	7.8	6.6	5.7	4.1	8.1	6.7	5.8		8.1	6.8	5.7		7.9	6.6	5.5		160
165	5.2	5.1	4.7	3.5	7.3	6.3	5.4	3.9	7.7	6.4	5.5	3.9	7.8	6.4	5.4		7.5	6.3	5.3		165
170	4.9	4.7	4.4	3.3	6.8	6	5.1	3.7	7.3	6.1	5.2	3.7	7.4	6.1	5.2	3.7	7.2	6	5		170
175		4.4	4.1	3	6.4	5.6	4.8	3.5	6.9	5.8	4.9	3.5	7	5.8	4.9	3.4	6.9	5.7	4.8	3.3	175
180		4.1	3.8	2.7	6.1	5.3	4.6	3.3	6.4	5.5	4.6	3.3	6.7	5.5	4.6	3.2	6.7	5.4	4.6	3.1	180
185		3.8	3.3	2.5	5.8	5	4.3	3	6.1	5.2	4.4	3	6.3	5.3	4.4	3	6.4	5.2	4.3	2.8	185
190		3.5	3		5.4	4.7	4.1	2.8	5.7	4.9	4.2	2.8	6	5	4.2	2.7	6.1	5	4.1	2.7	190
195		3.1	2.7		5.1	4.4	3.8	2.5	5.4	4.6	3.9	2.6	5.6	4.8	4	2.5	5.8	4.8	3.9	2.5	195
200		2.7			4.8	4.1	3.5	2.3	5.2	4.4	3.7	2.3	5.3	4.5	3.8	2.3	5.5	4.5	3.7	2.3	200
205					4.5	3.9	3.2	2.1	4.9	4.1	3.5	2.1	5	4.3	3.6	2.1	5.2	4.3	3.5	2.1	205
210					4.2	3.7	3	1.9	4.6	3.9	3.2	2	4.8	4	3.4	2	4.9	4.1	3.3	1.9	210
215					3.9	3.4	2.7	1.7	4.3	3.7	2.9	1.8	4.6	3.8	3.1	1.8	4.6	3.9	3.1	1.8	215
220					3.6	3.1	2.5	1.6	4.1	3.4	2.7	1.6	4.3	3.6	2.9	1.7	4.4	3.7	2.9	1.6	220
225					3.4	2.8	2.2		3.8	3.2	2.4		4.1	3.4	2.6		4.1	3.4	2.7		225
230					3.2	2.5	1.9		3.5	3	2.2		3.9	3.2	2.4		4	3.2	2.5		230
235					3	2.3	1.7		3.3	2.7	2		3.6	3	2.2		3.8	3	2.2		235
240					2.7	2	1.5		3.1	2.4	1.8		3.4	2.8	2		3.6	2.8	2		240
245					2.4	1.8			2.9	2.1	1.6		3.1	2.5	1.8		3.4	2.6	1.8		245
250					2.2	1.6			2.7	1.9			2.9	2.3	1.6		3.2	2.4	1.7		250
255					1.9				2.4	1.8			2.7	2			3	2.2	1.5		255
260					1.6				2.2	1.6			2.5	1.8			2.7	2			260
265									1.9				2.3	1.6			2.5	1.8			265
270									1.7				2.1				2.3	1.6			270
275													1.9				2.1				275
280													1.7				1.9				280
285																	1.7				285
290																	1.5				290

* adapter - piece d'adaptateur

Lifting capacities

Forces de levage

TF 184

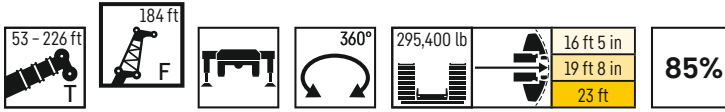

	174 ft + 7 ft 7 in*				191 ft + 7 ft 7 in*			209 ft + 7 ft 7 in*			226 ft + 7 ft 7 in*			
	0°	10°	20°	40°	0°	10°	20°	0°	10°	20°	0°	10°	20°	
65	16.5													65
70	15.9				14									70
75	15.3				13.6									75
80	14.7				13.1			11.3						80
85	14.1				12.7			10.9			9.1			85
90	13.6				12.2			10.6			8.9			90
95	13.1				11.7			10.2			8.6			95
100	12.6	10.4			11.3			9.9			8.4			100
105	12.1	10.1			10.9			9.5			8.1			105
110	11.6	9.7			10.6	8.8		9.2			7.8			110
115	11.2	9.3			10.2	8.5		8.9			7.6			115
120	10.7	8.9			9.8	8.2		8.6	7.2		7.3			120
125	10.2	8.6			9.4	7.9		8.3	7		7	6.1		125
130	9.8	8.2			9.1	7.6		8	6.7		6.7	5.9		130
135	9.4	7.9	6.6		8.7	7.3		7.7	6.5		6.4	5.7		135
140	9.1	7.6	6.3		8.4	7	5.8	7.4	6.2		6.1	5.5		140
145	8.7	7.2	6		8	6.7	5.6	7.2	6		5.8	5.3		145
150	8.4	6.9	5.8		7.7	6.5	5.4	6.9	5.8	4.8	5.6	5.1		150
155	8	6.6	5.5		7.5	6.2	5.1	6.5	5.6	4.6	5.3	4.9		155
160	7.7	6.3	5.3		7.2	5.9	4.9	6.2	5.3	4.4	5	4.7	3.9	160
165	7.3	6.1	5.1		6.9	5.7	4.7	5.8	5.1	4.3	4.6	4.5	3.7	165
170	7	5.8	4.8		6.4	5.4	4.5	5.4	4.9	4.1	4.3	4.3	3.5	170
175	6.6	5.6	4.6		6.1	5.2	4.3	5	4.7	3.9	3.8	4.1	3.3	175
180	6.3	5.3	4.4	2.8	5.8	5	4.1	4.7	4.5	3.7	3.3	3.8	3.1	180
185	6	5.1	4.2	2.6	5.6	4.8	3.9	4.3	4.3	3.6	2.8	3.6	2.9	185
190	5.8	4.8	4	2.5	5.3	4.6	3.8		4	3.4	2.3	3.3	2.8	190
195	5.6	4.6	3.8	2.3	5	4.4	3.6		3.8	3.2	1.8	3	2.6	195
200	5.3	4.4	3.6	2.1	4.8	4	3.4		3.6	3		2.7	2.5	200
205	5.1	4.2	3.4	2	4.5	3.8	3.2		3.3	2.8		2.2	2.3	205
210	4.8	4	3.2	1.8	4.2	3.7	3		3	2.6		1.8	2.1	210
215	4.6	3.8	3	1.7	4	3.5	2.8			2.4			1.9	215
220	4.4	3.6	2.8	1.6	3.7	3.3	2.5			2.3			1.7	220
225	4.1	3.4	2.6		3.4	3	2.3			2.1				225
230	3.9	3.3	2.4		3.1	2.8	2.1							230
235	3.6	3	2.3		2.8	2.6	1.9							235
240	3.4	2.8	2.1			2.3	1.8							240
245	3.2	2.5	1.8			2.1	1.6							245
250	3	2.3	1.6											250
255	2.8	2.1												255
260	2.5	2												260
265	2.3	1.8												265
270	2	1.6												270
275	1.7													275

* adapter - piece d'adaptateur

Lifting heights

Hauteurs de levage

TN

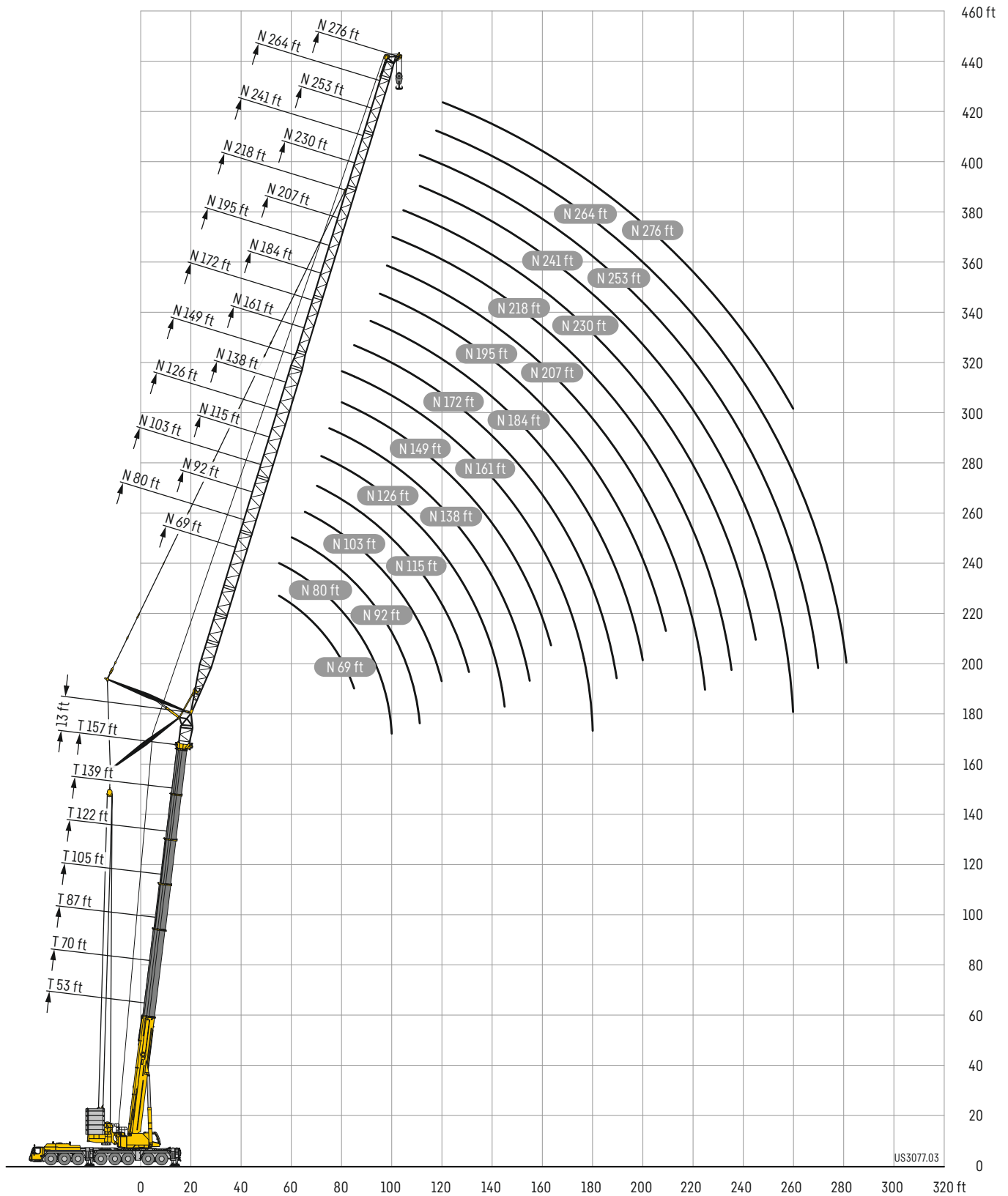

Lifting capacities

Forces de levage

TN 46 - 57

	53 ft + 13 ft*			70 ft + 13 ft*			87 ft + 13 ft*			
	83°	75°	67°	83°	75°	67°	83°	75°	67°	
26	261.6									26
28	261.6			260.2						28
30	261.6			257.6						30
32	261.6			251.7			247.3			32
34	259.4			245.8			243.5			34
36	255.7			239.8			238			36
38	250.1			233.6			232.7			38
40	243.6	258.2		227.1			227.2			40
45	220.9	232.1		210.1	207.3		212.5			45
50	192	210.2		189.1	205		196			50
55		191.4	184.3	155.9	186.9		173.9	180.7		55
60		174.7	168.6		171.6			165.2		60
65			154.9		156.6	150.2		151.8		65
70						138.5		139.7	129.9	70
75						128.2			120.4	75
80									112	80

* adapter - piece d'adaptateur

	53 ft + 13 ft*			70 ft + 13 ft*			87 ft + 13 ft*			105 ft + 13 ft*			122 ft + 13 ft*			
	83°	75°	67°	83°	75°	67°	83°	75°	67°	83°	75°	67°	83°	75°	67°	
30	261.6															30
32	261.5			245.1												32
34	259.9			240.6												34
36	257.4			235.1			227.2									36
38	251			229.6			224.5			191.2						38
40	244.4			224.2			221.1			191.8						40
45	227.7			210.7			209.1			187.7				158		45
50	210	209.2		196.6			196.9			186.8				159.6		50
55	190.8	190.6		181.5	185.5		183.9			184.4				158.9		55
60	167.8	174.3		164.1	171		169.4	166		173.3				156.2		60
65		160.3	154.1	141.2	157.3		151.5	152.6		159.5	146.9			151.5		65
70		148.1	142.2		145.4	137.8		140.8		140.4	135.5			140.7	129.1	70
75			131.8		134.6	127.7		130.5			126.7				120.3	75
80			122.5			119		121.4	113.1		118.6				112.1	80
85						111.1					110.8	102			104.8	85
90									105.7			95.7			98.2	90
95									99.2							95
100									94.3			90			82.3	100
105												84.9			77.6	105
															73.4	105

* adapter - piece d'adaptateur

Lifting capacities

Forces de levage

TN 69

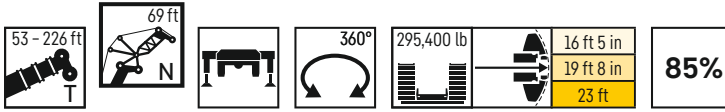

	53 ft + 13 ft*			70 ft + 13 ft*			87 ft + 13 ft*			105 ft + 13 ft*			122 ft + 13 ft*			139 ft + 13 ft*			
	83°	75°	67°	83°	75°	67°	83°	75°	67°	83°	75°	67°	83°	75°	67°	83°	75°	67°	
34	233.7																		34
36	235			213.5															36
38	236.1			213.4			189												38
40	235.8			212.7			189.9												40
45	226.1			205.2			192			163.4			134.8						45
50	213.3			194.6			189.3			164.4			135.6			109			50
55	197.6	189.7		184			181.7			161.9			135.8			109.1			55
60	180.8	173.5		172.6	168.7		172			161.4			135.8			109.4			60
65	166.3	159.6		160.5	156		161.5	151.8		158.3			135.8			109.4			65
70	150.4	147.7	141.4	146.8	144.6		149.7	140.1		147.2	134.7		135.4			109.4			70
75	121.8	137	131.1	130.4	134	126.6	136.5	129.9		136.6	124.9		133.1	121.3		109.4			75
80		127.6	122.1		124.8	118		121		126.3	117.5		125.1	113.4		109.4	99.5		80
85		119	114.2		116.6	110.3		113.1	104.9	110.3		106.1		106.1		109.2	96		85
90			107.1			103.5		106.1	98.5	103.5		99.5		99.5			92.3		90
95						97.4			92.6	97.3	89.3		93.6				88.8		95
100									88.3		84.3		88.3	79.1			84.3		100
105									83.7		79.7			74.8			79.6		105
110											75.5			71				65.8	110
115														67.4				62.5	115
120														64				59.4	120
125																		56.5	125

* adapter - piece d'adaptateur







	157 ft + 13 ft*			174 ft + 13 ft*			191 ft + 13 ft*			209 ft + 13 ft*			226 ft + 13 ft*			
	83°	75°	67°	83°	75°	67°	83°	75°	67°	83°	75°	67°	83°	75°	67°	
55	82.8			63.4												55
60	81.5			62.6			47.3									60
65	80.2			61.8			46.7			34.3						65
70	78.3			61			46.1			33.9			24.3			70
75	76.3			60.1			45.6			33.5			24			75
80	74.3			59.1			45			33.1			23.8			80
85	72.5			58.2			44.4			32.7			23.5			85
90		62.4		57.1			43.9			32.3			23.2			90
95		59.9			46.2					32			22.9			95
100		57.6			44.5											100
105		55.4			42.7			33.1								105
110		53.6			41.2			31.7				24.5				110
115					39.8			30.4				23.6				115
120			44.2					29.2				22.6		16.9		120
125			42.2									21.7		16.1		125
130			40.6													130
135								28.9								135
140								27.7								140
145										20						145
150										19.1						150
155													12.5			155
160																160

* adapter - piece d'adaptateur

Lifting capacities

Forces de levage

TN 80

	53 ft + 13 ft*			70 ft + 13 ft*			87 ft + 13 ft*			105 ft + 13 ft*			122 ft + 13 ft*			139 ft + 13 ft*				
	80 ft																			
	83°	75°	67°	83°	75°	67°	83°	75°	67°	83°	75°	67°	83°	75°	67°	83°	75°	67°		
36	216.8																		36	
38	217																		38	
40	216.7			199.6															40	
45	213.5			199.1			178.3				151.9								45	
50	209.4			192.6			179.8				153.1			126.5					50	
55	197.1			182.5			177				153.2			126.9			100.9		55	
60	180.4	173		172.5			170.3				150.9			127.2			101.4		60	
65	166	159.2		162.4	155.2		161.2				149.2			127.3			101.4		65	
70	153.6	147.3		151.8	144.4		149.7	139.6			146.4			126.7			101.1		70	
75	142.8	136.7	130.6	141	133.8		139.1	129.4			136.4	124.7		125.3			100.8		75	
80	126.2	127.3	121.7	129.1	124.7		129.6	120.6			127	116.2		122.7	111.4		100.5		80	
85	103.3	119	113.8	115.3	116.6	110.1	120.2	112.7			118.7	109.3		117.1	105.6		100.2	91.6	85	
90		111.7	106.8		109.5	103.3	105.7	105.8	97.9		111.2	103.5		109.9	99.1	105.8	99.3	88.7	90	
95		105	100.5		103	97.3		99.6	92.2			97.4		99.8	93.3		98.2	85.7	95	
100			94.9		96.2	91.8		94.8	87.2			91.9	84.1		88.1			82.9	100	
105						86.8			83.5			86.9	79.5		83.3			79.3	105	
110						82.3			79.3				75.4		79	70.5		75.2	110	
115									75.3				71.7			66.9		71.4	61.9	115
120																			58.9	120
125																			56.1	125
130																			53.6	130
135																			51	135

* adapter - piece d'adaptateur

	157 ft + 13 ft*			174 ft + 13 ft*			191 ft + 13 ft*			209 ft + 13 ft*			226 ft + 13 ft*							
	80 ft																			
	83°	75°	67°	83°	75°	67°	83°	75°	67°	83°	75°	67°	83°	75°	67°					
55	75.5																			55
60	74.6			57.3																60
65	73.6			56.5			42.4													65
70	72.5			55.8			42				30.5			21.4						70
75	71.2			55.1			41.4				30.1			21.1						75
80	69.7			54.3			40.9				29.8			20.9						80
85	68.1			53.6			40.5				29.4			20.6						85
90	66.5			52.8			40				29			20.4						90
95	65.1	57.4		52			39.5				28.7			20.2						95
100	63.7	55.4		51.2	42.3		39.1				28.4			20						100
105		53.4			40.8						28.1			19.7						105
110		51.6			39.4					30.4										110
115		49.9			38.1					29.2			21.3							115
120		48.4			36.8					28.1			21.4							120
125			41.3		35.6					27			20.5					15		125
130			39.6							26			19.7					14.3		130
135			38.1				28						18.9					13.7		135
140			36.7				26.8											13.1		140
145			35.4				25.7				18.2									145
150							24.7				17.4									150
155											16.6				9.3					155
160															10.6					160
165															10.2					165
170																			4.9	170

* adapter - piece d'adaptateur

Lifting capacities

Forces de levage

TN 92

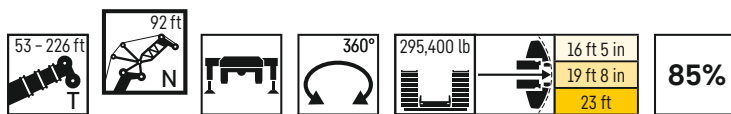

	53 ft + 13 ft*			70 ft + 13 ft*			87 ft + 13 ft*			105 ft + 13 ft*			122 ft + 13 ft*			139 ft + 13 ft*			
	83°	75°	67°	83°	75°	67°	83°	75°	67°	83°	75°	67°	83°	75°	67°	83°	75°	67°	
40	190.1																		40
45	191.2			176.2			156.1												45
50	189			178.2			157.7			134.7									50
55	185.4			176			158.5			135.1			111.9			89.6			55
60	178.5			169.4			159.1			135.4			112.1			89.7			60
65	165.3	158.3		161.3			156.8			135.7			112.4			89.8			65
70	153	146.5		151.2	142.3		148.5			132.5			112.7			90			70
75	142.2	135.9		140.5	133.1		138.5	128.6		133			113			90.2			75
80	132.7	126.7		131.1	124		129.1	119.8		126.6	115.4		113.1			90.3			80
85	124	118.4	113	122.5	116		120.7	112.1		118.3	107.9		111.7	102.3		90.4			85
90	110.8	111.2	106.1	115	108.9	102.6	113.3	105.2		111	101.4		108.7	98.3		90.3	62.2		90
95	93.8	104.6	99.8	105.5	102.5	96.5	106.6	99		104.5	96.5		102.8	92.7		90.1	82		95
100		98.8	94.3	94.3	96.8	91.2	97.9	93.4	86.7	98.6	91.1		98.2	87.5		89.2	79.7		100
105		93.3	89.2		91.5	86.2		89	82.5		86.1	78.5	91.6	82.8		88.3	77.2		105
110			84.6		86.1	81.8		84.6	78.6		81.7	74.4		78.5			74.3		110
115						77.7		80.3	74.7		77.6	70.7		74.5	66.2		70.5		115
120						73.9			71.1		73.7	67.3		70.9	63		67.1		120
125									67.7			64.1		67.5	60		63.9	55	125
130												61			57.2		60.8	52.5	130
135												58.2			54.6			50.1	135
140															52.1			47.8	140
145																		45.7	145
150																		43.6	150

* adapter - piece d'adaptateur

	157 ft + 13 ft*			174 ft + 13 ft*			191 ft + 13 ft*			209 ft + 13 ft*			226 ft + 13 ft*			
	83°	75°	67°	83°	75°	67°	83°	75°	67°	83°	75°	67°	83°	75°	67°	
60	68															60
65	67.1			51.3												65
70	66.3			50.7			37.9			27.3						70
75	65.5			50.1			37.5			27.1			18.3			75
80	64.5			49.5			37.1			26.8			18			80
85	63.3			48.9			36.7			26.5			17.8			85
90	62.1			48.3			36.3			26.2			17.5			90
95	60.8			47.7			35.9			25.9			17.3			95
100	59.5	52.7		47			35.5			25.6			17.1			100
105	58.3	51		46.4	38.7		35.1			25.4			16.9			105
110	56.8	49.3		45.8	37.4		34.8			25.1			16.8			110
115		47.7			36.2		34.4	28.1		24.9			16.7			115
120		46.2			35.1			27.1			19		16.7			120
125		44.8			33.9			26.1			19.6					125
130		43.6	31.8		32.9			25.1			18.9			13.5		130
135			36.9		31.9			24.2			18.2			13		135
140			35.5			22		23.3			17.5			12.5		140
145			34.2			24.9					16.8			12		145
150			33			23.9								11.5		150
155			31.9			23				16						155
160						22.1				15.3						160
165										14.6			9.8			165
170										13.9			9.4			170
175													9			175
180															4.5	180
															4.1	180

* adapter - piece d'adaptateur

Lifting capacities

Forces de levage

TN 103

	53 ft + 13 ft*			70 ft + 13 ft*			87 ft + 13 ft*			105 ft + 13 ft*			122 ft + 13 ft*			139 ft + 13 ft*			
	83°	75°	67°	83°	75°	67°	83°	75°	67°	83°	75°	67°	83°	75°	67°	83°	75°	67°	
45	171.1																		45
50	170.3			159.4			141.8												50
55	167.5			159.6			142.2			122			101.8						55
60	164.3			158.4			142.4			122.2			101.9			81			60
65	159.9			156.3			142.7			122.5			102			81.3			65
70	151.8	145.1		149			142.1			122.8			102.2			81.6			70
75	141.8	135.5		139.4	130.9		136.1			121.4			102.5			81.9			75
80	132.4	126.3		130.7	123		127.8	118.5		120.2			102.5			82.1			80
85	123.8	118.1		122.3	115.4		120.1	111.3		117.2	106.9		102.4			82			85
90	116.2	110.8	105.7	114.8	108.3		112.8	104.5		110.6	100.6		101.9	95		81.8			90
95	109.3	104.3	99.4	108	101.9	95.8	106.2	98.3		104.2	94.7		100.4	91.1		81.7	57.7		95
100	98.5	98.5	93.9	101.9	96.2	90.5	100.2	92.9		98.3	90.6		96.9	86.9		81.6	75.9		100
105	85.4	93.2	88.9	95.5	91.1	85.6	94.7	87.8	82.2	92.9	85.9		92.4	82.2		81.4	74.2		105
110		88.4	84.3	82.2	86.4	81.2	89.3	83.3	78	88	81.5		87.7	77.9		80.7	72.3		110
115		83.9	80.1		82	77.2		80	74.1	83.3	77.5	70.3	83.1	74		79.9	70.2		115
120			76.2		78	73.5		76.1	70.6		73.7	67		70.5	62.3	77.5	67		120
125			72.5			69.9		72.4	67.2		70.1	63.8		67.1	59.4		63.8		125
130						66.6			64		66.8	60.8		63.9	56.6		60.8	52.2	130
135									61.1			58		61	54		58	49.9	135
140									58.3			55.4			51.6		55.4	47.6	140
145												53			49.3			45.5	145
150															47.2			43.5	150
155																		41.6	155
160																		39.8	160

* adapter - piece d'adaptateur

	157 ft + 13 ft*			174 ft + 13 ft*			191 ft + 13 ft*			209 ft + 13 ft*			226 ft + 13 ft*						
	83°	75°	67°	83°	75°	67°	83°	75°	67°	83°	75°	67°	83°	75°	67°				
65	61.6			44.5															65
70	60.9			46.5				34.4											70
75	60.2			46				34.1				23.8							75
80	59.5			45.5				33.8				23.6			15.2				80
85	58.7			44.9				33.4				23.4			15				85
90	57.8			44.4				33.1				23.2			14.7				90
95	57			43.9				32.7				23			14.5				95
100	55.9			43.4				32.4				22.7			14.3				100
105	54.7	48.5		42.9				32				22.5			14.1				105
110	53.6	47.1		42.4	35.8			31.7				22.2			13.9				110
115	52.6	45.7		41.8	34.6			31.4				22			13.8				115
120	51.3	44.3		41.3	33.4			31.1	25.8			21.8			13.7				120
125		43		40.9	32.3			30.9	24.9			21.6	16.9		13.6				125
130		41.7			31.4				23.9				17.7		13.5				130
135		40.5			30.4				23				17.1			11.9			135
140		39.5	34.5		29.5				22.2				16.5			11.5			140
145		38.6	33.2		28.7				21.4				15.9			11.2			145
150			32		27.9	23			20.7				15.3			10.8			150
155			30.9			22.1			20				14.7			10.5			155
160			29.8			21.2										10.1			160
165			28.9			20.4													165
170						19.6								8.9					170
175						18.9								8.5					175
180														8.2					180
185														7.9				3.7	185
190																		3.4	190

* adapter - piece d'adaptateur

Lifting capacities

Forces de levage

TN 115

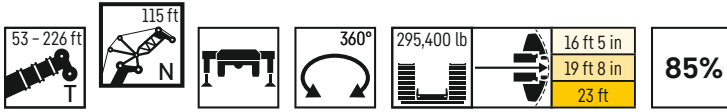

	53 ft + 13 ft*			70 ft + 13 ft*			87 ft + 13 ft*			105 ft + 13 ft*			122 ft + 13 ft*			139 ft + 13 ft*			
	83°	75°	67°	83°	75°	67°	83°	75°	67°	83°	75°	67°	83°	75°	67°	83°	75°	67°	
50	152.8			142.8															50
55	150.6			142.8			127.8												55
60	148.1			141.7			127.9			110.1			92.3						60
65	145.8			140.2			128			110.2			92.4			72.8			65
70	143			138.6			127.3			110.3			92.5			73			70
75	138.5	133		136			126.6			110.6			92.6			73.2			75
80	130.9	124.7		128.1	120.5		124.4			110.3			92.8			73.3			80
85	123.1	117.3		120.5	113.3		118.1	109.3		108.7			92.7			73.3			85
90	115.7	110.2		113.8	107.5		111.6	103.2		107.2	98.5		92.3			73.2			90
95	108.8	103.7	98.8	107.2	101.3		105.6	97.6		103.4	93.2		91.9	86.7		73.1			95
100	101.9	97.9	93.2	101.2	95.7		99.7	92.3		98.1	88.4		91.1	84		73	52.2		100
105	93.6	92.6	88.2	95.6	90.5	84.9	94.3	87.2		92.9	83.8		90.1	80.9		73	69		105
110	83.5	87.8	83.6	90.6	85.8	80.5	89.4	82.7	76	87.7	80.6		86.2	77.1		72.9	67.7		110
115	72.8	83.3	79.5	81.5	81.5	76.5	84.8	78.6	72.6	83.2	76.6		82.3	73.2		72.8	66.3		115
120	60	79.3	75.6	70.1	77.5	72.8	78.8	75	69.5	79.1	72.9	65.9	78.5	69.6		72.6	64.7		120
125		75.3	71.9		73.8	69.3		71.6	66.3	75	69.4	62.8	73.9	66.3		72.1	62.9		125
130			68.6		70.3	66.1		68.3	63.1		66.1	59.9	66	63.2	55.6	69.6	60		130
135			65.4			63		65.1	60.2		63.1	57.1		60.2	53		57.2	48.8	135
140						60.2			57.5		60.2	54.5		57.5	50.6		54.6	46.6	140
145									55			52.1		55	48.4		52.2	44.5	145
150									52.6			49.9			46.3		49.9	42.5	150
155												47.8			44.3			40.7	155
160															42.4			38.9	160
165															40.6			37.3	165
170																		35.7	170

* adapter - piece d'adaptateur

	157 ft + 13 ft*			174 ft + 13 ft*			191 ft + 13 ft*			209 ft + 13 ft*			226 ft + 13 ft*		
	83°	75°	67°	83°	75°	67°	83°	75°	67°	83°	75°	67°	83°	75°	
70	55.3			42.1											70
75	54.7			41.7			30.5								75
80	54.1			41.3			30.3				20.9			12.3	80
85	53.5			40.8			30				20.7			12.1	85
90	52.9			40.3			29.7				20.5			11.8	90
95	52.2			39.9			29.4				20.2			11.6	95
100	51.5			39.4			29				20			11.4	100
105	50.7			39			28.7				19.8			11.2	105
110	49.8	43.9		38.5			28.4				19.6			11	110
115	48.9	42.8		38.1	31.8		28.1				19.4			10.8	115
120	48.1	41.6		37.6	31.4		27.8				19.2			10.6	120
125	47.2	40.5		37.2	30.3		27.5	23			19			10.4	125
130	45.2	39.4		36.8	29.3		27.3	22.2			18.8			10.3	130
135		38.3		36.6	28.4		27.1	21.4			18.6	15.4		10.2	135
140		37.3			27.6			20.6			18.4	14.9		10.1	140
145		36.4	31.7		26.8			19.9				14.3		8.8	145
150		35.5	30.5		26			19.2				13.8		8.6	150
155		34.8	29.5		25.3	20.6		18.5				13.3		8.4	155
160			28.5		24.7	19.8		17.9				12.8		8.3	160
165			27.5			19		17.3		10.5		12.4		8.2	165
170			26.6			18.2					11.9			8.1	170
175			25.9			17.5					11.3			8	175
180						16.9					10.8		7.2		180
185						16.3					10.4		6.9		185
190										10.1			6.6		190
195													6.3		195
200													6		200

* adapter - piece d'adaptateur

Lifting capacities

Forces de levage

TN 126

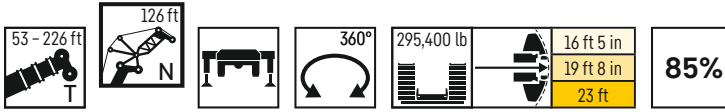

	53 ft + 13 ft*			70 ft + 13 ft*			87 ft + 13 ft*			105 ft + 13 ft*			122 ft + 13 ft*			139 ft + 13 ft*			
	83°	75°	67°	83°	75°	67°	83°	75°	67°	83°	75°	67°	83°	75°	67°	83°	75°	67°	
55	135.1			128.1															55
60	133.1			127.1			115.6			101									60
65	131.1			125.8			114.8			100.9			83.2			65.6			65
70	129.3			124.4			114			100.4			83.5			65.8			70
75	127.3			123.1			113.2			99.9			83.8			65.9			75
80	124.3	121.8		121.7			112.4			99.4			83.9			66.1			80
85	120.8	115.2		118.6	111.6		111.7			99			83.9			66.1			85
90	114.2	108.7		112.2	105.3		109.5	101.2		98.6			83.7			66.1			90
95	108.1	102.9		106.2	99.7		103.7	95.8		98.2	91.9		83.5			66			95
100	102.3	97.4		100.9	94.8		98.5	90.9		96.6	87.2		83.2	79.5		65.9			100
105	96.7	92.1	87.6	95.6	90		93.7	86.5		92.1	82.9		82.8	78.2		65.8			105
110	90.1	87.3	83.1	90.6	85.4	80	89	82.3		87.9	79		82.2	74.5		65.8	63.1		110
115	83.3	82.9	79	86	81.1	76	84.5	78.1		83.5	75.6		81.5	72.7		65.8	62.4		115
120	75.1	78.9	75.1	81.9	77.1	72.3	80.4	74.4	68.9	79.5	72.5		77.5	69.5		65.8	61.4		120
125	66.3	75.2	71.5	74.4	73.4	68.9	76.6	70.7	66.1	75.1	69	62.3	74.5	66.3		65.8	60.2		125
130	57	71.7	68.2	65	70	65.6	71.7	68.1	63	71.6	65.7	59.4	71.4	63.2		65.8	58.9		130
135		68.4	65.1		66.8	62.6	62.1	65.1	60.1	68.2	62.7	56.6	67.8	60.2	52.9	65.6	56.8		135
140		61.4	62.2		63.9	59.9		62.2	57.4		59.9	54.1	62.1	57.6	50.5	63.3	54.2		140
145			59.5		59.7	57.3		59.5	54.9		57.3	51.7		55	48.3		51.8	43.9	145
150			57			54.8		57	52.6		54.9	49.5		52.7	46.2		49.6	42	150
155					52.6				50.4		52.5	47.4		50.4	44.2		47.5	40.2	155
160									48.3			45.4		48.3	42.4		45.5	38.5	160
165												43.6			40.6			36.9	165
170												41.8						35.3	170
175															37.4			33.9	175
180																		32.5	180

* adapter - piece d'adaptateur

	157 ft + 13 ft*			174 ft + 13 ft*			191 ft + 13 ft*			209 ft + 13 ft*			226 ft + 13 ft*		
	83°	75°	67°	83°	75°	67°	83°	75°	67°	83°	75°	67°	83°	75°	
70	50.6														70
75	50.2			38.1											75
80	49.7			37.8			27.1			16.9					80
85	49.2			37.5			26.9			18			9.9		85
90	48.7			37.1			26.7			17.8			9.7		90
95	48.1			36.7			26.4			17.5			9.5		95
100	47.6			36.2			26.2			17.3			9.2		100
105	47.1			35.9			25.9			17.1			9		105
110	46.5			35.5			25.6			16.9			8.8		110
115	45.8	40.3		35.1			25.3			16.7			8.6		115
120	45	39.4		34.7			25			16.5			8.4		120
125	44.3	38.5		34.3	29		24.8			16.4			8.2		125
130	43.6	37.6		34	28.1		24.6	20.8		16.3			8.1		130
135	42.9	36.6		33.6	27.1		24.3	20.3		16.2			7.9		135
140	41	35.6		33.3	26.2		24.1	19.6		16.2	13.8		7.8		140
145	39.6	34.7		33.1	25.4		24	18.9		16.2	13.4		7.7	6.7	145
150		33.8			24.7		23.8	18.3		16.2	12.9		7.6	6.5	150
155		33	28.5		24			17.7			12.4			6.3	155
160		32.3	27.4		23.4			17.1			12			6.2	160
165		31.7	26.6		22.7	18.2		16.5			11.5			6	165
170			25.7		22.2	17.4		15.9			11.1			5.9	170
175			24.8			16.8		15.4	10.8		10.8			5.7	175
180			24.1			16.1					10.5			5.6	180
185			23.4			15.5						6.3		5.5	185
190			22.9			15									190
195						14.5									195
200															200
205															205
210															210

* adapter - piece d'adaptateur

Lifting capacities

Forces de levage

TN 138

53 - 226 ft | 138 ft | 360° | 295,400 lb | 16 ft 5 in | 19 ft 8 in | 23 ft | 85%

	53 ft + 13 ft*			70 ft + 13 ft*			87 ft + 13 ft*			105 ft + 13 ft*			122 ft + 13 ft*			139 ft + 13 ft*			
	83°	75°	67°	83°	75°	67°	83°	75°	67°	83°	75°	67°	83°	75°	67°	83°	75°	67°	
55	121.9																		55
60	120.5			114.2			104.1												60
65	118.8			113.2			103.4			90.7									65
70	117.1			112.3			102.7			90.5			75.2			59.1			70
75	115.6			111.2			101.9			90			75.4			59.2			75
80	113.9			110.1			101.3			89.5			75.6			59.4			80
85	111.4	110.3		108.7			100.6			89.1			75.8			59.5			85
90	108.4	106.7		106.1	102.9		99.3			88.7			75.9			59.5			90
95	105.5	101		103.5	97.4		97.7	93.9		88.4			76			59.4			95
100	100.8	95.8		98.7	92.4		95.9	89.2		88	85		75.7			59.4			100
105	95.9	91.1		93.9	88		92	84.8		87.7	80.8		75.4	72.4		59.3			105
110	91.2	86.7	82.5	89.5	84.3		87.8	80.8		85.7	77		75.1	71.8		59.2			110
115	86.1	82.4	78.3	85.3	80.5	75.4	83.8	77.1		82	73.4		74.7	69.5		59.2	57.2		115
120	80.5	78.4	74.5	81.1	76.6	71.7	80	73.7		78.5	70.1		74.3	66.4		59.2	56.8		120
125	74.9	74.7	70.9	77.3	72.9	68.3	76.2	70.3	64.6	75	68.2		73.3	64.9		59.2	56.3		125
130	68	71.2	67.6	73.6	69.5	65.1	72.7	67	62	71.5	65.3		70.1	62.1		59.2	55.4		130
135	60.6	67.9	64.5	67	66.4	62.1	69.4	63.9	59.2	68.2	62.3	56.1	67.5	59.4		59.2	54.4		135
140	52.9	65	61.6	59.4	63.4	59.3	65.5	61.5	56.5	64.7	59.5	53.5	64.5	56.7	49.5	59.2	53.1		140
145		62.2	59		60.7	56.7	58.1	58.8	54	61.9	56.9	51.1	61.6	54.2	47.3	59.1	51		145
150		57.1	56.5		58.1	54.3		56.3	51.7	56.3	54.5	48.9	57.4	51.9	45.2	57.4	48.7	41	150
155			54.2		55.2	52.1		54	49.6		52.2	46.9		49.7	43.3	54.8	46.7	39.2	155
160			52			49.9		51.7	47.5		50	44.9		47.7	41.5		44.7	37.5	160
165						47.9					48	43.1		45.7	39.7		42.9	35.9	165
170									43.8			41.4		43.9	38.1		41.1	34.4	170
175									42.1			39.7			36.6		39.5	33	175
180												38.1			35.1			31.6	180
185															33.8			30.4	185
190																		29.1	190
195																		28	195

* adapter - piece d'adaptateur

	157 ft + 13 ft*			174 ft + 13 ft*			191 ft + 13 ft*			209 ft + 13 ft*			226 ft + 13 ft*		
	83°	75°	67°	83°	75°	67°	83°	75°	67°	83°	75°	67°	83°	75°	
75	45.7														75
80	45.3			34.1			22								80
85	44.9			33.9			24			15					85
90	44.5			33.6			23.8			14.8			7.2		90
95	44			33.3			23.6			14.5			7		95
100	43.5			32.9			23.4			14.3			6.8		100
105	43.1			32.5			23.2			14.1			6.5		105
110	42.6			32.2			22.9			13.8			6.3		110
115	42.2			31.9			22.7			13.7			6.1		115
120	41.6	36.6		31.5			22.4			13.5			5.9		120
125	41	35.8		31.2			22.2			13.3			5.8		125
130	40.4	35		30.9	26.2		22			13.2			5.6		130
135	39.8	34.2		30.5	25.4		21.8	18.5		13.1			5.4		135
140	39.2	33.4		30.2	24.6		21.6	18		12.9			5.3		140
145	38.6	32.6		29.9	23.8		21.4	17.4		12.8	11.4		5.1		145
150	36.9	31.7		29.6	23		21.2	16.8		12.8	11.2		5	4.1	150
155	35.9	30.9		29.4	22.2		21	16.2		12.8	11		4.9	3.9	155
160		30.2	26		21.6		20.9	15.7		12.8	10.7		4.8	3.8	160
165		29.5	25.2		21			15.1			10.4		4.7	3.6	165
170		28.9	24.3		20.4	16.2		14.6			10			3.4	170
175		28.3	23.5		19.9	15.5		14.1			9.7			3.2	175
180		28	22.7		19.4	14.9		13.6	9.4		9.4			3.1	180
185			22			14.3		13.2			9.1				185
190			21.3			13.8					8.8				190
195			20.7			13.2					8.4			4.9	195
200			20.1			12.7					8.1			4.6	200
205						12.2					7.8			4.3	205
210											7.4			4.1	210
215											7.1			3.8	215
220														3.6	220

* adapter - piece d'adaptateur

Lifting capacities

Forces de levage

TN 149

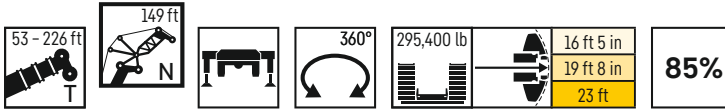

	53 ft + 13 ft*			70 ft + 13 ft*			87 ft + 13 ft*			105 ft + 13 ft*			122 ft + 13 ft*			139 ft + 13 ft*			
	83°	75°	67°	83°	75°	67°	83°	75°	67°	83°	75°	67°	83°	75°	67°	83°	75°	67°	
60	109.2																		60
65	107.9			102.5			93.6												65
70	106.5			101.6			93			82			68.1						70
75	105.2			100.8			92.4			81.7			68.2			53.7			75
80	103.9			99.9			91.8			81.2			68.4			53.8			80
85	102.6			99.1			91.1			80.8			68.6			53.9			85
90	101.1	99.3		98.2			90.5			80.4			68.7			54			90
95	99.6	98		97.3	95.3		90			80			68.8			53.9			95
100	97.9	94		96.1	91		89.4	86.7		79.7			68.8			53.9			100
105	94.2	89.4		92.5	86.6		88.9	83.1		79.4	78.1		68.7			53.8			105
110	89.8	85.2		88.2	82.5		86.1	79.2		79.1	75.9		68.5	66		53.8			110
115	85.7	81.3	77.2	84.2	78.9		82.5	75.6		78.6	72.4		68.4	65.7		53.7			115
120	81.6	77.7	73.7	80.6	75.5		79	72.2		76.9	69.1		68.2	64.6		53.6	51.9		120
125	76.9	74.2	70.4	77.2	72.2	67.4	75.6	69.1		74.2	66.2		68.1	62.1		53.6	51.9		125
130	72.1	70.7	67.1	73.6	69	64.5	72.2	66.2	60.8	71.1	63.4		67.9	59.7		53.6	51.7		130
135	67.2	67.5	64	70.3	65.9	61.5	69	63.4	58.8	68.2	61.5		66.2	58.3		53.6	51.2		135
140	61.2	64.5	61.1	67.1	63	58.8	66	60.6	56.3	65.2	59	52.9	63.5	56		53.6	50.6		140
145	55	61.7	58.5	61.4	60.2	56.2	63.1	58.5	53.9	62.3	56.4	50.6	61.3	53.7		53.6	49.7		145
150	48.5	59.1	56	54.9	57.7	53.8	59.6	56.2	51.5	59.3	54	48.4	58.8	51.4	44.6	53.6	48.6		150
155		56.7	53.7	47.5	55.3	51.6	53.4	53.9	49.4	56.8	51.8	46.3	56.3	49.3	42.7	53.5	46.7	28	155
160		52.7	51.6		53.1	49.5	44.2	51.7	47.4	52.6	49.7	44.4	53.4	47.2	40.9	52.5	44.7	37.4	160
165			49.5		50.9	47.5		49.6	45.5		47.6	42.6		45.3	39.2	50.5	42.9	35.8	165
170			47.6			45.7		47.7	43.7		45.8	40.9		43.5	37.6		41.2	34.3	170
175						43.9			42		44	39.3		41.8	36.1		39.5	32.9	175
180						42.2			40.3			37.7		40.2	34.6		38	31.6	180
185									38.8			36.3			33.3		36.5	30.3	185
190												34.9			32			29.1	190
195															30.8			27.9	195
200															29.6			26.8	200
205																		25.8	205

* adapter - piece d'adaptateur

	157 ft + 13 ft*			174 ft + 13 ft*			191 ft + 13 ft*			209 ft + 13 ft*			226 ft + 13 ft*	
	83°	75°	67°	83°	75°	67°	83°	75°	67°	83°	75°	67°	83°	
80	41.4			28.9										80
85	41.2			30.8						21.6				85
90	40.8			30.6						21.5			5.3	90
95	40.5			30.3						21.3			5.1	95
100	40.1			30.1						21.1			4.9	100
105	39.7			29.8						20.9			4.7	105
110	39.3			29.5						20.7			4.5	110
115	38.9			29.2						20.5			4.3	115
120	38.5			28.9						20.3			4.1	120
125	38.1	33.5		28.6						20.1			3.9	125
130	37.6	32.8		28.3						19.9			3.7	130
135	37.1	32.1		28	23.9					19.7			3.5	135
140	36.6	31.4		27.7	23.3					19.5	16.6		3.4	140
145	36.1	30.7		27.4	22.6					19.4	16.2		3.2	145
150	35.6	30		27.2	21.9					19.2	15.7			150
155	35	29.3		26.9	21.1					19	15.2			155
160	33.5	28.6		26.7	20.4					18.9	14.7			160
165	32.6	27.9		26.5	19.8					18.7	14.2			165
170		27.3	23.2	26.4	19.1					18.6	13.7			170
175		26.7	22.5		18.6	14.5					13.2			175
180		26.2	21.7		18.1	14.1					12.8			180
185		25.7	21		17.7	13.5					12.3			185
190		25.3	20.3		17.2	12.9					11.9	8.1		190
195			19.6		16.8	12.4					11.5	7.8		195
200			19.1			11.9					11.2	7.5		200
205			18.5			11.4						7.2	7.4	205
210			18.1									6.9		210
215												6.6		215
220												6.3		220
225												6		225

* adapter - piece d'adaptateur

Lifting capacities

Forces de levage

TN 161

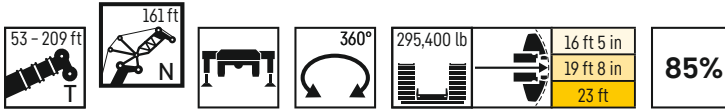

	53 ft + 13 ft*			70 ft + 13 ft*			87 ft + 13 ft*			105 ft + 13 ft*			122 ft + 13 ft*			139 ft + 13 ft*			157 ft + 13 ft*			174 ft + 13 ft*			191 ft + 13 ft*			209 ft + 13 ft*		
	83°	75°	67°	83°	75°	67°	83°	75°	67°	83°	75°	67°	83°	75°	67°	83°	75°	67°	83°	75°	67°	83°	75°	67°	83°	75°	67°	83°	75°	
65	97.9			92.5																										65
70	96.7			91.8			84			71.9																				70
75	95.6			91.1			83.5			73.8			61.5																	75
80	94.4			90.3			82.9			73.5			61.6		48.5			37.4												80
85	93.3			89.6			82.4			73.1			61.7		48.5			37.3			27.5									85
90	92.3			88.8			81.8			72.7			61.9		48.6			37.1			27.3			18.4						90
95	91.1	89.4		88.1			81.3			72.4			61.9		48.6			36.8			27.1			18.1			9.6			95
100	89.9	88.3		87.4	85.6		80.7			72			61.9		48.6			36.4			26.9			17.9			9.4			100
105	88.6	87.2		86.7	84.2		80.3	79.1		71.7			62		48.5			36.1			26.7			17.6			9.1			105
110	87.3	83.6		85.6	80.5		79.8	76.6		71.4	70.3		61.9		48.5			35.8			26.5			17.4			8.9			110
115	84.2	79.8		82.4	76.9		79.3	74.1		71.2	70		61.7	59.8			48.4			35.4			26.2			17.2		8.7		115
120	80.5	76.3	72.3	78.8	73.5		76.8	70.8		70.9	67.3		61.6	59.6			48.4			35.1			25.9			17		8.5		120
125	77.1	73	69.1	75.5	70.7		73.7	67.7		70.2	64.4		61.5	59.2		48.3	46.8		34.7			25.7			16.9		8.3			125
130	73.5	69.9	66.2	72.4	67.9	63.3	71.2	64.9		69.1	61.7		61.4	57.8		48.3	46.7		34.4	30.4		25.4			16.7		8.2			130
135	69.4	67	63.5	69.5	65.2	60.7	68.4	62.3		66.6	59.2		61.4	55.4		48.3	46.6		34	29.6		25.2			16.6		8			135
140	65.3	64	60.6	66.5	62.5	58.2	65.5	59.8	55	64.1	57.2		61.4	53.6		48.3	46.4		33.6	29		24.9	21.5		16.4		7.8			140
145	61.1	61.3	57.9	63.6	59.8	55.7	62.4	57.5	52.9	61.6	55.3	49.3	59.7	52.3		48.3	46.2		33.2	28.4		24.7	20.9		16.3	12.9	7.7			145
150	55.9	58.7	55.5	60.6	57.3	53.3	59.8	55	50.7	59.1	53.2	47.4	57.4	50.3		48.3	45.7		32.8	27.8		24.4	20.3		16.3	14.1	7.6			150
155	50.5	56.2	53.2	55.6	54.9	51.1	57.3	53.1	48.5	56.9	51	45.4	55.4	48.4	41.7	48.3	45		32.3	27.1		24.2	19.7		16.2	13.7	7.4	6.3		155
160	45	54	51	50.2	52.7	49	54.2	50.9	46.5	53.9	48.9	43.5	53.4	46.4	39.9	48.3	43.8		31.9	26.5		24	19.1		16.1	13.3	7.3	6.1		160
165	38.5	51.9	49	44.2	50.6	47	49.1	48.9	44.6	51.7	46.9	41.7	51.2	44.5	38.2	48.2	42.1	34.8	31.4	25.9		23.7	18.5		16.1	12.8	7.2	5.9		165
170		49.1	47.1		48.6	45.1	42.6	47	42.8	48.6	45	40	49.1	42.7	36.7	47.5	40.3	33.3	30.1	25.3		23.5	17.8		16.1	12.3	7.2	5.8		170
175			45.3		46.7	43.4		45.2	41.2		43.3	38.4	45	41	35.2	46.2	38.7	31.9	29.2	24.7	21.1	23.4	17.2		16.1	11.9	7.2	5.6		175
180			43.6		44.1	41.7		43.4	39.6		41.6	36.9		39.4	33.8		37.2	30.6	27.9	24.2	20.3	23.3	16.7		16.1	11.5	7.1	5.5		180
185						40.2		41.8	38.1		40	35.5		37.9	32.4		35.8	29.4		23.6	19.6		16.1	12.4		11.1	7.1	5.4		185
190						38.6			36.6			34.1		36.5	31.1		34.4	28.2		23.2	18.9		15.7	11.9		10.7		5.2		190
195									35.2			32.8			29.9		33.1	27.1		22.7	18.3		15.3	11.4		10.4	6.8	5.1		195
200												31.6			28.8			26		22.4	17.7		15	11		10.1	6.6	5.1		200
205												30.4			27.7			25			17.2		14.6	10.6		9.8	6.3	5		205
210															26.6			24			16.6			10.2		9.5	6	5		210
215																		23			16.2			9.9			5.7	5		215
220																					15.7			9.6			5.4			220
225																					15.4			9.3			5.1			225
230																								9			4.9			230
235																										4.6				235

* adapter - piece d'adaptateur

Lifting capacities

Forces de levage

TN 172

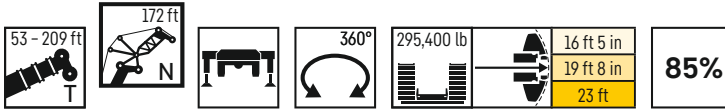

	53 ft + 13 ft*			70 ft + 13 ft*			87 ft + 13 ft*			105 ft + 13 ft*			122 ft + 13 ft*			139 ft + 13 ft*			157 ft + 13 ft*			174 ft + 13 ft*			191 ft + 13 ft*			209 ft + 13 ft*			
	83°	75°	67°	83°	75°	67°	83°	75°	67°	83°	75°	67°	83°	75°	67°	83°	75°	67°	83°	75°	67°	83°	75°	67°	83°	75°	67°	83°	75°		
70	87.1			82.4																										70	
75	86.1			81.8			75.2					66.5																		75	
80	85.1			81.1			74.7					66.3			55.5			43.8												80	
85	84.1			80.5			74.2					66			55.5			43.8			33.8									85	
90	83.2			79.8			73.7					65.6			55.5			43.9			33.7			24.8						90	
95	82.3			79.2			73.2					65.3			55.5			43.9			33.6			24.7			15.5			95	
100	81.3	79.9		78.5			72.7					65			55.5			43.9			33.3			24.5			15.3			100	
105	80.4	79		77.7	76.7		72.2					64.6			55.5			43.8			33.1			24.3			15			105	
110	79.5	78.1		76.7	76		71.7	71.1				64.3			55.5			43.8			32.8			24.1			14.8			110	
115	78.6	77.2		75.8	75.3		71.2	70.6				64.1	62.9		55.5			43.7			32.5			23.9			14.6			115	
120	77.1	74.9		74.8	72.5		70.7	68.8				63.8	62.8		55.4	53.8		43.7			32.2			23.7			14.4			120	
125	74.6	71.6		73.2	69.3		70.1	66.4				63.6	62.6		55.4	54		43.7			31.9			23.4			14.2			125	
130	71.9	68.6	65	71.2	66.5		68.6	63.6				63.1	60.4		55.3	54		43.6	42.3		31.6			23.2			14			130	
135	69.3	65.9	62.3	68.6	63.8	59.5	66.9	61				62.2	57.9		54.9	53.8		43.6	42.2		31.3	27.9		23			13.9			135	
140	66.2	63.2	59.8	65.9	61.4	57.1	64.3	58.6				61.3	55.6		54.4	52.6		43.6	42.1		30.9	27.2		22.8			13.7			140	
145	62.7	60.8	57.4	63.4	59	54.9	62.1	56.4	51.6			60.3	53.5		53.9	50.5		43.6	42.1		30.6	26.5		22.6	19.5		13.5			145	
150	59.2	58.3	55	60.9	56.8	52.8	59.8	54.3	49.8			58.2	51.6		53.4	48.6		43.6	42		30.3	25.9		22.3	19		13.4	11.9		150	
155	55.5	55.9	52.8	58.5	54.5	50.7	57.3	52.3	48			56.2	50.2	44.6	52.6	47.9		43.6	41.9		30	25.3		22.1	18.5		13.3	11.7		155	
160	51	53.6	50.6	55.9	52.3	48.6	55	50.2	46.1	54	48.4	42.9	51.8	46.2	39.7	43.6	41.4			29.6	24.8		21.9	18		13.2	11.6		5.2	4.1	160
165	46.4	51.5	48.6	51.6	50.2	46.6	52.8	48.5	44.2	52.1	46.5	41.2	50.8	44.5	38.3	43.6	40.9			29.2	24.3		21.7	17.4		13.1	11.4		5	3.9	165
170	41.6	49.5	46.7	46.9	48.3	44.8	50.3	46.6	42.4	49.9	44.6	39.6	48.8	42.8	36.7	43.6	39.9	32.9		28.9	23.8		21.5	16.8		13.1	11.2		4.9	3.7	170
175	36.4	47.6	44.9	41.7	46.4	43	46.1	44.8	40.7	47.5	42.9	38	47	41.1	35.2	43.6	38.4	31.5		28.4	23.3		21.3	16.3		13.1	11		4.9	3.6	175
180		45.8	43.2	35.3	44.7	41.4	40.7	43.1	39.2	45.3	41.3	36.5	45.2	39.5	33.8	43.1	36.9	30.2	27.3	22.8	19.3		21.2	15.8		13.1	10.7		4.8	3.5	180
185		40.2	41.6		43	39.8		41.5	37.7	38.6	39.7	35.1	42.1	38	32.4	42.3	35.4	28.9	26.6	22.2	18.7		21.1	15.3		13.1	10.4		4.8	3.3	185
190				40.1		41.4	38.4		40	36.3		38.2	33.7		36.6	31.2		34.1	27.8	25.9	21.7	18.1	21	14.8	11.2	13.1	10.1		4.7	3.2	190
195				38.7			37		38.5	34.9		36.8	32.4		35.2	30		32.8	26.6		21.3	17.5		14.3	10.8	13.1	9.8		4.7		195
200							35.6			33.6		35.5	31.2		33.9	28.8		31.5	25.6		20.9	16.9		13.9	10.4		9.5				200
205										32.4			30.1		32.6	27.7		30.3	24.6		20.5	16.3		13.6	10		9.2	5.7			205
210													29			26.6		29.2	23.6		20.3	15.8		13.2	9.7		8.9	5.5			210
215													27.9			25.6			22.7			15.3		12.9	9.3		8.6	5.2			215
220																24.7			21.8			14.8			9		8.4	4.9			220
225																		20.9			14.4				8.7			4.7			225
230																			20.1			14				8.4			4.4		230
235																						13.7				8.1			4.2		235
240																										7.9			3.9		240
245																												3.7			245
250																												3.4			250

* adapter - piece d'adaptateur

Lifting capacities

Forces de levage

TN 184

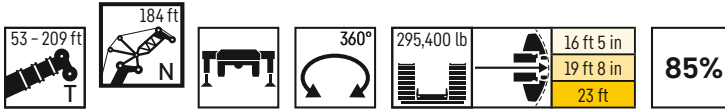

	53 ft + 13 ft*			70 ft + 13 ft*			87 ft + 13 ft*			105 ft + 13 ft*			122 ft + 13 ft*			139 ft + 13 ft*			157 ft + 13 ft*			174 ft + 13 ft*			191 ft + 13 ft*			209 ft + 13 ft*	
	83°	75°	67°	83°	75°	67°	83°	75°	67°	83°	75°	67°	83°	75°	67°	83°	75°	67°	83°	75°	67°	83°	75°	67°	83°	75°	67°	83°	
70	79																											70	
75	78.2			74.1			68.2																					75	
80	77.4			73.5			67.7			59.9																		80	
85	76.6			72.9			67.2			59.8			50.3		39.5													85	
90	75.7			72.3			66.8			59.5			50.3		39.5			30.2										90	
95	74.7			71.6			66.3			59.1			50.4		39.5			30.2			21.4				12.8			95	
100	73.8			70.8			65.8			58.8			50.4		39.5			30.1			21.1				12.5		5.1	100	
105	72.8	72		70			65.3			58.5			50.4		39.5			29.8			20.9				12.3		4.8	105	
110	70.7	71.2		68.8	69.1		64.8			58.2			50.4		39.4			29.6			20.7				12		4.6	110	
115	68.6	70.4		67	68.4		63.7	63.9		57.8			50.3		39.4			29.4			20.4				11.8		4.4	115	
120	66.5	69.1		65.2	67.5		62.3	63.5		57.1	56.4		50.1		39.3			29.1			20.2				11.6		4.2	120	
125	64.4	67.2		63.4	66.5		61	62.9		56.4	56.5		49.7	48.4		39.3			28.8		20				11.4		4	125	
130	62.3	65.2		61.6	64.5		59.7	61.4		55.7	56.4		49.3	48.6		39.3			28.6		19.8				11.2		3.8	130	
135	60.1	63.2	61	59.6	62.1		58.1	59.4		54.9	56		49	48.7		39.2	37.9		28.3		19.6				11		3.6	135	
140	58	61.1	58.6	57.7	59.7		56.5	57		53.8	54		48.5	48.7		39.2	37.8		28	25.1	19.5				10.8		3.5	140	
145	55.9	59.1	56.3	55.8	57.4	53.3	54.8	54.8		52.5	51.9		47.6	48.4		39.2	37.7		27.8	24.5	19.3				10.6		3.3	145	
150	54	57.1	54.2	53.9	55.2	51.3	53.1	52.8	47.8	51.2	50		46.7	47.1		39.2	37.6		27.5	23.9	19.2	17.2			10.5		3.1	150	
155	52.1	55.2	52.2	52.1	53.3	49.4	51.5	50.8	46.5	49.9	48.1		45.8	45.4		39.2	37.5		27.2	23.3	19.1	16.9			10.3	9		155	
160	50.3	53.2	50.1	50.4	51.4	47.6	50	49	44.7	48.6	46.6	42	44.9	43.7		39.2	37.5		26.9	22.7	19.1	16.4			10.2	8.8		160	
165	48.2	51	48.1	48.6	49.5	45.8	48.4	47.3	43.1	47.3	45.7	40.4	43.9	43.1		39	37.3		26.6	22.2	19	15.9			10.1	8.6		165	
170	45.2	49	46.2	46.6	47.5	44	46.8	45.5	41.5	46	44.2	39	42.9	41.6	35.5	38.5	37.1		26.4	21.8	18.9	15.4			10	8.5		170	
175	42	47.2	44.4	44.3	45.7	42.2	45.3	44	39.9	44.7	42.5	37.5	42	40.2	34.2	38.1	36.8	20.7	26	21.3	18.8	15			10	8.3		175	
180	38.6	45.4	42.7	42	44	40.6	43.8	42.4	38.3	43.3	40.9	36	41	38.7	32.9	37.6	36	29.2	25.7	20.9	18.7	14.5			9.9	8.2		180	
185	34.2	43.7	41.1	38.5	42.3	39.1	41.8	40.8	36.8	42.2	39.3	34.6	40.1	37.2	31.5	37.1	34.6	28	25.4	20.4	18.6	14			9.9	8.1		185	
190	27.7	42.1	39.6	33.9	40.8	37.6	37.7	39.2	35.4	40.4	37.9	33.3	39.2	35.8	30.3	36.6	33.3	26.8	24.4	20	16.7	18.5	13.5			9.9	8		190
195		37.8	38.2		39.3	36.2		37.8	34.1	36.4	36.5	32	37.7	34.5	29.1	36.1	32	25.7	23.7	19.5	16.1	18.5	13.1			9.9	7.9		195
200			36.8		37.9	34.9		36.4	32.8		35.1	30.8		33.2	27.9	35.4	30.8	24.7	23.4	19.1	15.6	18.4	12.7	9.4		9.9	7.8		200
205			35.5			33.6		35.1	31.6		33.8	29.6		32	26.9		29.6	23.7	18.7	15	18.4	12.2	9.1	9.9		9.9	7.7		205
210						32.4			30.5		32.6	28.5		30.8	25.8		28.5	22.7	18.3	14.5		11.8	8.7		7.6	4.5		210	
215									29.4		27.5	27.5		29.6	24.8		27.4	21.8	17.9	14		11.5	8.4		7.5	4.3		215	
220									28.3			26.4			23.9		26.4	20.9	17.7	13.5		11.2	8.1		7.4	4		220	
225											25.5			23			20.1	17.5	13.1		11	7.8		7.2	3.8			225	
230														22.1			19.3			10.8	7.5		7	3.5				230	
235																	18.5				7.2		6.8	3.2				235	
240																	17.8				7							240	
245																					6.7							245	
250																					6.4							250	
255																					6.2							255	

* adapter - piece d'adaptateur

Lifting capacities

Forces de levage

TN 195

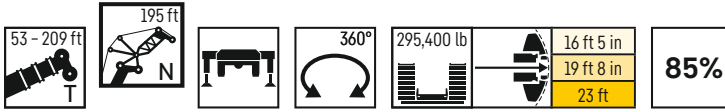

	53 ft + 13 ft*			70 ft + 13 ft*			87 ft + 13 ft*			105 ft + 13 ft*			122 ft + 13 ft*			139 ft + 13 ft*			157 ft + 13 ft*			174 ft + 13 ft*			191 ft + 13 ft*			209 ft + 13 ft*	
	83°	75°	67°	83°	75°	67°	83°	75°	67°	83°	75°	67°	83°	75°	67°	83°	75°	67°	83°	75°	67°	83°	75°	67°	83°	75°	67°	83°	
75	68.5																											75	
80	67			65.3			62.1																					80	
85	65.4			63.9			61.1			55.1			46.3															85	
90	63.7			62.6			60.1			54.9			46.3			36.3												90	
95	62			61.3			59			54.6			46.4			36.4			27.8			19.5						95	
100	60.3			59.8			57.9			54.1			46.4			36.3			27.8			19.2			11.1			100	
105	58.5			58.4			56.9			53.6			46.5			36.3			27.7			19			10.8		3.8	105	
110	56.8	59.5		56.9			55.8			52.9			46.5			36.3			27.5			18.8			10.6		3.6	110	
115	55	57.8		55.3	58.1		54.7			52.1			46.4			36.2			27.4			18.6			10.4		3.4	115	
120	53.3	56.3		53.6	56.9		53.3	55.5		51.3			46.4			36.2			27.1			18.3			10.2		3.2	120	
125	51.5	54.8		51.9	55.6		51.8	54.6		50.4	51.9		46.2			36.2			26.9			18.2			10			125	
130	49.8	53		50.2	54.2		50.2	53.7		49.4	51.2		45.8			36.1			26.7			18			9.8			130	
135	48.1	51.1		48.5	52.5		48.7	52.7		48.4	50.6		45.5	44.6		36.1			26.4			17.8			9.6			135	
140	46.5	49.4	52.1	46.9	50.7		47.2	51.3		47.4	49.9		45.1	44.7		36.1	34.8		26.2			17.6			9.4			140	
145	44.9	47.7	50.5	45.3	48.9		45.7	49.8		46.2	49.2		44.7	44.8		36	34.7		25.9	23.4		17.5			9.3			145	
150	43.3	46	48.7	43.8	47.3	50.4	44.2	48.2		44.8	48.4		43.9	44.8		36	34.7		25.7	22.9		17.3			9.1			150	
155	41.8	44.4	47	42.3	45.7	48.5	42.8	46.7		43.4	47.6		42.8	44.4		36	34.6		25.5	22.4		17.2	15.4		9			155	
160	40.5	43	45.4	40.9	44.1	46.8	41.4	45.1	44.1	42	46.3		41.7	43.1		36	34.6		25.2	21.9	42	17.1	15.2		8.8	7.5		160	
165	39.3	41.6	43.9	39.7	42.6	45.3	40.2	43.6	42.9	40.7	44.6	39.9	40.6	41.6		36	34.6		25	21.3	40	17	15		8.7	7.3		165	
170	38.1	40.2	42.5	38.5	41.3	43.7	39	42.3	41.5	39.5	43.1	38.5	39.5	40.1		36	34.6		24.8	20.8	38	17	14.8		8.6	7.1		170	
175	36.9	38.9	41.1	37.2	39.9	42.2	37.9	41	40.1	38.4	41.7	37.1	38.5	39.7	33.8	35.9	34.5		24.6	20.3	36	17	14.4		8.5	7		175	
180	35.9	37.8	39.8	36.2	38.7	40.6	36.7	39.8	38.7	37.2	40.5	35.9	37.5	38.4	32.6	35.5	34.3		24.3	19.9	34	16.9	14		8.4	6.8		180	
185	34.9	36.7	38.6	35.2	37.6	39	35.8	38.7	37.2	36.2	39.3	34.6	36.4	37.1	31.5	35.2	34.1	27.8	24	19.5	32	16.9	13.5		8.3	6.7		185	
190	33.9	35.6	37.4	34.2	36.5	37.6	34.8	37.6	35.8	35.2	37.9	33.3	35.5	35.8	30.3	34.8	33.2	26.8	23.8	19.1	30	16.9	13.1		8.3	6.6		190	
195	31.1	34.7	36.4	32.9	35.5	36.2	33.9	36.6	34.5	34.3	36.5	32	34.6	34.5	29.1	34.3	32	25.7	23.5	18.8	28	16.9	12.7		8.3	6.5		195	
200	27.1	33.8	35.4	31.1	34.5	34.9	32.6	35.5	33.2	33.4	35.2	30.8	33.7	33.2	27.9	33.6	30.8	24.6	22.4	18.4	25.3	16.9	12.2		8.3	6.4		200	
205		32.8	34.4		33.6	33.6	29.9	34.6	32	32.6	33.9	29.6	32.9	32	26.9	32.8	29.6	23.6	21.4	18	23.6	16.9	11.9	8.8		8.3	6.3		205
210			33.5		32.8	32.4		33.7	30.8		32.7	28.5	32.1	30.8	25.8	32.2	28.5	22.7	20.8	17.6	22.7	16.9	11.5	8.5		8.3	6.2		210
215			32.8		31.3		32.9	29.7			31.5	27.5		29.7	24.9		27.5	21.8		17.3	13.8	16.8	11.1	8.2		8.3	6.2	3.6	215
220					30.2			28.7			30.4	26.5		28.7	23.9		26.5	20.9		17	13.4		10.8	7.9		6.2	3.5		220
225					29.2			27.7				25.5		27.6	23		25.5	20.1		16.7	13		10.5	7.6		6.1	3.4		225
230								26.7				24.6			22.2		24.6	19.3		16.5	12.5		10.3	7.3		6.1	3.2		230
235												23.7			21.3			18.5		16.3	12.2		10.1	7		6.1			235
240															20.5			17.8			11.8		9.9	6.8		6.1			240
245															19.8			17.1			11.4			6.5		6.1			245
250																		16.4			11.1			6.3					250
255																					10.9			6					255
260																								5.8					260
265																								5.5					265

* adapter - piece d'adaptateur

Lifting capacities

Forces de levage

TN 207

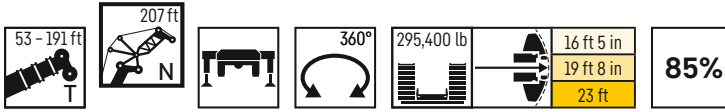

	53 ft + 13 ft*			70 ft + 13 ft*			87 ft + 13 ft*			105 ft + 13 ft*			122 ft + 13 ft*			139 ft + 13 ft*			157 ft + 13 ft*			174 ft + 13 ft*			191 ft + 13 ft*					
	207 ft																													
	83°	75°	67°	83°	75°	67°	83°	75°	67°	83°	75°	67°	83°	75°	67°	83°	75°	67°	83°	75°	67°	83°	75°	67°	83°	75°				
80	63.3			61.2																								80		
85	62			60.3			56.3			50																		85		
90	60.8			59.2			55.9			49.8			41.8															90		
95	59.5			58.1			55.3			49.7			41.8			32.7			24.9									95		
100	58.3			57.1			54.6			49.4			41.9			32.7			24.7			16.3						100		
105	57.1			56			53.8			49.1			41.9			32.6			24.5			16			8.4			105		
110	55.9			55			53			48.8			42			32.6			24.2			15.8			8.2			110		
115	54.7	56.1		53.9			52.1			48.5			41.9			32.5			24			15.6			8			115		
120	53.4	55		52.8	54.3		51.3			48.2			41.8			32.5			23.8			15.3			7.8			120		
125	52.1	53.9		51.7	53.4		50.4	51.8		47.9			41.8			32.5			23.6			15.1			7.5			125		
130	50.7	52.9		50.5	52.5		49.5	51		47.4	46.7		41.7			32.4			23.4			14.9			7.3			130		
135	49.4	51.7		49.3	51.6		48.6	50.3		46.8	46.8		41.6			32.4			23.2			14.7			7.2			135		
140	48	50.5		48.2	50.6		47.8	49.5		46.2	46.7		41.5	40.1		32.4			23			14.5			7			140		
145	46.6	49.2		46.9	49.5		47	48.8		45.6	46.5		41.4	40.2		32.3	30		22.9			14.4			6.8			145		
150	45.2	47.7	50	45.5	48.5		45.9	48.1		45	46.1		41.3	40.3		32.3	29.9		22.8	20.7		14.2			6.6			150		
155	43.8	46.3	48.6	44.2	47.2	47	44.7	47.3		44	45.6		41.2	40.3		32.3	29.8		22.6	20.4		14.1			6.5			155		
160	42.3	44.7	47	42.9	45.7	45.9	43.4	46.3		43	44.7		40.7	40.3		32.3	29.7		22.5	20		13.9	12.3		6.3			160		
165	41	43.3	45.6	41.6	44.3	44.3	42.1	45.1	41.1	42	43.2		40.2	40		32.3	29.7		22.4	19.6		13.8	12.1		6.1	4.9		165		
170	39.9	42	44.2	40.5	43	42.8	40.8	44	39.8	40.9	41.7		39.8	38.7		32.3	29.7		22.2	19.1		13.7	12		6	4.8		170		
175	38.8	40.8	42.9	39.4	41.9	41.3	39.8	42.6	38.7	39.9	40.3	35.8	39.3	37.4		32.3	29.7		22.1	18.6		13.6	11.9		5.9	4.6		175		
180	37.7	39.6	41.6	38.3	40.8	39.9	38.7	41.2	37.4	38.9	39	34.5	38.6	36.1	31.2	32.3	29.7		21.9	18.1		13.6	11.7		5.8	4.4		180		
185	36.5	38.5	40.3	37.2	39.6	38.6	37.7	39.9	36.2	37.9	38.1	33.3	37.7	35.7	30.1	32.3	29.7		21.8	17.8		13.5	11.6		5.6	4.3		185		
190	35.1	37.5	38.8	36.2	38.5	37.1	36.6	38.6	35	36.9	36.9	32.2	36.8	34.6	29.1	32.3	29.7	25.5	21.6	17.4		13.5	11.5		5.5	4.1		190		
195	33.7	36.5	37.4	35.1	37.5	35.8	35.7	37.5	33.7	35.9	35.7	31.1	35.9	33.5	28.1	32.3	29.7	24.6	21.3	17.1		13.5	11.3		5.5	4		195		
200	32.3	35.5	36	34.2	36.6	34.4	34.8	36.1	32.4	35.1	34.4	29.9	35.1	32.4	27	32.3	29.7	23.7	21.1	16.7	14	13.5	11		5.4	3.8		200		
205	29.2	34.6	34.8	32.6	35.6	33.2	34	34.8	31.2	34.2	33.1	28.8	34.3	31.2	26	32.3	28.8	22.8	20.8	16.4	13.5	13.5	10.7		5.4	3.7		205		
210	25.7	33.8	33.5	29.4	34.7	32	31.9	33.5	30	33.4	32	27.7	33.6	30.1	25	32.2	27.8	21.8	19.9	16	13.1	13.5	10.4	7.5	5.4	3.6		210		
215		31.8	32.4		33.7	30.9	28.7	32.4	29	31.3	30.8	26.7	32.5	29	24	31.8	26.7	20.9	19	15.7	12.6	13.5	10.1	7.3	5.4	3.5		215		
220			31.2		32.5	29.8		31.2	27.9		29.7	25.7		29.7	25.7	30.8	27.9	23.1	31	25.7	20.1	18.6	15.4	12.1	13.5	9.8	7	5.4	3.4	220
225			30.2		30.1	28.7		30.1	26.9		28.7	24.7		28.7	24.7		26.9	22.2		24.8	19.2	17.2	15.1	11.7	13.5	9.5	6.7	5.4	3.4	225
230						27.7		29.1	26		27.7	23.8		26	21.3		23.8	18.4		14.8	11.3		9.2	6.4	5.4	3.3		230		
235						26.8			25		26.7	23		25	20.5		23	17.7		14.5	11		9	6.1		3.3		235		
240									24.1			22.1			19.7		22.1	17		14.3	10.6		8.8	5.9		3.2		240		
245												21.3			19			16.3		14.2	10.4		8.6	5.6		3.2		245		
250												20.5			18.2			15.6			10.1		8.4	5.4		3.2		250		
255															17.5			15			9.8			5.1		3.2		255		
260																		14.3			9.6			4.9				260		
265																					9.4			4.6				265		
270																					9.2			4.4				270		
275																							4.1					275		

* adapter - piece d'adaptateur

Lifting capacities

Forces de levage

TN 218

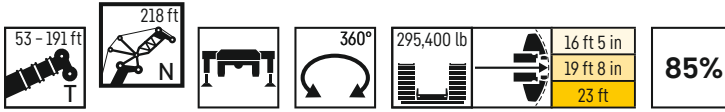

	53 ft + 13 ft*			70 ft + 13 ft*			87 ft + 13 ft*			105 ft + 13 ft*			122 ft + 13 ft*			139 ft + 13 ft*			157 ft + 13 ft*			174 ft + 13 ft*			191 ft + 13 ft*	
	83°	75°	67°	83°	75°	67°	83°	75°	67°	83°	75°	67°	83°	75°	67°	83°	75°	67°	83°	75°	67°	83°	75°	67°	83°	
85	55.2			53.7																					85	
90	54.2			52.8																						90
95	53.2			52																						95
100	52.2			51.1																						100
105	51.2			50.3																						105
110	50.2			49.4																						110
115	49.3			48.6																						115
120	48.3	49.4		47.8																						120
125	47.5	48.5		46.9	48																					125
130	46.6	47.7		46.2	47.3																					130
135	45.8	46.8		45.5	46.5																					135
140	45	46		44.7	45.8																					140
145	44.2	45.3		44	45.1																					145
150	43.5	44.5		43.3	44.5																					150
155	42.8	43.8	44.5	42.7	43.8																					155
160	42.1	43.2	43.9	42.1	43.1																					160
165	41.4	42.5	43.2	41.5	42.6	43																				165
170	40.7	41.9	42.6	40.9	42	41.5																				170
175	39.9	41.2	42	40.3	41.4	40.3																				175
180	38.9	40.3	40.8	39.4	40.8	38.9																				180
185	38	39.4	39.5	38.5	40.1	37.6																				185
190	37	38.6	38.2	37.6	39.3	36.4																				190
195	35.8	37.7	36.9	36.6	38.3	35.2																				195
200	33.9	36.8	35.5	35.4	37.1	34																				200
205	31.8	36	34.2	34	35.7	32.7																				205
210	29.7	35	33	32.6	34.5	31.5																				210
215	27	33.8	31.9	30.8	33.3	30.4																				215
220	23.8	32.5	30.8	27.6	32.1	29.3																				220
225		30.4	29.7	23.8	31	28.3																				225
230		26.7	28.7		29.9	27.3																				230
235			27.7		28.6	26.3																				235
240					25.4	26.8																				240
245					24.5																					245
250						22.9																				250
255						22.1																				255
260																										260
265																										265
270																										270
275																										275
280																										280

* adapter - piece d'adaptateur

Lifting capacities

Forces de levage

TN 230

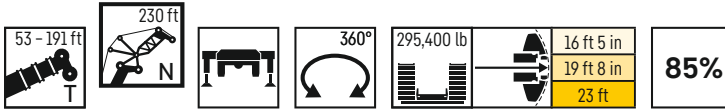

	53 ft + 13 ft*			70 ft + 13 ft*			87 ft + 13 ft*			105 ft + 13 ft*			122 ft + 13 ft*			139 ft + 13 ft*			157 ft + 13 ft*			174 ft + 13 ft*			191 ft + 13 ft*	
	83°	75°	67°	83°	75°	67°	83°	75°	67°	83°	75°	67°	83°	75°	67°	83°	75°	67°	83°	75°	67°	83°	75°	67°	83°	
85	51.7																								85	
90	50.9			49.3																						90
95	50.1			48.7																						95
100	49.3			48																						100
105	48.5			47.3																						105
110	47.7			46.6																					4	110
115	46.9			45.9																					3.8	115
120	46.2			45.2																					3.6	120
125	45.4	46.1		44.6																					3.4	125
130	44.7	45.4		43.9	44.6																				3.2	130
135	44	44.8		43.3	44.1																					135
140	43.4	44.1		42.7	43.5																					140
145	42.7	43.4		42.1	42.9																					145
150	42.1	42.8		41.6	42.4																					150
155	41.4	42.3		41	41.8																					155
160	40.9	41.7	42.1	40.5	41.3																					160
165	40.4	41.1	41.6	40	40.8																					165
170	39.9	40.6	41.1	39.5	40.3	40.1																				170
175	39.4	40.1	40.6	39.1	39.9	38.7	38.3	39	16.5	36.8	36.9															175
180	38.9	39.6	40	38.6	39.4	37.4	38	38.4	34.6	36.5	36.5															180
185	38.4	39.2	38.7	38.1	39	36.3	37.6	37.6	33.4	36.3	35.3	30.3	32.5	30												185
190	37.8	38.8	37.4	37.7	38.2	35.1	37.2	36.3	32.3	36	34.1	29.7	32.5	30												190
195	37.3	38.4	36.2	37.2	37	34	36.8	35.2	31.5	35.8	33	28.9	32.5	30	24.7											195
200	36.7	37.5	35	36.7	36	32.9	36.4	34	30.6	35.6	32	27.9	32.5	29.5	24.6	22.5	20.5									200
205	35.6	36.3	33.8	36.2	34.9	31.8	36	33	29.6	35.4	31	27	32.5	28.5	24.1	22.5	20.5	18.1								205
210	33.2	35	32.6	34.8	33.7	30.7	35.6	32	28.6	35	30.4	26.1	32.5	27.6	23.3	22.5	20.4	18	14.6	12.5						210
215	30.6	33.8	31.5	32.6	32.5	29.6	33.9	31.1	27.7	33.9	29.5	25.3	32.4	27.3	22.5	22.5	20.4	17.9	14.6	12.4	10.3					215
220	27.9	32.6	30.3	30.5	31.4	28.6	32.1	30.1	26.6	32.8	28.5	24.4	31.6	26.6	21.7	22.5	20.4	17.9	14.6	12.2	10.2					220
225	25.2	31.5	29.3	28.2	30.3	27.5	30.3	29	25.7	31.4	27.5	23.4	30.5	25.7	20.9	22.5	20.4	17.9	14.6	12	9.9				3.4	225
230	22.3	30.4	28.3	25.4	29.3	26.5	28.1	28	24.7	30.2	26.5	22.5	29.5	24.8	20	22.5	20.4	17.7	14.5	11.8	9.6					230
235	18	28.5	27.3	22.3	28.3	25.6	25.2	27	23.8	27.9	25.6	21.7	28.4	23.8	19.2	22.5	20.4	16.9	14.3	11.7	9.3					235
240		25.2	26.3		27.3	24.7		26.1	23	24.6	24.6	20.9	27.3	23	18.4	22.5	20.4	16.2	14.3	11.5	9					240
245			25.4		26.4	23.8		25.2	22.1		23.8	20.1		22.1	17.7	22.5	20.4	15.5	13.9	11.3	8.7					245
250			24.6			23		24.3	21.3		22.9	19.3		21.3	17		19.9	14.8		11.1	8.5					250
255						22.2			20.6		22.1	18.6		20.6	16.3		19.1	14.2		10.9	8.2					255
260									19.8			17.9		19.8	15.7		18.4	13.6		10.8	7.9					260
265									19.1			17.2			15		17.7	13		10.6	7.7					265
270												16.6			14.4			12.4		10.6	7.4					270
275															13.8			11.8			7.2					275
280															13.3			11.3			7					280
285																		10.9			6.8					285
290																					6.6					290

* adapter - piece d'adaptateur

Lifting capacities

Forces de levage

TN 241

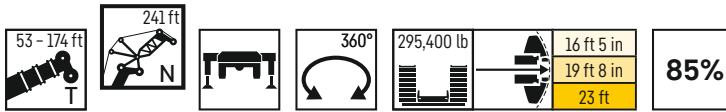

	53 ft + 13 ft*			70 ft + 13 ft*			87 ft + 13 ft*			105 ft + 13 ft*			122 ft + 13 ft*			139 ft + 13 ft*			157 ft + 13 ft*			174 ft + 13 ft*				
	83°	75°	67°	83°	75°	67°	83°	75°	67°	83°	75°	67°	83°	75°	67°	83°	75°	67°	83°	75°	67°	83°	75°			
90	39.8																							90		
95	38.6			38.8					38.8																95	
100	37.4			37.6					37.7			36.1			31										100	
105	36.3			36.5					36.6			35.4			31			23.8							105	
110	35.2			35.4					35.5			34.7			31			23.5			16.1			9.1	110	
115	34.1			34.3					34.4			33.9			30.8			23.3			15.8			8.9	115	
120	33.1			33.3					33.3			33			30.6			23			15.6			8.7	120	
125	32.1			32.3					32.4			32.2			30.3			22.8			15.4			8.5	125	
130	31.1	32.7		31.3					31.5			31.3			29.9			22.6			15.1			8.3	130	
135	30.1	31.8		30.4	32.4				30.6			30.5			29.4			22.4			14.9			8	135	
140	29.4	30.8		29.5	31.4				29.6	31.9		29.6			28.9			22.3			14.7			7.9	140	
145	28.6	30		28.8	30.6				28.9	31.1		28.8			28.4			22.1			14.5			7.7	145	
150	27.9	29.1		28.1	29.7				28.2	30.2		28.1	30.5		27.8			21.9			14.3			7.5	150	
155	27.1	28.4		27.3	28.9				27.5	29.4		27.5	29.7		27.2	28.6		21.8			14.2			7.3	155	
160	26.4	27.6		26.6	28.2				26.8	28.6		26.8	29		26.6	28.3		21.7	19.6		14			7.1	160	
165	25.8	26.9		25.9	27.5				26.1	27.9		26.2	28.2		26	27.9		21.6	19.5		13.9	12.2		7	165	
170	25.2	26.3	27.4	25.4	26.8				25.5	27.2		25.5	27.5		25.4	27.4		21.5	19.4		13.8	12.1		6.8	170	
175	24.7	25.7	26.7	24.8	26.1	27.5			24.9	26.5		25	26.9		24.9	26.9		21.4	19.2		13.6	11.9		6.6	5.3	175
180	24.1	25.1	26.1	24.3	25.6	26.8			24.4	25.9		24.4	26.2		24.4	26.4		21.3	19.1		13.5	11.8		6.5	5.2	180
185	23.6	24.5	25.5	23.8	25	26.2			23.9	25.3	26.9	24	25.6		23.9	25.8		21.3	19.1		13.4	11.6		6.3	5	185
190	23.1	24	24.9	23.2	24.4	25.6			23.4	24.8	26.2	23.5	25.1		23.4	25.2		21.3	19		13.3	11.5		6.2	4.8	190
195	22.7	23.6	24.4	22.8	23.9	25			22.9	24.3	25.6	23	24.6	26.2	23	24.7		21.3	18.9		13.3	11.4		6.1	4.7	195
200	22.3	23.1	23.9	22.4	23.4	24.5			22.5	23.7	25.1	22.5	24	25.6	22.5	24.2	22.7	21.3	18.9		13.2	11.3		6	4.5	200
205	22	22.7	23.4	22.1	23	24			22.1	23.3	24.5	22.2	23.5	25.1	22.1	23.8	22.8	21.3	18.9		13.1	11.2		5.9	4.4	205
210	21.6	22.2	23	21.7	22.5	23.5			21.8	22.9	24	21.8	23.1	24.5	21.8	23.3	22.7	21.3	18.9	16.2	13.1	11.1		5.8	4.2	210
215	21.2	21.9	22.5	21.3	22.1	23.1			21.4	22.4	23.5	21.5	22.7	24	21.5	22.8	21.9	21.2	18.9	16.2	13.1	11.1		5.7	4.1	215
220	21	21.5	22.2	21	21.8	22.6			21	22	23.1	21.1	22.3	23.4	21.1	22.5	21.1	21.1	18.9	16.2	13.1	11	8.7	5.7	4	220
225	20.7	21.2	21.8	20.7	21.4	22.2			20.8	21.7	22.7	20.8	21.9	23	20.8	22.1	20.4	21	18.9	16.2	13.1	11	8.6	5.7	3.9	225
230	20.4	20.9	21.4	20.5	21.1	21.9			20.5	21.3	22.3	20.6	21.5	22.3	20.5	21.7	19.7	20.8	18.9	16.2	13.1	10.8	8.5	5.7	3.8	230
235	20	20.7	21.1	20.3	20.8	21.5			20.3	21	21.9	20.3	21.2	21.5	20.3	21.3	19	20.7	18.9	16.2	13.1	10.5	8.4	5.7	3.7	235
240	19.2	20.4	20.9	20.1	20.6	21.2			20.1	20.7	21.5	20.1	20.9	20.6	20.1	21	18.2	20.5	18.9	15.9	13	10.5	8.3	5.7	3.7	240
245	17.3	20.2	20.6	20	20.4	20.9			20	20.5	21.2	19.9	20.6	19.9	19.9	20.8	17.5	20.3	18.9	15.2	12.7	10.4	8.1	5.7	3.6	245
250		20.2	20.4		20.2	20.6	19.4			20.3	20.9	19.8	20.4	19.1	19.8	20.5	16.8	20	18.9	14.6	12.7	10.3	7.9	5.7	3.6	250
255		19.5	20.3		20.1	20.4				20.1	20.3		20.2	18.4	19.7	20.2	16.1	20	18.8	13.9	12.5	10.2	7.7	5.7	3.6	255
260			20.2			20.3				20	19.6		20	17.7		19.7	15.4		18.2	13.3	11.4	10	7.5	5.7	3.6	260
265						20.1				20	18.9		19.9	17		19	14.8		17.5	12.7		9.9	7.2		3.6	265
270						19.8					18.2					16.4			16.9	12.2		9.7	7		3.6	270
275											17.6					15.8			16.2	11.6		9.6	6.8		3.6	275
280																15.1				11.2		9.5	6.6		3.6	280
285																14.6				10.7			6.3		3.6	285
290																				12			6.1			290
295																							5.9			295
300																							5.7			300
305																							5.6			305

* adapter - piece d'adaptateur

Lifting capacities

Forces de levage

TN 253

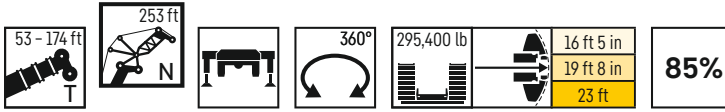

	53 ft + 13 ft*			70 ft + 13 ft*			87 ft + 13 ft*			105 ft + 13 ft*			122 ft + 13 ft*			139 ft + 13 ft*			157 ft + 13 ft*			174 ft + 13 ft*	
	83°	75°	67°	83°	75°	67°	83°	75°	67°	83°	75°	67°	83°	75°	67°	83°	75°	67°	83°	75°	67°	83°	
95	38.2			38.2																			95
100	37.1			37.2			36.3																100
105	36.1			36.2			35.6			32.8			27.9										105
110	35.1			35.3			34.8			32.6			27.9			20.3			13.3				110
115	34.2			34.3			34			32.2			27.8			20			13.1			6.6	115
120	33.2			33.4			33.2			31.6			27.7			19.8			12.9			6.4	120
125	32.3			32.4			32.4			31.1			27.5			19.5			12.6			6.2	125
130	31.5			31.6			31.5			30.6			27.4			19.3			12.4			6	130
135	30.6	32.1		30.7			30.8			30			27.2			19.1			12.2			5.8	135
140	29.7	31.1		29.9	31.6		30			29.4			27			18.8			11.9			5.6	140
145	29	30.3		29.1	30.8		29.2	31.1		28.9			26.8			18.6			11.7			5.4	145
150	28.3	29.5		28.4	30		28.5	30.4		28.3			26.6			18.4			11.5			5.2	150
155	27.7	28.8		27.8	29.3		27.9	29.6		27.7	29.1		26.4			18.2			11.3			5	155
160	27	28.1		27.1	28.5		27.2	28.9		27.1	28.6		26	24.3		18.1			11.2			4.7	160
165	26.3	27.4		26.5	27.8		26.6	28.2		26.5	28.1		25.7	24.2		17.9	16.2		11			4.6	165
170	25.7	26.8		25.9	27.2		26	27.6		26	27.6		25.3	24		17.8	16		10.8	9.4		4.4	170
175	25.2	26.2	27.2	25.3	26.6		25.4	27		25.4	27.1		25	23.9		17.6	15.9		10.7	9.2		4.2	175
180	24.7	25.7	26.6	24.8	26		24.9	26.4		24.8	26.6		24.6	23.8		17.5	15.7		10.5	9.1		4.1	180
185	24.3	25.1	26	24.4	25.5	26.6	24.4	25.8		24.4	26		24.3	23.7		17.3	15.5		10.3	8.9		3.9	185
190	23.8	24.6	25.5	23.9	25	26.1	24	25.3	26.6	24	25.5		24	23.7		17.3	15.4		10.2	8.7		3.7	190
195	23.3	24.1	25	23.4	24.5	25.5	23.5	24.8	26.1	23.6	25		23.7	23.6		17.2	15.3		10.1	8.6		3.6	195
200	22.9	23.6	24.5	23	24	25	23.1	24.3	25.5	23.1	24.5	25.4	23.4	23.5		17.2	15.2		10	8.4		3.5	200
205	22.5	23.3	24	22.6	23.5	24.5	22.6	23.8	25	22.7	24.1	24.5	23.1	23.4		17.2	15.1		9.9	8.3		3.3	205
210	22.2	22.9	23.6	22.3	23.1	24	22.3	23.4	24.6	22.3	23.6	23.7	22.7	23.3	20.7	17.1	15.1		9.8	8.1		3.2	210
215	21.9	22.5	23.2	21.9	22.8	23.6	22	23	24.1	22	23.2	23.3	22.4	23.2	20.3	17.1	15	12.8	9.7	8			215
220	21.5	22.1	22.8	21.6	22.4	23.2	21.7	22.6	23.6	21.7	22.8	22.7	22.1	23	19.6	17.1	15	12.7	9.7	7.9			220
225	21.2	21.8	22.4	21.3	22	22.8	21.3	22.2	23.2	21.4	22.4	21.9	21.8	22.8	18.9	17.1	14.9	12.6	9.7	7.8	6		225
230	21	21.5	22.1	21	21.7	22.4	21	21.9	22.8	21.1	22.1	21.2	21.5	22.6	18.6	17.1	14.9	12.6	9.7	7.7	5.9		230
235	20.8	21.2	21.7	20.8	21.4	22.1	20.8	21.6	22.4	20.8	21.7	20.5	21.2	22.3	18.5	17.1	14.9	12.5	9.7	7.7	5.7		235
240	20.6	20.9	21.4	20.6	21.1	21.8	20.6	21.3	21.9	20.6	21.4	19.8	21	21.8	17.9	17.1	14.9	12.5	9.7	7.6	5.5		240
245	19.9	20.7	21.2	20.4	20.9	21.5	20.4	21	21.1	20.4	21.2	19	20.8	21.3	17.2	17.1	14.9	12.5	9.7	7.6	5.4		245
250	18.2	20.6	20.9	19.6	20.7	21.2	20.1	20.8	20.3	20.2	20.9	18.3	20.6	20.9	16.5	17.1	14.9	12.5	9.7	7.6	5.3		250
255	16.1	20.4	20.7	18.3	20.5	20.9	19.5	20.6	19.6	19.9	20.7	17.6	20.4	20.1	15.8	17.1	14.9	12.5	9.7	7.6	5.3		255
260		19.6	20.5		20.3	20.5	18.5	20.4	18.8	19.6	20.4	16.9	20.2	19.4	15.1	17.1	14.9	12.5	9.7	7.6	5.2		260
265		18.4	20.4		20.2	19.8		20.2	18.1	18.2	19.7	16.2	20.1	18.6	14.5	17.1	14.9	11.9	9.7	7.6	5.2		265
270			20.3		19.6	19.1		20.1	17.5		19	15.6		17.9	13.9		14.9	11.4	9.3	7.6	5.2		270
275			19.9			18.4		19.6	16.8		18.3	15		17.3	13.3		14.9	11		7.5	5.2		275
280						17.7			16.2		17.7	14.4		16.6	12.7		14.8	10.6		7.4	5.1		280
285									15.6			13.8		16	12.2		14.3	10.2		7.4	5.1		285
290												13.2			11.6		13.7	9.8		7.4	5		290
295												12.7			11.2			9.4			4.8		295
300															10.8			9			4.6		300
305																		8.6			4.4		305
310																		8.3			4.2		310
315																					4.1		315

* adaptateur - piece d'adaptateur

Lifting capacities

Forces de levage

TN 264

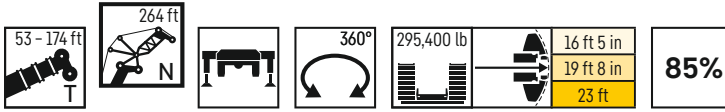

	53 ft + 13 ft*			70 ft + 13 ft*			87 ft + 13 ft*			105 ft + 13 ft*			122 ft + 13 ft*			139 ft + 13 ft*			157 ft + 13 ft*			174 ft + 13 ft*			
	83°	75°	67°	83°	75°	67°	83°	75°	67°	83°	75°	67°	83°	75°	67°	83°	75°	67°	83°	75°	67°	83°			
100	34.2			33.6																			100		
105	33.3			32.9			31.6						29.1											105	
110	32.5			32.2			31						28.8			24.6			17.2					110	
115	31.7			31.4			30.4						28.5			24.4			16.9			10.6		115	
120	30.8			30.7			29.9						28.1			24.1			16.7			10.4		120	
125	30			30			29.3						27.6			23.8			16.4			10.1		125	
130	29.3			29.3			28.7						27.2			23.5			16.2			9.9		130	
135	28.6			28.6			28.2						26.8			23.3			15.9			9.7		135	
140	27.9	29		28			27.6						26.3			23			15.7			9.4		140	
145	27.2	28.3		27.3	28.6		27.1						25.9			22.8			15.5			9.2		145	
150	26.6	27.7		26.6	28		26.6	27.5					25.5			22.6			15.3			9		150	
155	26	27		26.1	27.4		26	27					25.1			22.4			15			8.8		155	
160	25.5	26.4		25.6	26.8		25.5	26.6					24.7	25.5		22.1			14.8			8.6		160	
165	25	25.8		25	26.2		25.1	26.1					24.3	25.1		22	20.2		14.6			8.4		165	
170	24.4	25.3		24.5	25.6		24.6	25.6					23.9	24.7		21.8	20.1		14.4	13		8.2		170	
175	23.9	24.8		24	25.1		24.1	25.2					23.5	24.4		21.7	19.9		14.2	12.8		8	6.8	175	
180	23.5	24.3	25.1	23.5	24.6		23.6	24.7					23.2	24		21.5	19.7		14.1	12.6		7.8	6.6	180	
185	23.1	23.8	24.6	23.1	24.1		23.1	24.3					22.8	23.7		21.3	19.5		13.9	12.4		7.6	6.4	185	
190	22.7	23.4	24.1	22.7	23.7	24.6	22.8	23.8					22.4	23.3		21.2	19.4		13.7	12.2		7.4	6.2	190	
195	22.3	23	23.7	22.4	23.3	24.1	22.4	23.4					22.2	23		21	19.3		13.6	12.1		7.3	6	195	
200	21.9	22.6	23.2	22	22.9	23.7	22	23	23.8				21.9	22.6		20.8	19.2		13.5	11.9		7.1	5.8	200	
205	21.5	22.2	22.9	21.6	22.4	23.3	21.7	22.7	23.5				21.6	22.3	22.9	20.6	19.1		13.4	11.8		7	5.7	205	
210	21.3	21.9	22.5	21.3	22	22.9	21.3	22.3	23.1				21.3	22	22.6	20.5	19		13.3	11.6		6.9	5.5	210	
215	21	21.5	22.1	21	21.7	22.5	21	21.9	22.8				20.9	21.7	21.9	20.3	19	16.6	13.2	11.6		6.8	5.4	215	
220	20.7	21.2	21.8	20.8	21.4	22.1	20.8	21.6	22.4				20.7	21.4	21.2	20.1	18.9	16.4	13.1	11.5	9.5	6.6	5.2	220	
225	20.5	20.9	21.5	20.5	21.1	21.8	20.5	21.3	22.1				20.5	21.2	20.4	19.9	18.9	16.4	13.1	11.4	9.4	6.5	5.1	225	
230	20.2	20.6	21.1	20.2	20.8	21.5	20.3	21	21.7				20.2	20.9	19.7	19.8	18.9	16.4	13.1	11.3	9.3	6.5	5	230	
235	20	20.4	20.9	20	20.5	21.2	20	20.7	21.4				20	20.7	19.1	19.6	18.9	16.4	13.1	11.2	9.2	6.5	4.9	3.4	235
240	19.8	20.2	20.6	19.8	20.3	20.9	19.8	20.4	20.9				19.8	20.5	18.6	19.4	18.9	16.1	13.1	11.2	9.1	6.4	4.7	3.2	240
245	19.6	20	20.4	19.7	20.1	20.6	19.6	20.2	20.4				19.6	20.2	18.6	19.2	18.9	15.6	13.1	11.2	9	6.4	4.6		245
250	19.4	19.8	20.1	19.5	19.9	20.4	19.5	20	19.8				19.4	20	18.3	19.1	18.9	15	13.1	11.2	9	6.4	4.6		250
255	18.9	19.7	20	19.4	19.7	20.1	19.4	19.8	19				19.3	19.8	17.6	19	18.9	14.5	13.1	11.2	8.9	6.4	4.6		255
260	17	19.6	19.8	18.6	19.6	19.9	19.1	19.6	18.3				19.2	19.6	16.9	18.9	18.3	14.5	13.1	11.2	8.9	6.4	4.5		260
265	14.8	19.4	19.6	17	19.5	19.3	18.3	19.5	17.6				18.9	19.2	16.2	18.8	17.6	14	13.1	11.2	8.9	6.4	4.5		265
270		18.6	19.5	14.8	19.4	18.6	17	19.4	17				18.1	19	15.5	18.7	16.9	13.4	13.1	11.2	8.9	6.4	4.5		270
275		17.1	19.3		18.9	17.9		19.1	16.3				17.4	18.3	14.9	18.4	16.8	12.8	13.1	11.2	8.9	6.4	4.5		275
280			18.7		18	17.3		18.5	15.7					17.6	14.3		16.2	12.2	13.1	11.2	8.9	6.4	4.5		280
285			18			16.6		17.8	15.1					16.9	13.7		15.6	11.7		11.2	8.9		4.5		285
290						16			14.5					16.3	13.1		15	11.2		11.2	8.9		4.5		290
295									13.9						12.6		14.4	10.8		11.2	8.9		4.5		295
300									13.4						12.1			10.4		11.2	8.6		4.5		300
305															11.5			10			8.3		4.5		305
310																		9.6			7.9				310
315																					7.6				315
320																					7.2				320

* adapter - piece d'adaptateur

Lifting capacities

Forces de levage

TN 276

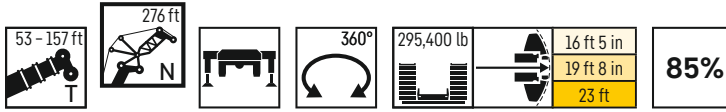

	53 ft + 13 ft*			70 ft + 13 ft*			87 ft + 13 ft*			105 ft + 13 ft*			122 ft + 13 ft*			139 ft + 13 ft*			157 ft + 13 ft*			
	83°	75°	67°	83°	75°	67°	83°	75°	67°	83°	75°	67°	83°	75°	67°	83°	75°	67°	83°	75°		
100	32.1																				100	
105	31.5			30.8			29.5															105
110	30.9			30.2			29			26.1			21.2									110
115	30.2			29.6			28.5			26.1			21			14.2						115
120	29.6			29			28			25.9			20.7			13.9			8			120
125	28.9			28.5			27.5			25.7			20.4			13.6			7.7			125
130	28.3			27.9			27			25.4			20.1			13.4			7.5			130
135	27.7			27.3			26.5			25.1			19.8			13.1			7.3			135
140	27.2			26.8			26.1			24.7			19.5			12.8			7			140
145	26.6	27.3		26.3			25.6			24.4			19.2			12.6			6.8			145
150	26	26.8		25.8	26.5		25.2			24.1			19			12.3			6.6			150
155	25.5	26.2		25.3	26.1		24.7	25.5		23.7			18.7			12.1			6.4			155
160	25.1	25.7		24.8	25.6		24.3	25.1		23.4			18.5			11.9			6.2			160
165	24.6	25.2		24.4	25.1		23.9	24.7		23	22.3		18.2			11.6			5.9			165
170	24.2	24.8		24	24.7		23.5	24.3		22.7	22.1		18	16.6		11.4			5.7			170
175	23.7	24.3		23.6	24.3		23.2	23.9		22.4	21.9		17.8	16.4		11.2	10		5.5			175
180	23.2	23.9		23.2	23.9		22.8	23.5		22.1	21.7		17.6	16.2		11	9.8		5.3	4.2		180
185	22.8	23.5		22.8	23.5		22.4	23.2		21.8	21.5		17.3	15.9		10.8	9.5		5.1	4		185
190	22.5	23.1	23.6	22.4	23.1		22	22.8		21.5	21.3		17.1	15.7		10.6	9.4		4.9	3.8		190
195	22.1	22.7	23.2	22.1	22.7	23.2	21.7	22.5		21.2	21.1		16.9	15.5		10.4	9.2		4.7	3.7		195
200	21.8	22.4	22.8	21.7	22.4	22.9	21.5	22.1		21	20.9		16.7	15.4		10.2	9		4.5	3.5		200
205	21.5	22	22.5	21.4	22	22.6	21.2	21.8	22.3	20.8	20.8		16.6	15.2		10.1	8.8		4.4	3.3		205
210	21.1	21.7	22.1	21.1	21.7	22.2	20.9	21.5	22	20.5	20.6	18.6	16.5	15		9.9	8.6		4.2	3.1		210
215	20.8	21.4	21.8	20.8	21.4	21.9	20.6	21.2	21.7	20.3	20.5	18.4	16.4	14.9		9.8	8.5		4			215
220	20.6	21.1	21.5	20.5	21.1	21.6	20.3	21	21.4	20	20.4	18.3	16.2	14.8	12.9	9.6	8.3		3.9			220
225	20.3	20.8	21.2	20.3	20.8	21.3	20.1	20.7	21.2	19.8	20.3	18.2	16.1	14.6	12.7	9.5	8.2		3.7			225
230	20.1	20.6	20.9	20.1	20.6	21	19.9	20.4	20.8	19.6	20.1	18.1	16.1	14.5	12.6	9.3	8.1	6.4	3.6			230
235	19.9	20.3	20.7	19.9	20.3	20.8	19.7	20.2	20.4	19.5	20	18.1	16.1	14.4	12.4	9.3	7.9	6.3	3.5			235
240	19.7	20.1	20.4	19.7	20.1	20.5	19.5	20	19.7	19.3	19.8	17.9	16.1	14.3	12.4	9.3	7.8	6.2	3.4			240
245	19.3	19.9	20.2	19.5	19.9	20.3	19.3	19.8	19.1	19.1	19.6	17.3	16.1	14.3	12.3	9.2	7.7	6	3.3			245
250	18.7	19.7	20	19.2	19.7	20	19.1	19.6	18.7	18.9	19.4	16.7	16.1	14.3	12.2	9.2	7.6	5.9	3.2			250
255	18.1	19.5	19.8	18.9	19.5	19.8	19.1	19.4	18.6	18.8	19.2	16.1	16.1	14.3	12.1	9.2	7.5	5.8	3.2			255
260	17.5	19.4	19.6	18.6	19.4	19.3	19	19.3	18	18.7	19.1	15.5	16.1	14.3	12.1	9.2	7.4	5.7	3.1			260
265	16.9	19.2	19.5	18.4	19.2	18.5	18.9	19.1	17.3	18.7	18.6	14.9	16.1	14.3	12.1	9.2	7.4	5.6				265
270	15.1	19.1	19.3	17.7	19.1	17.8	18.7	18.9	16.6	18.6	17.9	14.2	16.1	14.3	11.7	9.2	7.3	5.5				270
275	13.2	19	18.7	15.6	19.1	17.2	17.6	18.7	16	18.3	17.3	14.1	16.1	14.3	11.3	9.2	7.3	5.5				275
280	10.6	18	18	13.4	18.8	16.5	16.1	18.1	15.4	17.2	16.6	13.6	16.1	14.3	10.8	9.2	7.3	5.5				280
285		15.6	17.3		18.2	15.9	13.7	17.5	14.7	15.9	16.2	13	16.1	14.3	10.5	9.2	7.3	5.4				285
290			16.7		16.6	15.3		16.8	14.2		15.7	12.4	15.3	13.7	10.5	9.2	7.3	5.4				290
295			16.1		14.1	14.7		16.2	13.6		15	11.9		13.1	10.2		7.3	5.4				295
300						14.2			13		14.4	11.4		12.6	9.8		7.3	5.4				300
305						13.6			12.5			11		12.5	9.5		7.3	5.4				305
310									11.9			10.6			9.1		7.3	5.4				310
315												10.2			8.7			5.4				315
320															8.4			5.4				320
325															8			5.4				325
330																		5.4				330

* adapter - piece d'adaptateur

Equipment

Crane carrier

Frame	Self-manufactured, torsion-resistant box-type design of high-tensile fine grained structural steel.
Outriggers	4-point supporting system, hydraulically telescopic into horizontal and vertical direction. Operation with remote control, automatic support leveling, electronic inclination display.
Engine	8-cylinder Diesel, make Liebherr, watercooled, output 505 kW (686 h.p.), max. torque 2263 lb-ft. Exhaust emissions acc. to (EU) 2016/1628, EPA/CARB or ECE-R.96. Fuel reservoir: 225 gallons.
Transmission	Automatic transmission system with torque converter and interarder, make ZF, 12 forward speeds and 2 reverse speeds, transfer case with transfer differential.
Axles	Low maintenance crane chassis axles, all 8 axles steered. Axles 1, 2, 4 and 5 are planetary axles. Axles 4 and 5 with transversal differential locks, axles 2 and 4 with longitudinal differential locks.
Suspension	All axles are mounted on hydropneumatic suspension – “Niveaumatik suspension” and are lockable hydraulically.
Tyres	16 tyres. Size of tyres: 445/95 R 25 (16.00 R 25).
Steering	2-circuit system with hydraulic servo steering. Active speed depending rear axle steering, special steering programs for various driving situations.
Brakes	Service brake: all-wheel servo-air brake, all axles are equipped with disc brakes, dual circuit. Additional brakes: exhaust flap brake, Telma Eddy current brake, interarder in gearbox. Hand brake: Spring-loaded, acting on all wheels of axles 3 to 7.
Driver's cab	Spacious corrosion resistant with comfort furnishings, mounted on rubber shock absorbers, safety glazing.
Electrical system	Modern data bus technique, 24 Volt DC.

Crane superstructure

Frame	Liebherr-manufactured, torsionally rigid steel construction made from high-tensile fine-grain steel. Triple-roller slewing rim.
Crane drive	Mechanical drive of the crane hydraulic from the chassis. Variable axial piston pumps with servo control and power regulation.
Control	Two self-centering control levers (joy-sticks). Pedal switches for telescoping. Infinitely variable crane motions through displacement control of the hydraulic pumps. Additional working speed control by variation of the Diesel engine speed.
Hoist gear	Axial piston variable displacement motor, hoist drum with integrated planetary gear and spring-loaded static brake. Actuation by closed regulated oil circuit.
Luffing gear	2 differential rams with pilot-controlled brake valve.
Slewing gear	2 axial piston constant motors, planetary gear, spring loaded multiple disk brake. Actuation by closed regulated oil circuit.
Crane cab	Large screen area, compound glass, comfort furnishing, cabin tiltable approx. 20° to rear.
Safety devices	LICCON2 safe load indicator, test system, hoist limit switches, safety valves against rupture of pipes and hoses.
Telescopic boom	1 base section and 6 telescopic sections. All telescopic sections extendable individually by means of the rapid-cycle telescoping system TELEMATIK. Boom length 53 ft to 279 ft.
Counterweight	295,400 lb, hydraulic ballasting device.

Additional equipment

K	Swing away jib 23 ft – 115 ft Adjustment 0°; 10°; 20°; 40°
F	Fixed lattice jib 23 ft – 184 ft Adjustment 0°; 10°; 20°; 40°
N	Luffing fly jib 46 ft – 276 ft
H	Auxiliary jib 5 ft
2nd hoist gear	For the 2hook operation or as luffing winch.
Tyres	16 tyres, size 525/80 R 25 (20.5 R 25).

Other items of equipment available on request.

Équipement

Châssis porteur

Cadre	Châssis résistant à la torsion de fabrication Liebherr, en acier à grains fins très résistant.
Calage	Dispositif de calage horizontal et vertical en 4 points, entièrement déployable hydrauliquement. Utilisation avec commande à distance, mise à niveau automatique du calage, inclinomètre électronique.
Moteur	Moteur diesel, 8 cylindres, fabriqué par Liebherr, à refroidissement par eau, de 505 kW (686 ch), couple max. 2263 lb-ft. Emissions des gaz d'échappement conformes au directive (EU) 2016/1628, EPA/CARB ou ECE-R.96. Capacité du réservoir à carburant: 225 gallons.
Boîte de vitesse	Boîte automatique avec convertisseur de couple et ralentisseur, marque ZF, 12 marches AV et 2 marches AR, boîte de transfert avec différentiel répartiteur.
Essieux	Grues automotrices à faible entretien, 8 essieux directeurs. Essieux 1, 2, 4 et 5 planétaires. Essieux 4 et 5 avec blocages de différentiels transversaux, essieux 2 et 4 avec blocages de différentiels longitudinaux.
Suspension	Suspension hydropneumatique «Niveumatik» - sur tous les essieux. Chaque essieu peut être bloqué hydrauliquement.
Pneumatiques	16 pneus. Taille: 445/95 R 25 (16.00 R 25).
Direction	2 circuits avec direction assistée hydraulique. Direction active des essieux arrière et dépendante de la vitesse, programmes de direction spéciaux pour les différents modes de déplacement.
Freins	Freins de service : servofrein à air comprimé, tous les essieux sont munis de freins à disque, à 2 circuits. Freins auxiliaire : par clapet sur échappement, frein Telma, ralentisseur monté sur boîte de vitesse. Frein de secours et frein à main : par cylindres à ressorts sur les essieux 3 à 7.
Cabine	Spacieuse cabine, traitement anticorrosion, équipement «grand confort», suspension par silentbloks, vitrage de sécurité.
Installation électrique	Technique moderne de transmission de données par BUS de données, courant continu 24 Volts.

Partie tournante

Cadre	Fabrication Liebherr, construction soudée indéformable, en acier à grain fin haute résistance. Couronne d'orientation à triple rangée de rouleaux.
Entraînement	Entraînement mécanique de l'hydraulique de la grue par le châssis de la grue. Pompes réglables à pistons axiaux avec servocommande et réglage de puissance.
Commande	2 leviers à 4 directions avec rappel automatique au point mort. Commande des mouvements progressive en continu par variation de l'inclinaison des pompes et augmentation du régime moteur.
Mécanisme de levage	Moteur hydraulique à cylindrée variable, treuil avec réducteur planétaire à frein d'arrêt à lamelles intégrées, en circuit hydraulique ferme.
Mécanisme de relevage	2 vérin différentiel avec clapet de frein commandé.
Dispositif de rotation	2 moteur à débit constant et pistons axiaux, réducteur planétaire, frein d'arrêt à ressort commandé par ressort en circuit hydraulique ferme.
Cabine de grue	Large champ de vision, vitrage de sécurité, équipement pour un confort idéal, cabine inclinable de env. 20° vers l'arrière.
Dispositif de sécurité	Contrôleur de charge LICCON2, système test, fin de course crochet haut, clapets de sécurité en cas de ruptures de flexibles.
Flèche télescopique	Un élément de base et de 6 télescopes. Chaque partie peut être télescopée individuellement à l'aide du système de télescopage séquentiel rapide TELEMATIK. Longueur de flèche: 53 ft - 279 ft.
Contrepoids	295,400 lb, dispositif de lestage hydraulique.

Équipement supplémentaire

K	Flechette pliante 23 ft - 115 ft Positionnement 0°; 10°; 20°; 40°
F	Flechette treillis fixe 23 ft - 184 ft Positionnement 0°; 10°; 20°; 40°
N	Fléchette treillis à volée variable 46 ft - 276 ft
H	Fléchette auxiliaire 5 ft
2ème mécanisme de levage	Pour le mode double crochet ou comme treuil de manœuvre de la volée.
Pneumatiques	16 pneus. Taille: 525/80 R 25 (20.5 R 25).

Autres équipements supplémentaires sur demande.

Description of symbols

Explication des symboles



Max. capacity
Capacité max.



Outriggers rear
Calage arrière



Telescopic boom
Flèche télescopique



Max. hoist height
Hauteur de levage max.



Crane superstructure
Partie tournante de la grue



Swing away jib
Fléchette pliante



Max. radius
Portée max.



infinitely variable
en continu



Fixed lattice jib
Fléchette treillis fixe



Tyres
Pneumatiques



Rope diameter
Diamètre



Luffing fly jib
Fléchette treillis à volée variable



Hookblock/Capacity
Moufle à crochet/Capacité de charge



Rope length
Longueur du câble



No. of sheaves
Poulies



Max. single line pull
Effort au brin maxi.



No. of lines
Brins



Hoist gear
Treuil de levage



Weight
Poids



Slewing speeds
Vitesses d'orientation



Crane carrier
Châssis porteur



Boom length
Longueur de la flèche



Driving speed
Vitesse de translation



Boom position
Position de la flèche



Gradability
Aptitude à gravir les pentes



Counterweight
Contrepoids



Transmission
Boîte de vitesse



Counterweight radius
Rayon de contrepoids



Gear
Vitesse



Outriggers
Calage



Onroad gear
Vitesse de route



Slewing gear / Working area
Mécanisme d'orientation / Plage de travail



Max. supporting forces
Forces d'appui max.



Standard
Norme



Outriggers front
Calage avant



Radius
Portée

Remarks

1. The lifting capacities do not exceed 85 % of the tipping load according to ASME B 30.5. The crane's structural steelwork is in accordance with EN 13000 and ASME B 30.5.
2. For the calculation of the load charts at least a wind speed of 30 ft/s (9 m/s, 20 mph) and regarding the load a sail area of 1 m² per ton load and a wind resistance coefficient of 1.2 on the load have been taken into account. For lifting of loads with large sail areas and/or high wind resistance coefficients the maximum wind speed as stated in the load charts has to be reduced.
3. The lifting capacities stated are valid for lifting operation only (corresponding with crane classification according to ISO 4301-1, crane group A1).
4. Lifting capacities are given in kip.
5. The weight of the hook blocks and hooks is part of the load and therefore it must be deducted from the lifting capacities.
6. Working radii are measured from the slewing centre.
7. The stated lengths of the telescopic boom are maximum values and may deviate slightly.
8. The lifting capacities given for the telescopic boom apply if the folding jib is removed.
9. Subject to modification of lifting capacities.
10. Lifting capacities above 444,200 lb/527,600 lb only with additional pulley block/special equipment.
11. The data of this brochure serves only for general information. All information is provided without warranty. Instructions for the correct commissioning of the crane please take from the operation manual and the load chart book.
12. The illustrations in this brochure may feature accessories and special equipment not included in the standard scope of delivery.

Remarques

1. La capacité de charge ne doit pas dépasser 85 % de la charge de basculement conformément à ASME B 30.5. La structure métallique de la grue est conforme à EN 13000 et ASME B 30.5.
2. Une vitesse de vent de 30 ft/s (9 m/s, 20 mph) minimum, une surface de prise au vent de 1 m² par tonne ainsi qu'un coefficient de résistance au vent de la charge 1,2 sont pris en compte pour le calcul des tableaux de charge. Lorsque des charges ayant une surface de prise au vent et/ou un coefficient de résistance au vent plus élevé(e)s sont levées, la vitesse de vent maximale indiquée dans les tableaux de charge doit être réduite.
3. Forces de levage pour application de grue de montage (correspond à la classification de grues selon ISO 4301-1, groupe de grues A1).
4. Les charges sont indiquées en kip.
5. Le poids du crochet de levage resp. de la moufle à crochet est une partie de la charge et doit donc être déduit de la capacité de charge.
6. Les portées sont calculées à partir de l'axe de rotation.
7. Les longueurs indiquées pour la flèche télescopique sont des valeurs maximales et peuvent légèrement varier dans la réalité.
8. Les charges indiquées pour la flèche télescopique sont valables lorsque la fléchette pliante est démontée.
9. Charges données sous réserve de modification.
10. Forces de levage plus de 444,200 lb/527,600 lb seulement avec moufle additionnel/equipement supplémentaire.
11. Les données de cette brochure sont données à titre informatif. Ces renseignements sont sans garantie. Les consignes relatives à la bonne mise en service de la grue sont disponibles dans le manuel d'utilisation et le manuel de tableaux de charge.
12. Les figures contiennent également des accessoires et des équipements spéciaux non inclus de série dans la livraison.

MyLiebherr

Our MyLiebherr portal is the easy way for you to access Liebherr's digital service world.
Take advantage of extensive basic and additional services for your mobile and crawler cranes.

Avec notre portail MyLiebherr, accédez facilement à l'univers numérique du service de Liebherr.
Bénéficiez dès maintenant d'un service global et de prestations complémentaires pour vos grues mobiles et sur chenilles.



One portal, all services

MyLiebherr



Planning

Crane Finder



Operations

Performance



Planning

Crane Planner 2.0



Operations

Documents



Maintenance

Spare Parts Catalogue



Planning

LICCON Work Planner



Training

Digital Crane Operator



Maintenance

Parts Shop

Proposition 65



WARNING: This product can expose you to chemicals, including exhaust emissions, including lead and lead compounds, which are known to the State of California to cause cancer, birth defects or other reproductive harm.
For more information see: www.P65warnings.ca.gov/diesel

Subject to modification · Sous réserve de modifications

Liebherr-Werk Ehingen GmbH · Postfach 1361 · 89582 Ehingen, Germany
Phone +49 73 91 5 02-0 · www.liebherr.com

MyLiebherr



Printed in Germany (2)
lwe-ta-268-05-us11-2024