



# AUSTEK FULL INVERTER SWIMMING POOL HEAT PUMP

Installation and Instruction Manual



Please read this manual carefully before installation, operation or maintenance.

# CONTENTS

1. PRECAUTIONS	1
1.1. Risks of Casualties	2
1.2. Risks of Equipment Damage	2
1.3. Attention	3
2. GENERAL INFORMATION	4
2.1. Accessories	4
2.2. Working Mode	4
2.3. Technical Specification	5
2.4. Unit Dimension	6
3. INSTALLATION INSTRUCTION	7
3.1. Transportation	7
3.2. Installation Distance	7
3.3. Installation of Drain Pipe	8

3.4. Installation of Water Union	8
3.5. Installation of Water Pipe	8
3.6. Layout of Water System	9
3.7. Electric Installation	9
4. TESTING	11
4.1. Initial Inspection	11
4.2. Leakage Detection	11
4.3. Trial Operation	11
5. OPERATION	12
5.1. Overview of Wire Controller	12
5.2. Operation of Wire Controller	14
5.3. Connection and Operation of APP	20
6. MAINTENANCE	31
6.1. Cleaning	31
6.2. Inspection	31

6.3. Winterizing

.....

.... 31









6.4. Warranty

.....

..... 32

# 1. PRECAUTIONS

The following are special precautions that need to be followed strictly.

 R32 Gas	<p>The refrigerant used in this equipment is flammable. Exposure of refrigerant to external ignition sources may cause a fire hazard. This equipment needs to be kept away from any source of fire.</p>
	<p>Read this manual carefully before performing any operation of the equipment.</p>
	<p>The installation and maintenance of this equipment must be performed by professional service personnel.</p>
	<p>Service personnel should strictly refer to this manual when installing, operating or maintaining the equipment.</p>
	<p>Before installing the equipment, the power supply, voltage, and frequency must be confirmed to be correct. Connect the power cord correctly according to the wiring diagram on the device.</p>
	<p>The equipment must be properly grounded to prevent the risk of electric shock due to leakage of electricity.</p>
	<p>The equipment must be vacuumed thoroughly before welding. Welding should only be done by professional service personnel.</p>
	<p>The equipment must be placed in a well-ventilated area. Indoors or in enclosed areas is not allowed.</p>

---

## 1.1. Risks of Casualties

- a. It is strictly prohibited to store flammable, explosive and toxic items in the place where the unit is used to prevent accidents such as fires and explosions.
- b. Improper installation may cause fire or electric shock.
- c. Improper operation may result in personal injury.
- d. Please place the main power switch out of the reach of children and avoid contact by children.
- e. This equipment is not suitable for direct use by children. Children must be supervised by adults when using it to ensure their safety.
- f. If this product needs to be operated at high temperatures, appropriate fire extinguishing devices should be prepared, such as dry powder or carbon dioxide fire extinguishers.
- g. Do not touch the edges of fins to avoid cuts.
- h. Do not operate or touch this equipment with wet hands to prevent electric shock.
- i. Do not put your fingers into the vents, as high-speed fan operation may cause serious injury.
- j. Do not touch the refrigerant pipe with your hands to avoid burns.
- k. When it is necessary to cut off the power for maintenance, please wait for 1 minute after the power is cut off before touching the circuit board to avoid electric shock caused by capacitor discharge.
- l. If refrigerant leakage occurs during installation or use, any operation should be stopped immediately and service personnel should be asked to check.
- m. Do not clean the machine while the power is on. Please turn off the power before cleaning.  
Otherwise, personal injury or electric shock may occur due to the fan operating at high speed.

## 1.2. Risks of Equipment Damage

- a. The equipment must be stored and transported vertically in its original packaging. If this is not possible, do not operate immediately after correct placement and must wait at least 24 hours before applying power.
- b. Ensure that the water flow has been established before starting the equipment. Do not start the device until water flow is established. Otherwise, there is a risk of damage to the device.
- c. In winter or when the air temperature is below 0°C, the water must be drained when the equipment is not in use. Otherwise, the equipment will be damaged by freezing. In this case your warranty will be void.
- d. Improper installation may cause the equipment to fall or leak.
- e. Misoperation may cause damage to the equipment.
- f. Do not place objects that obstruct airflow near the air inlet and outlet. Otherwise, it will affect the efficiency of the equipment and even cause the equipment to malfunction and stop running.
- g. Please turn off the main power supply during thunderstorms to avoid equipment damage or short circuit.

- 
- h. Make sure that no water penetrates into the electrical components, otherwise the electrical components will be damaged.
  - i. Do not use any method to accelerate the defrosting process or clean frosted parts, otherwise the equipment may be damaged.

### 1.3. Attention

- a. Install this equipment in accordance with local laws, regulations and standards.
- b. After receiving the product, carefully inspect it and confirm whether it is in good condition, whether there are fixing screws, and whether the accessories are complete.
- c. Before formal installation, unpack the heat pump, cut off the packaging tape, remove the packaging, and take out the bottom wooden pallet. Plastic bags and tape should be disposed of properly and kept out of the reach of children.
- d. Ensure that the equipment is installed securely.
- e. A circuit breaker must be installed between the equipment and the user's power supply.
- f. Check the surrounding environment of the cable to ensure that it is not affected by wear, corrosion, extrusion, sharp edges or any other adverse environment. The cables need to be connected firmly to avoid loosening due to continuous vibration of the compressor, fan, etc.
- g. If leakage is found in the pipe connected to the water inlet and outlet, the equipment needs to be shut down immediately.
- h. In order to optimize the heating effect, install insulation materials on the water pipes.
- i. Set the appropriate temperature for a comfortable experience, too heat or too cold should be avoided.
- j. The pool insulation cover can be used during the heat pump heating process, which will help improve the heating efficiency of the heat pump.
- k. When the equipment fails to operate normally or reports a fault code, stop operation and contact maintenance personnel.
- l. Use only parts specified by the manufacturer to replace components.

## 2. GENERAL INFORMATION

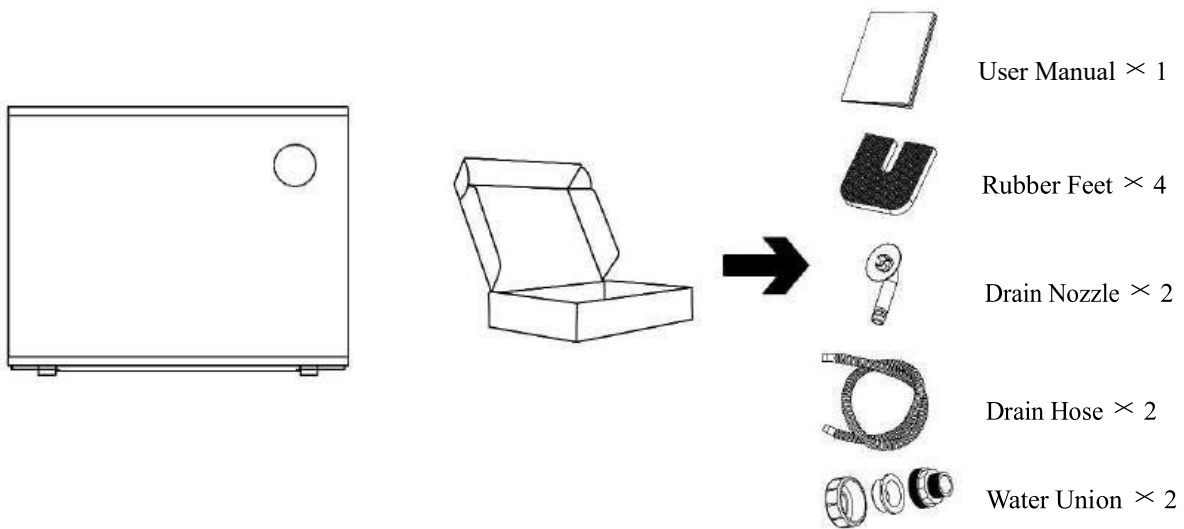

## 2.1. Accessories

After unpacking the unit, please open the accessory box and then check if you have all of the following accessories.



## 2.2. Working Mode

In order to realize a better user experience, the heat pump is equipped with three working modes – Boost, Smart and Silence. For every mode, the machine’s frequency can be automatically adjusted based on the air temperature and water temperature. To better understand these three modes, please check the following advantages of them.

Mode		Advantage
	Boost	Maximize the performance of the heat pump and realize rapid heating or cooling.
	Smart	This mode can be used if rapid heating or cooling is not required, achieving more energy-saving effect.

	Silence	Achieve a silent state of the heat pump, with the best energy saving effect, while also maintaining water temperature.
--	---------	--

## 2.3. Technical Specification

Model No.	Austek thermomax	22kw	26kw	32kw
Refrigerant	/	R32		
Power Supply	/	220-240V~/50Hz		
Performance Condition: Air Temperature 27°C, Inlet Water Temperature 26°C, Humidity 80%				
Heating Capacity	kW	22.09	26.03	32.21
COP	W/W	22.14~7.24	22.04~7.44	22.09~7.25
Performance Condition: Air Temperature 15°C, Inlet Water Temperature 26°C, Humidity 70%				
Heating Capacity	kW	15.05	17.90	22.51
COP	W/W	8.78~5.64	8.91~5.61	8.70~5.59
Operating Air Temperature	°C	-20~43		
Rated Power Input at 15°C	kW	0.41~2.67	0.45~3.19	0.57~4.03
Compressor	/	Mitsubishi		
Sound Level (1m)	dB(A)	38.1-47.1	38.9~47.8	39.7~48.6
Sound Level (10m)	dB(A)	18.1-27.1	18.9~27.8	19.7~28.6
Max. Current	A	18.5	20.5	28.0
Advised Water Flow	m <sup>3</sup> /h	9.5	11.0	14.0
Water Pressure Drop	kPa	35	35	40
Water Connection	mm	48.3		

---

## 2.4. Unit Dimension

unit: mm

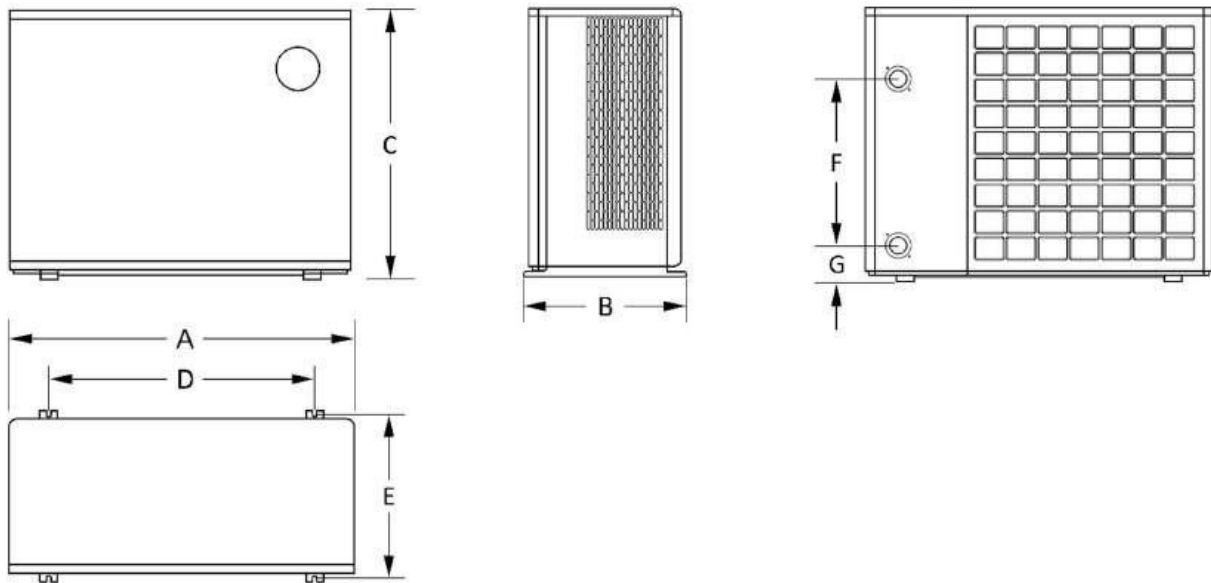

Model	A	B	C	D	E	F	G
22kw	1115	510	815	870	485	520	100
26kw	1165	555	965	910	530	620	100
32kw	1195	585	1415	880	560	350	110

### 3. INSTALLATION INSTRUCTION

#### 3.1. Transportation

- a. When storing or moving the heat pump, always keep it upright and never place it on its side.

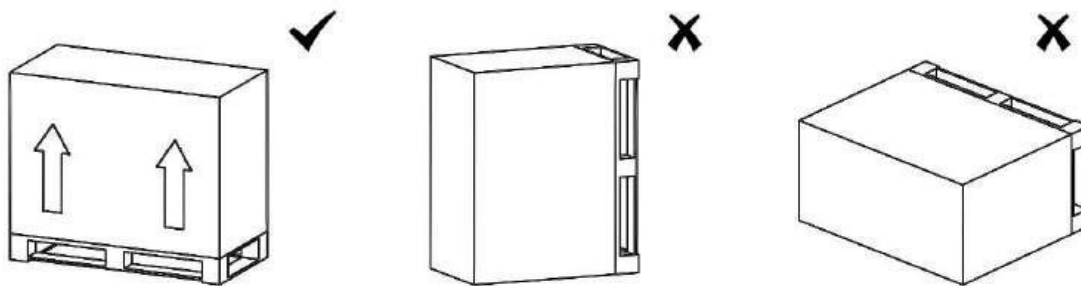

b.

When you need to move the heat pump, do not lift the water pipe joint, otherwise the internal titanium heat exchanger will be damaged.

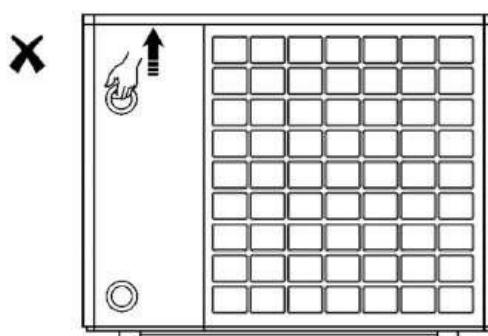

### 3.2. Installation Distance

The heat pump should be installed in a well-ventilated area. And the location of the unit must be easily accessible for convenient operation and maintenance. It should be installed in the place greater than the following distances:

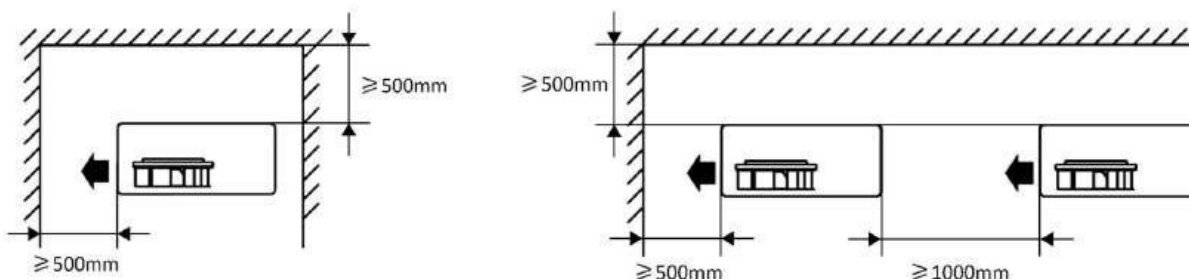

### 3.3. Installation of Drain Pipe

The drain pipe needs to be installed to the corresponding drain port on the bottom of the heat pump as follows.

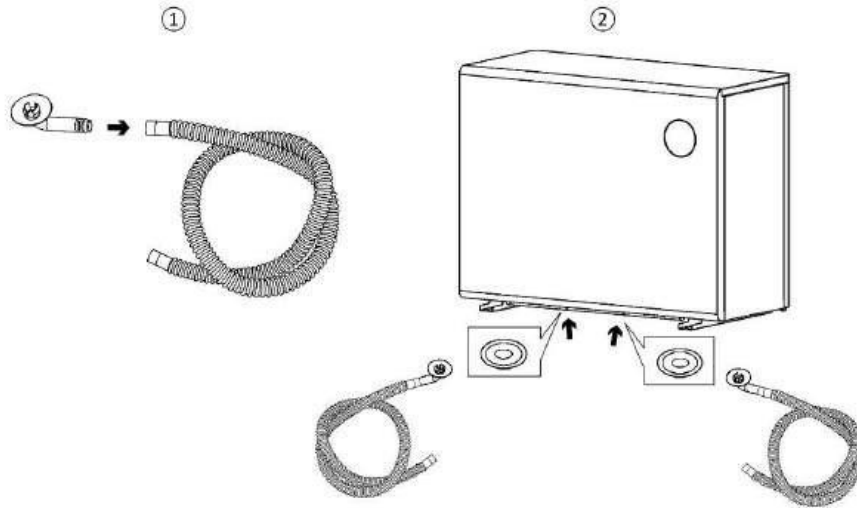

### 3.4. Installation of Water Union

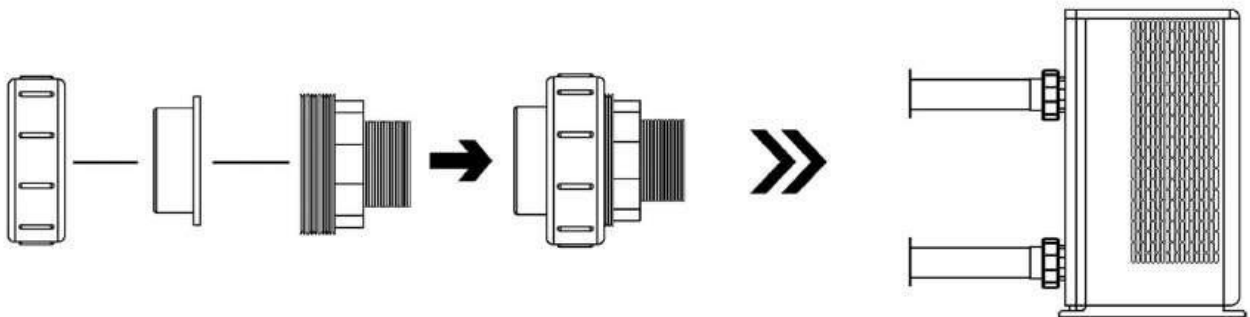

### 3.5. Installation of Water Pipe

When connecting water pipes, use hard pipes rather than flexible hoses, as hoses will increase the resistance of the pipes.

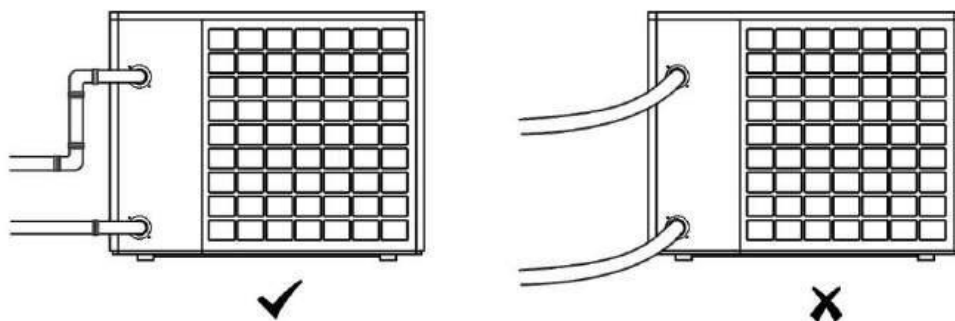

### 3.6. Layout of Water System

Keep the water pump running if operating temperature drops below 0°C. To keep the water in your system clean and avoid filter clogging, the filter must be cleaned regularly.

The suggested installation schematic of water system is shown below:

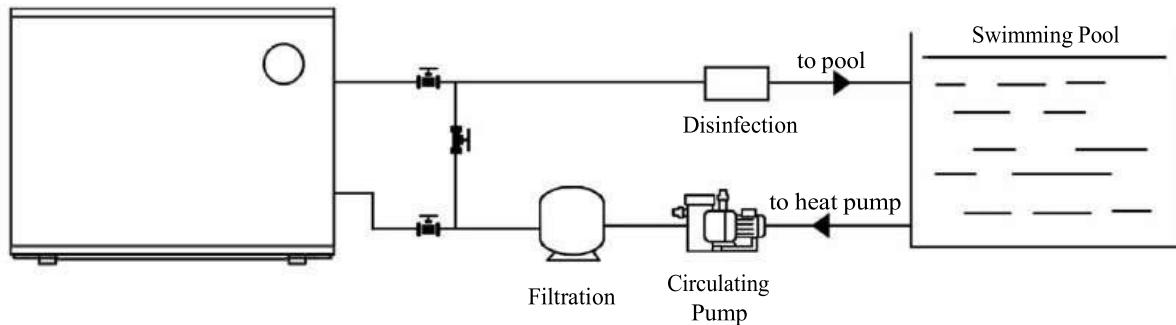

### 3.7. Electric Installation

#### (1) Wiring Precautions

For safe operation and to maintain the integrity of the electrical system, wiring must be conducted in accordance with the following regulations:

- a. Wiring must be connected by professional technicians according to the wiring diagram.
- b. The heat pump must be connected to an appropriate circuit breaker in accordance with the current standards and regulations of the country where the system is installed.
- c. Connect to a suitable power supply, and the voltage should comply with the rated voltage of the equipment.
- d. For three-phase systems, they must be connected in the correct phase sequence. If the phases are reversed, the heat pump compressor will not work.
- e. Make sure the heat pump is well grounded.
- f. The power supply cable must be suitable for the rated power of the equipment and the wiring length required for the installation. The cable must be suitable for outdoor use.
- g. In places open to the public, an emergency stop switch must be installed near the heat pump.
- h. Power cords and signal lines should be arranged neatly and not affect each other.

The recommended cable specification of each model is shown in the following table.

Model	Power Supply	Cable Specification (Max. Recommended Value)
22kw	220-240V~/ 50Hz	3G 4.0mm <sup>2</sup>

26kw
32kw

3G 4.0mm <sup>2</sup>
3G 6.0mm <sup>2</sup>

## (2) Wiring Instruction

**WARNING:** Power to the heat pump must be disconnected before performing any wiring work.

Follow the instructions below to connect your heat pump with cables.

Step 1: Use a screwdriver to remove the top panel of the device for wiring.

Step 2: Connect the cable to the corresponding port of the heat pump as shown below.

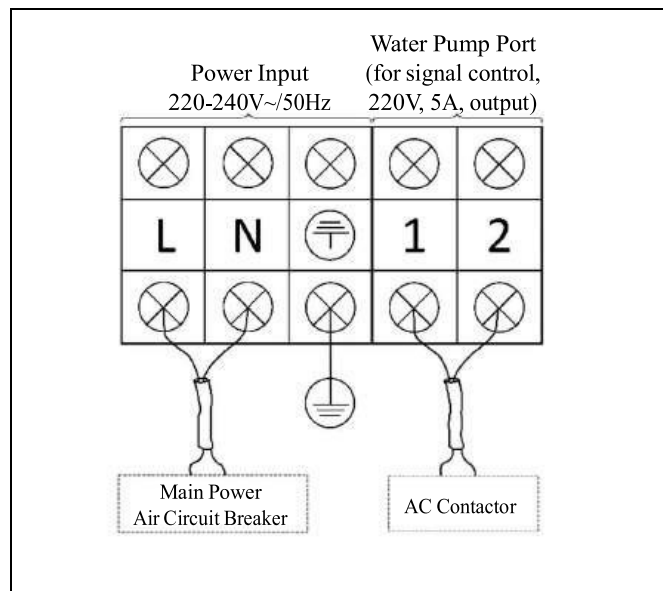

## 4. TESTING

### 4.1. Initial Inspection

Make sure that the following items are complied with. a.

The heat pump is installed correctly.

b. Pipes and wires are connected correctly.

c. The power supply voltage is the same as the rated voltage of the unit.

d. The leakage protector works normally.

e. The ground wire is connected correctly.

- f. Drainage is smooth and there is no water leakage.
- g. Pipe insulation is completed.
- h. The air in the duct has been exhausted.
- i. Refrigeration pipes or components are not installed in corrosive environments.

## 4.2. Leakage Detection

All the following operations must be performed by professionals. a.

It is prohibited to use fire sources during leak inspection.

- b. Leak detection fluid is suitable for most refrigerants, but chlorine-containing cleaners cannot be used because chlorine may react with the refrigerant and corrode the copper pipes.
- c. Leak inspection must be done in a ventilated area. It is prohibited to detect the leakage in closed areas.
- d. When refrigerant leakage occurs, stop using the equipment immediately and contact the service center professionals.
- e. If welding is required, complete vacuuming is required before welding.

## 4.3. Trial Operation

Step 1: The user must turn on the water pump first and then the heat pump. Turn off the heat pump first, then the water pump. Otherwise the equipment will be damaged.

Step 2: Before starting the heat pump, check for water leaks, set the appropriate temperature, and then turn on the power.

Step 3: Check the following items during trial operation.

- a. Is there any abnormal noise or vibration during operation?
- b. Is there any leakage in the entire gas system?
- c. Are all the keys of wire controller normal?
- d. Is the display of wire controller normal?
- e. Is the current normal?
- f. Is the condensed water discharge normal?

# 5. OPERATION

## 5.1. Overview of Wire Controller







### 5.1.1. Icon







Icon	Meaning	Icon	Meaning
	Auto Mode		Degree Celsius
	Cooling Mode		Degree Fahrenheit
	Heating Mode		Boost Mode
	Defrosting Mode		Smart Mode
	Fault or Protection		Silence Mode
	Wi-Fi		Time or Parameter
	Set Water Temp.		Timer ON/OFF
	Current Water Temp.		Lock

### 5.1.2. Key

No.	Key	Meaning	Function



1		Mode 1	Switch between Auto, Cooling and Heating Mode
2		Mode 2	Switch between Boost, Smart and Silence Mode
3		Up	Increase the Value
4		Down	Decrease the Value
5		Power	Press to turn On or Off the heat pump; Press and hold for 3 seconds to lock or unlock the wire controller

### 5.1.3. Keys Combination

No.	Combination	Function
1	Press the keys “  and “  ” and then hold for 2 seconds	Enter Parameter Checking Interface
2	Press the keys “  and “  ” and then hold for 2 seconds	Enter Timer Setting Interface
3	Press the keys “  and “  ” and then hold for 3 seconds	Search for a Wi-Fi Signal and Connect to Wi-Fi

## 5.2. Operation of Wire Controller





### 5.2.1. Power

Press the key “” to turn on or off the heat pump. Press the same key “” and then hold for 3 seconds to lock or unlock the wire controller. When the wire controller is locked, the icon “” played on the screen. The wire controller will be automatically locked after 120 seconds of inactivity.

### 5.2.2. Mode

#### a. Heating/Cooling/Auto









When the heat pump is on, press the key “” switch between mode Heating “” Cooling “” and Auto “”.

Note: When Auto mode is chosen, the icon “” will be displayed. In this mode, the heat pump intelligently chooses the most appropriate operating mode according to the setting water temperature and the current water temperature: When executing Auto Heating mode, both icons “” and “” will be displayed; When executing Auto Cooling mode, both icons “” and “” will be displayed.



#### b. Boost/Smart/Silence

When the heat pump is on, press the key “” to switch between mode Boost “”, Smart “” and Silence “”.





### 5.2.3. Temperature Setting

When the heat pump is on, press the keys “” “” to adjust the setting within the temperature area under current mode. The setpoint can be seen in this area “” real-time current water temperature “” “” area “”. For rapid adjustment, press the key “” or “” and then hold for longer than 0.5 seconds.

### 5.2.4. Wi-Fi Connection

Press both keys “” and “” and then hold for 3 seconds to connect to Wi-Fi. The icon “” will be flashing during connecting. This icon will remain displayed after successfully connected.

### 5.2.5. View Operating Parameters

- The way to enter the interface of operating parameter: Press the keys “” and “” and then hold for 2 seconds. Then the code of operating parameter is shown in the timing display area, and parameter content is shown in the current water temperature display area.
- The way to view the operating parameters: After entering the parameter interface, press the key “” or “” to view the operating parameters. To exit this interface, press the key “”. If no operation for 60 seconds, it also exits automatically.



### List of Operating Parameter

Code	Parameter Name	Unit	Scope	Remark
01	Practical Frequency of Inverter Compressor	Hz	0~150	
02	AC Current	A	0~50	
03	AC Voltage	V	0~300	

04	DC Voltage	V	0~500	
05	Inlet Water Temperature	°C	-30~150	
06	Outlet Water Temperature	°C	-30~150	
07	Water Tank Temperature	°C	-30~150	Not for pool heat pump
08	Tube in Shell Heat Exchanger Temperature	°C	-30~150	Not for pool heat pump
09	Outdoor Coil Temperature	°C	-30~150	
10	Outdoor Air Temperature	°C	-30~150	
11	Gas Suction Temperature	°C	-30~150	
12	Gas Exhaust Temperature	°C	0~150	
13	Water Inlet Temperature of Plate Heat Exchanger	°C	-30~150	Not for pool heat pump
14	Outlet Water Temperature of Titanium Heat Exchanger	°C	-30~150	Not for pool heat pump
15	Step of Electronic Expansion Valve in Main Circuit	P	0~500	Number of pulses
16	Step of Electronic Expansion Valve in Auxiliary Circuit	P	0~500	Not for pool heat pump
17	IPM (Driver Module) Temperature	°C	0~150	Reserved (default value: -30)
18	Speed of DC Fan Motor	RPM	0~900	

### 5.2.6. Fault and Protection

When the fault or protection occurs, the corresponding codes flash in the timing area and the icon

“” is displayed. After this status is eliminated, the codes and icon “” disappear.







#### List of Fault and Protection

Code	Description	Remark
E01	IPM (Driver Module) Protection	
E02	AC Voltage Over/Shortage Protection	Input voltage inspection
E03	AC Current Over High Protection	
E04	Gas Exhaust Temperature Over High Protection	
E05	Outside Coil Temperature Over High Protection	

E06	Compressor Drive Protection	
E07	Air Temperature Sensor Fault	
E08	Outside Coil Temperature Sensor Fault	
E09	Gas Exhaust Temperature Sensor Fault	
E10	Bus Voltage Over/Shortage Protection	Voltage protection after rectification
E11	Current Sensor Fault	
E12	Compressor Driver Communication Fault	
E13	DC Fan Motor Fault	
E14	Gas Suction Temperature Sensor Fault	
E15	Driver's EE Fault	
E16	Main Control Board's EE Fault	
E17	Low Pressure Protection	
E18	High Pressure Protection	
E19	IPM Temperature Over High Protection	
E20	Power Off Suddenly	Automatic power on after recovery
E21	Evaporation Temperature (T2) Over Low Protection	
E22	Communication Error between Wire Controller and Main Control Board	
E23	Phase-shortage Protection	
E24	Inlet Water Temperature Sensor Fault	
E25	Outlet Water Temperature Sensor Fault	
E26	Water Flow Switch Fault	
E27	Inadequate Water Flow Protection	
E28	Outlet Water Temperature Over High Protection in Heating Mode	
E29	Outlet Water Temperature Over Low Protection in Cooling Mode	
E30	Evaporation Temperature Sensor (T2) Fault	

E33	PFC Hardware F0 Error	Driver error
E34	PFC Software Over Current Protection	Driver error
E35	Compressor Step-lost	
E37	Compressor Startup Failure	







### 5.2.7. Clock Setting



- a. The way to enter clock setting interface: Press the key  and then hold for 3 seconds till the number in hour part of timing area flashes. Then the clock setting interface is entered.
- b. The way to set the clock: When the number in hour area is flashing, it means it is adjustable. Press the key “” or “” to adjust Hour; Then press the key  to confirm and switch to Minute part. Repeat above steps to set the minute. After finishing setting, press the  to save it and then press the key “” to exit the setting interface.

### 5.2.8. Power ON/OFF Timer Setting

- a. Users can set up two groups of timers to automatically turn ON or OFF the heat pump. If the timers of power ON and OFF are set to be the same, the setting will become invalid.





#### b. Power ON/OFF Timer Setting Method

Press the keys “” and “” and then hold for 3 seconds till the icons “” and “**1**” are displayed on the screen. When the icon “**1**” is flashing, press the key  “” to select group NO.1 or group NO.2 of timer, and then press the  to confirm.

When the number in Hour area is flashing and the icon “**ON**” is displayed, press the key “” or “” to set the hour of timing ON of group NO.1 (or NO.2). Then press the key  to



confirm and switch to set the minute while the number in Minute area is flashing. Repeat the above steps and then press the key “ ” to confirm.

c. After finishing the setting of the group NO.1 (or NO.2) timing ON, it will automatically switch to the timing OFF setting interface. When the icons  (or  ) and **OFF** are displayed, press the key  ” or  ” to set the hour of timing OFF of group NO.1 (or NO.2). Then press the  ” to confirm and switch to set the minute while the number in Minute area is flashing.

Repeat the above steps and then press the key “  ” to confirm.



d. The way to exit the interface of timer ON/OFF setting: Short press the key “  ” during setting, the setting interface will be exited and the current setting will no longer be saved.

e. The way to cancel timer ON/OFF setting: When entering timer group NO.1 (or NO.2) setting interface, press the key “  ” and then hold for 3 seconds to cancel the current timer group (NO.1 or NO.2).

## 5.3. Connection and Operation of APP

### 5.3.1. APP Download

Search “Smart Life” in app store of your mobile phone and then download it.

App Icon	iOS system download it from:	Android system download it from:
 Smart Life		

Or you can download the app from scanning the following QR code.



Note: For Android mobiles, it is necessary to activate the option of "Download apps from external sources".

Open the APP and activate the authorization of its positioning.

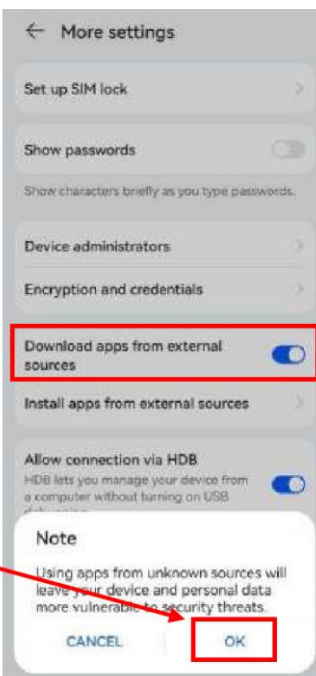

The screenshot shows the 'More settings' screen on an Android device. The 'Download apps from external sources' option is highlighted with a red box and is turned on. Below it, a warning dialog box is displayed with the text: 'Note: Using apps from unknown sources will leave your device and personal data more vulnerable to security threats.' The 'OK' button in the dialog box is also highlighted with a red box. A red arrow points from the text box on the left to the 'OK' button.

### 5.3.2. User Registration

(1). For new user, tap the following “Sign Up” button to register a new account. (2). Follow the instruction to finish your registration.

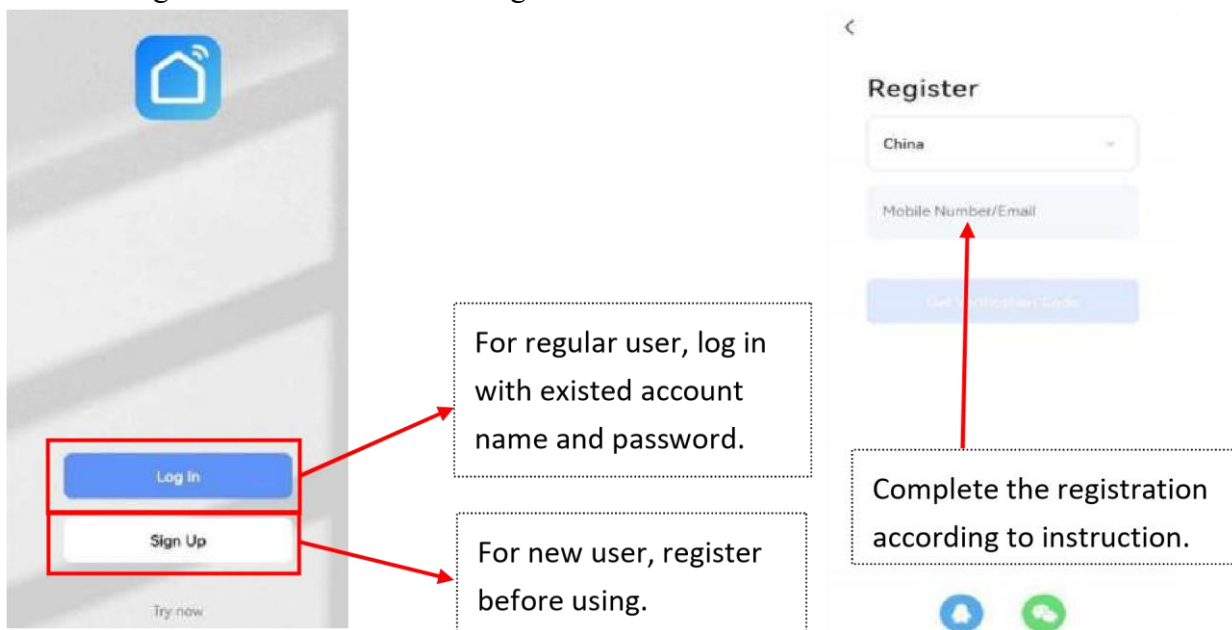

### 5.3.3. User Login

Select your location, enter the account name and password, and then agree the Privacy Policy.

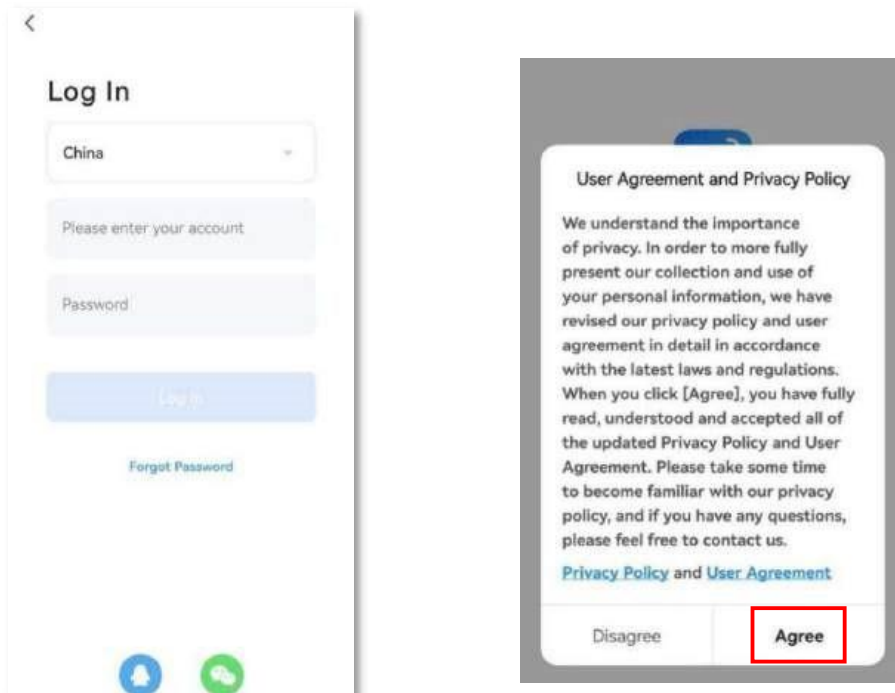

Connect your mobile phone to the accessible Wi-Fi (the one that the heat pump device is connected to). Additionally, keep Bluetooth of your mobile phone on during this process.

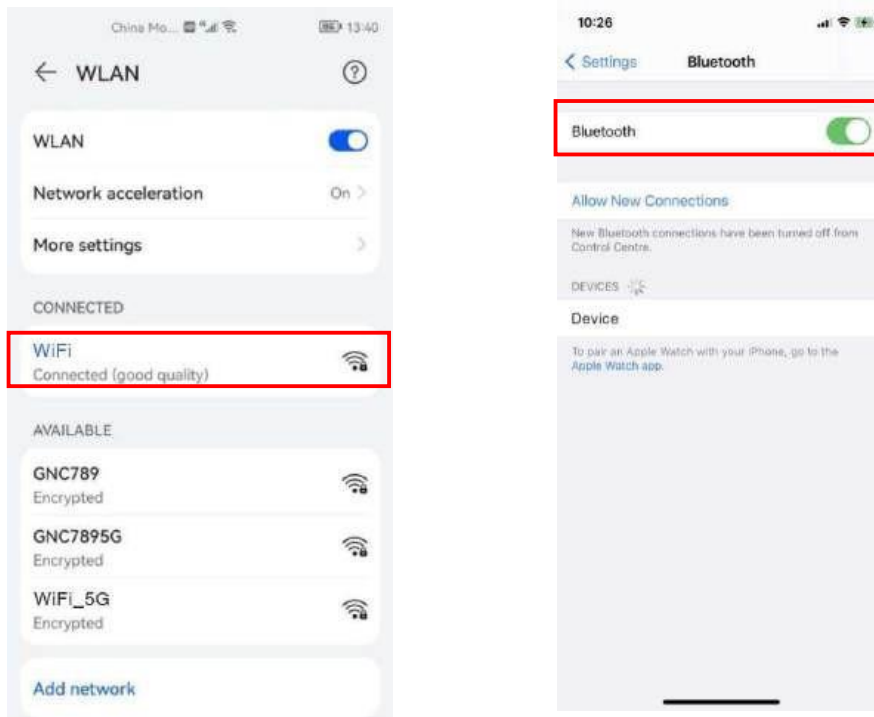

Make sure your Location Services on your smartphone are kept "On" and also enable "Allow Apps to Request to Track".

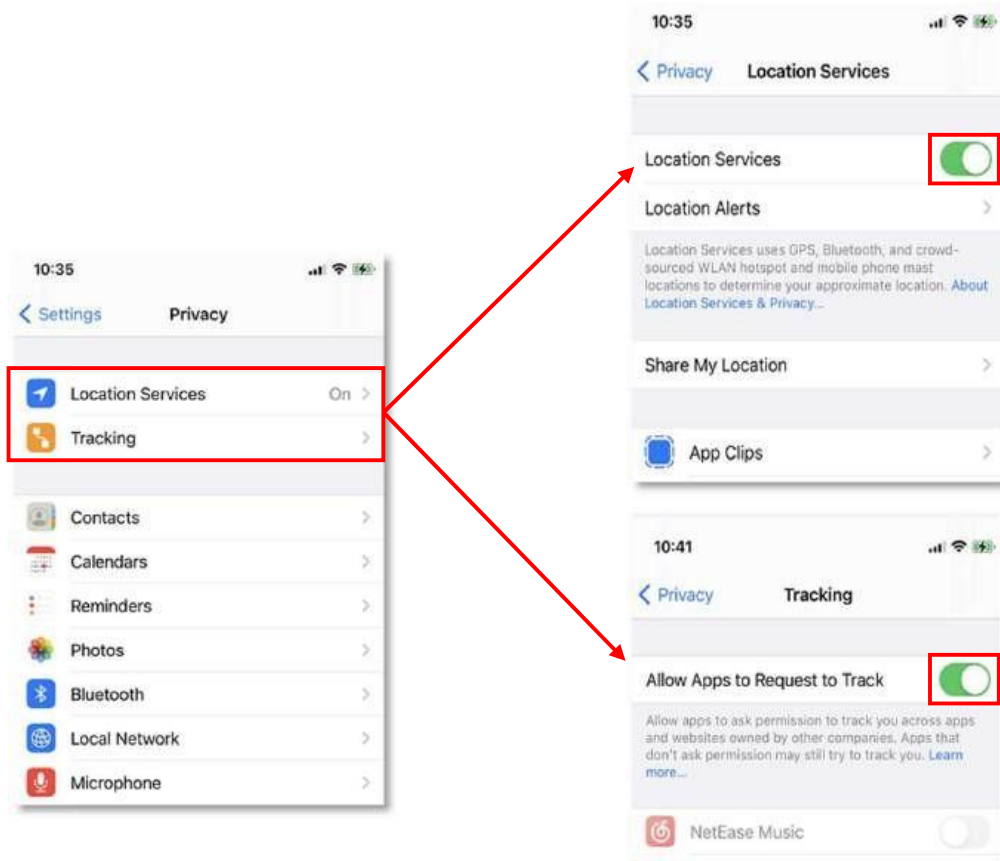

### 5.3.4. Add Device

Tap the button “+” at the right upper corner, or tap button “Add device” to add the smart device you want to connect.

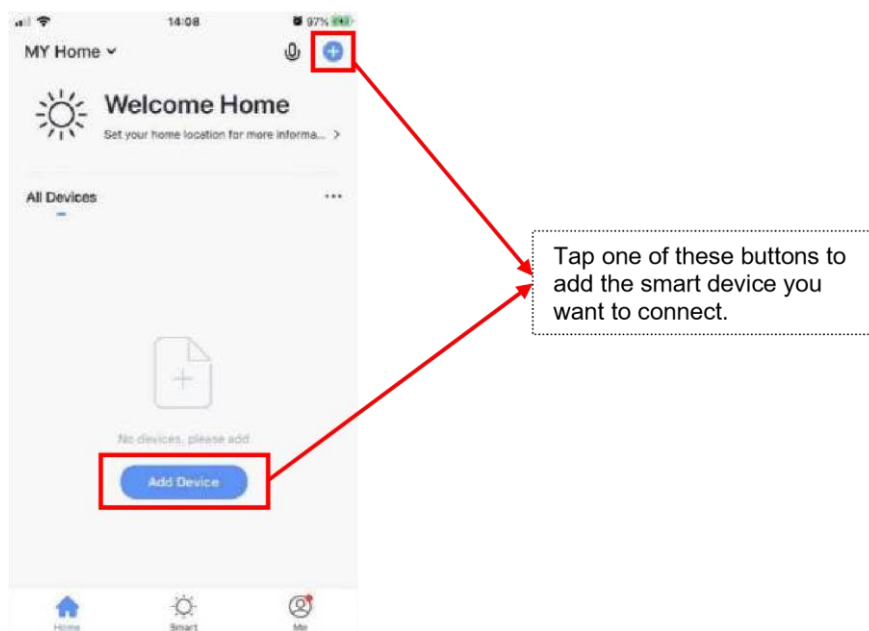

Select “Others” to enter the “Add Manually” interface. And then select “Others (Wi-Fi)”.

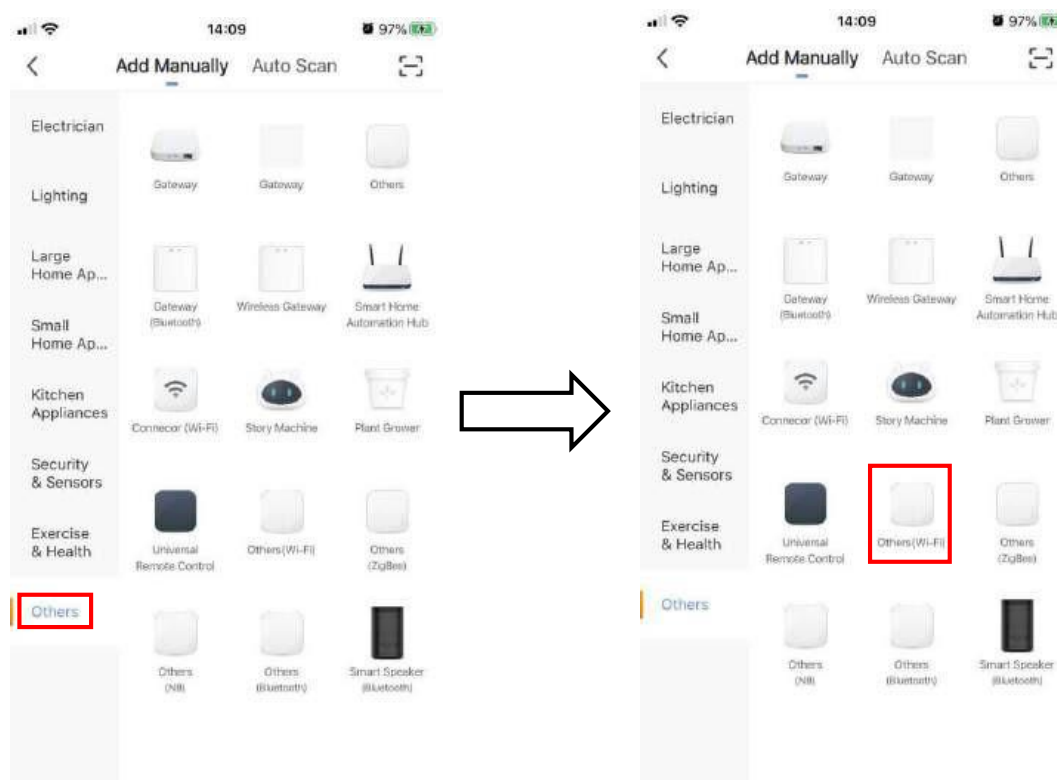

Then enter the account and password of the Wi-Fi (the same Wi-Fi source as the heat pump device connects) in following new interface:

After entering the above information, tap the button “Next”.





### 5.3.5. Connection

When you enter this interface, tap button below.



Then, operate the wire controller of heat pump according to the following instruction:

Press these two buttons  and  at the same time until the icon  on the right upper corner starts to flash.

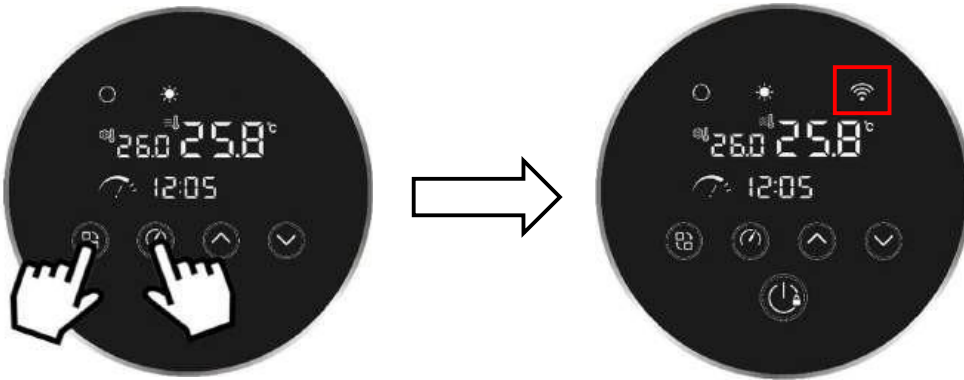

Scene 1:

If the icon  flashes slowly, tap the following button “Blink Slowly” on your mobile phone.

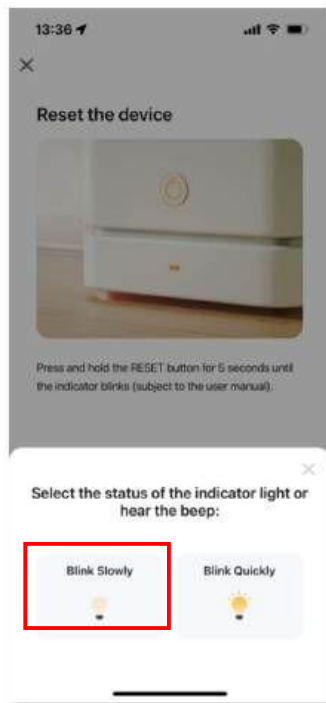

And then tap the following button in the new interface.



Select the WLAN source of “SmartLife-XXXX” (“XXXX” will be random combination of letters and numbers). And then get back to the Smart Life app.



When the following page appears, it indicates that your mobile phone is scanning for the hotspot signal from the wire controller of the heat pump.

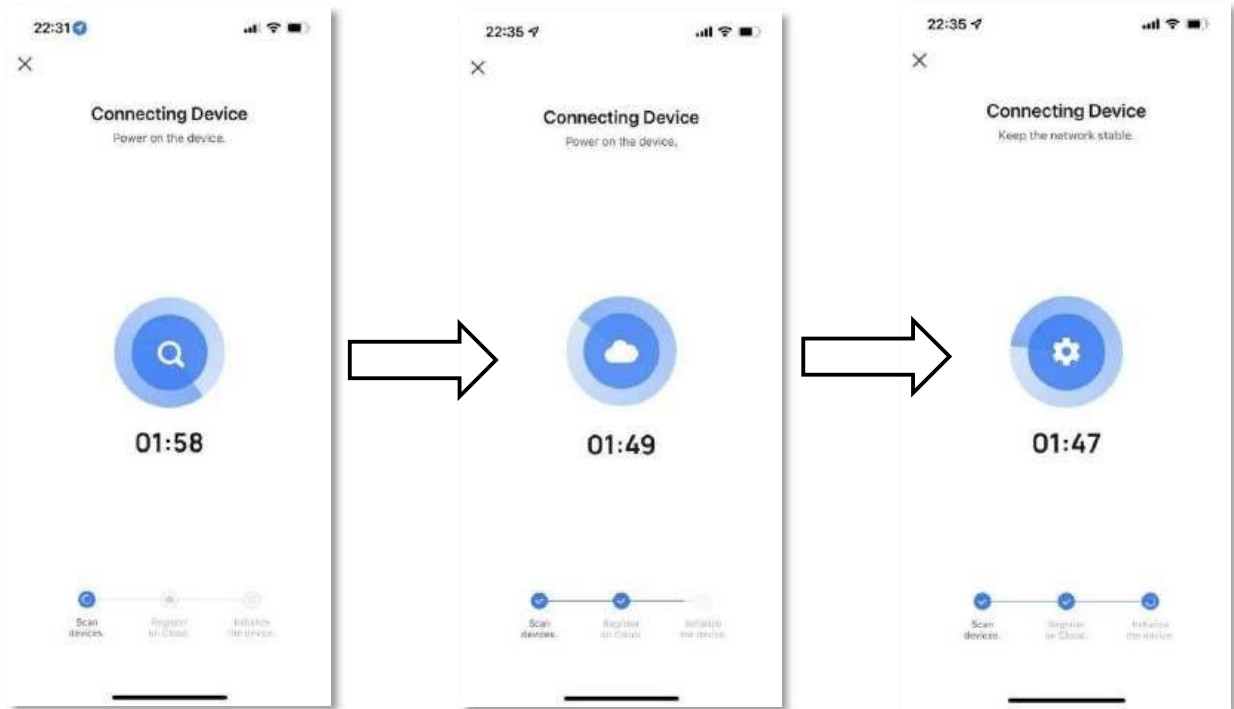

Upon the appearance of this page, it implies that the connection has been established successfully. Subsequently, tap on the button "Done" to access the Wi-Fi control interface.



### Scene 2:

If the icon  flashes rapidly, tap the following “Blink Quickly” button on your mobile phone.



Then tap the following button “+” in the new interface. After the connection is successful, tap on the button "Done" to access the Wi-Fi control interface.

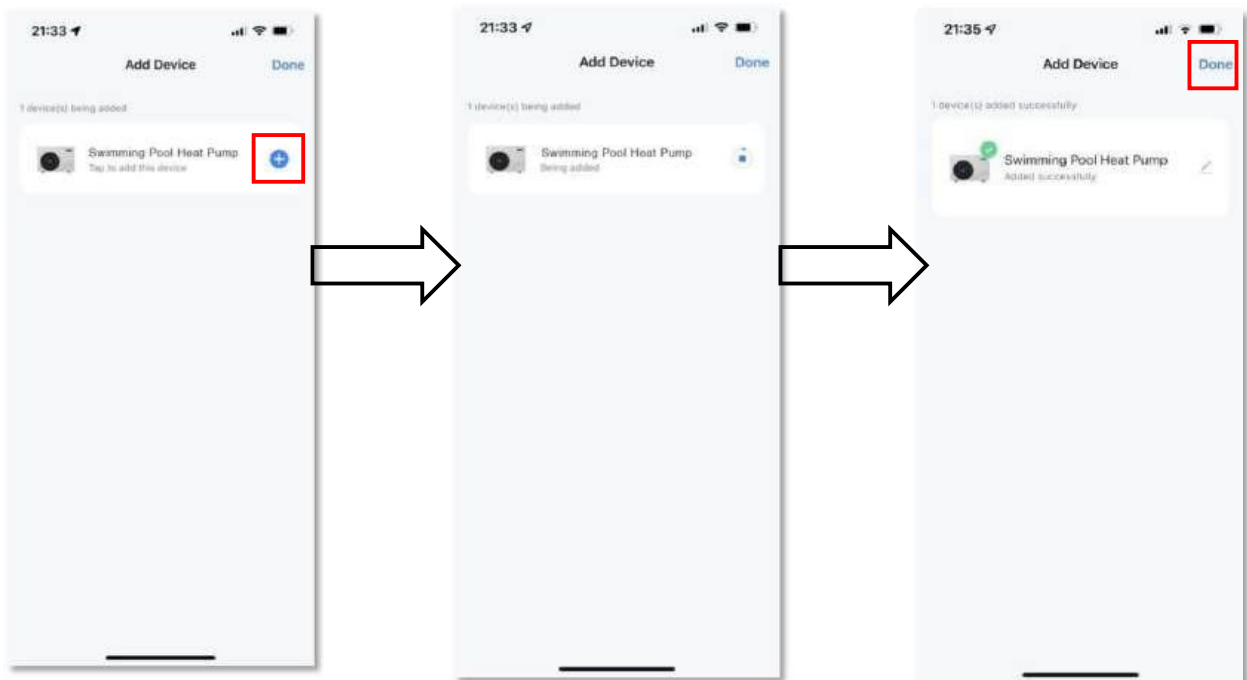

### 5.3.6. Wi-Fi Control Interface

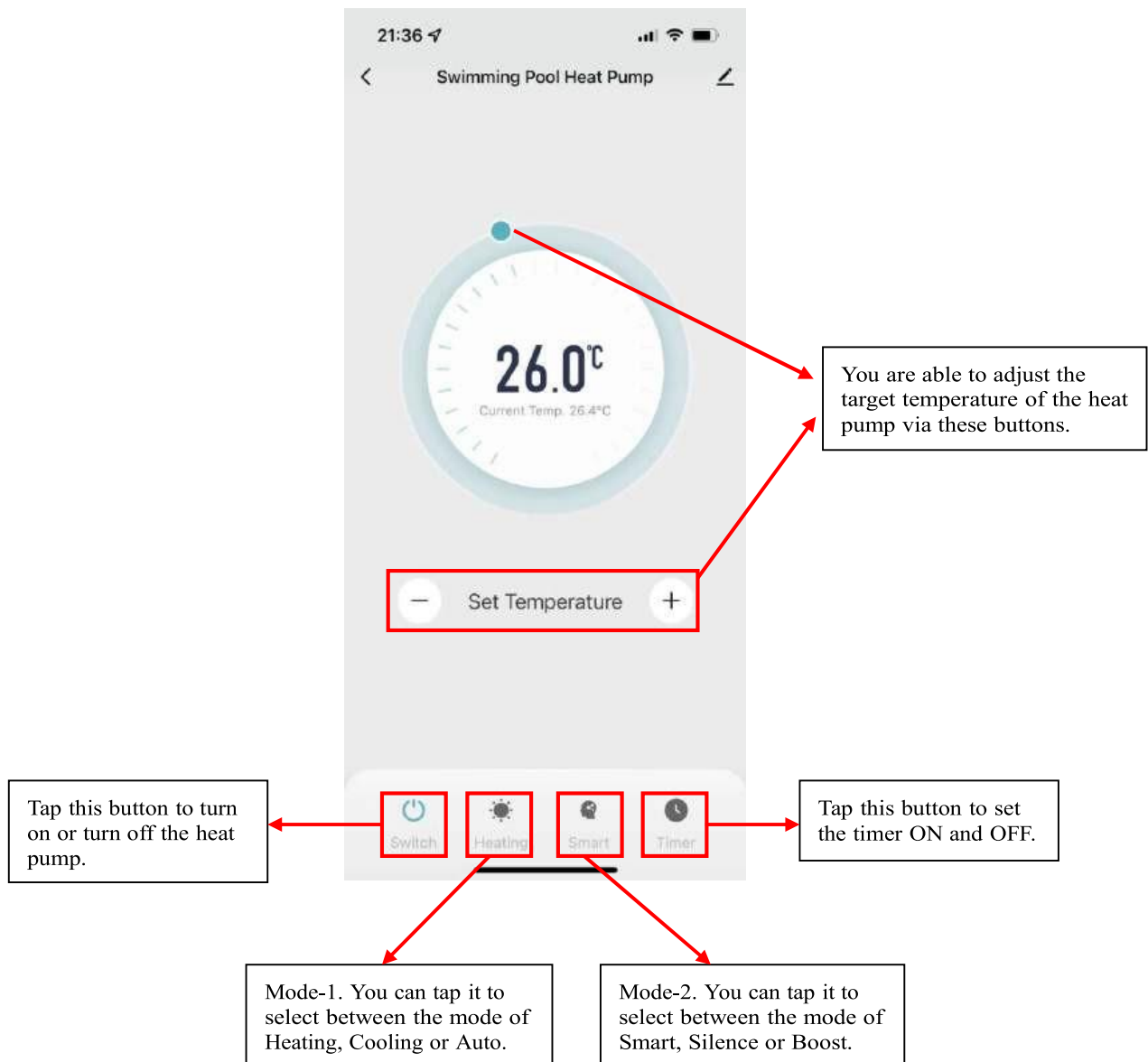

### 5.3.7. Share Device to Your Family Members

After the connection is established, if other family members wish to control the heat pump as well, they are required to register for "Smart Life" initially. Subsequently, the administrator can follow the steps below to share the device:

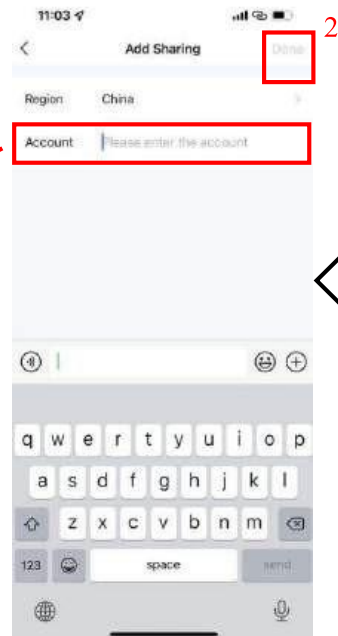
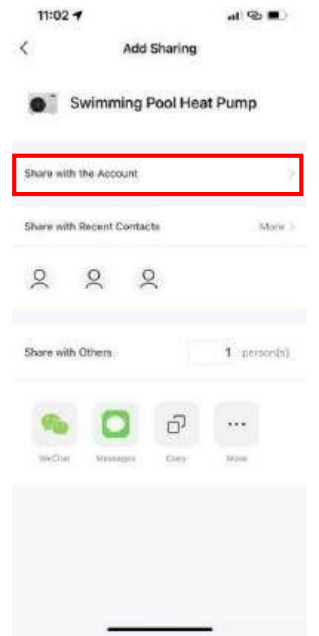
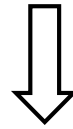
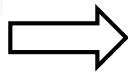
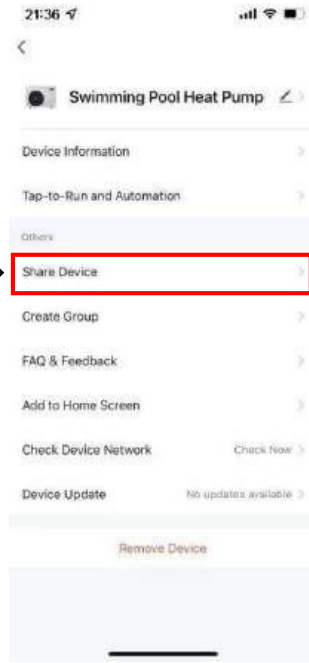
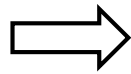

Enter the phone number or email that your family member used to register the “Smart Life” app. And then tap “Done” to finish.

Remark: The app is subject to updates without notice.

## 6. MAINTENANCE

Warning: Before maintaining the equipment, make sure the power supply is turned off.

### 6.1. Cleaning

- a. Do not use a hard brush to scrub the surface of the machine.

- b. Use household cleaners or water to clean the machine. Do not use gasoline, thinner or any similar fuel.
- c. If there is garbage attached to the air inlet or outlet, it needs to be cleaned up in time.
- d. Clean the finned-tube heat exchanger of the heat pump by using a vacuum cleaner or soft brush.

## 6.2. Inspection

The following checks should be performed regularly:

- a. Clean the pool and filter system to avoid dirty or clogged filters that could damage the unit.
- b. The water supply system should be checked to avoid air entering the water system and low water flow, which would reduce the performance and reliability of the unit.
- c. Check and confirm that there is enough water flow before starting the unit again.

The following operations must be performed by qualified personnel at least once a year: a.

Check for refrigerant leaks.

- b. Check the connections and integrity of the wires.
- c. Check that the machine is still grounded.
- d. Check if there is any abnormal sound when the device is running
- e. Check for loose bolts and screws.

## 6.3. Winterizing

When not swimming in winter:

- a. Cut off the power supply to prevent damage to the equipment.
- b. Drain the water in the machine: Unscrew the water joint of the water inlet pipe and let the water flow out. (The water in the machine freezing in winter may damage the titanium heat exchanger.)

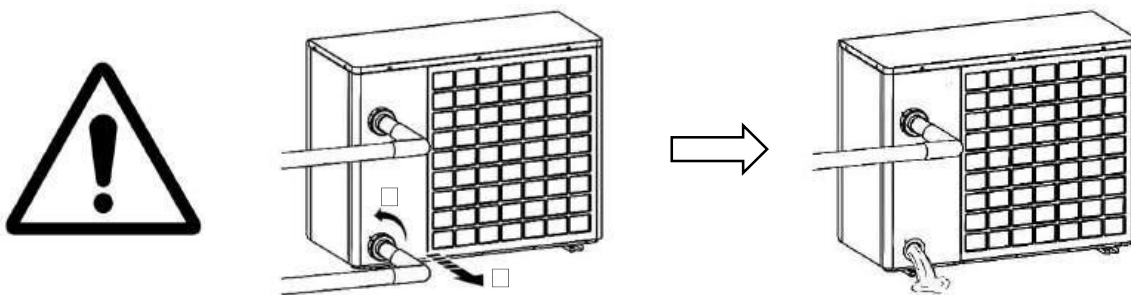

Keep your heat pump covered with a winter cover when not in use.

## 6.4. Warranty

Our product range comes with a limited 7-year warranty covering any component failure or defective workmanship from the installation date a further 10 years on the compressor and 25 years on the titanium components in the heat exchanger.

GENERAL

1.1 This warranty is provided by Austek pool heaters Pty Ltd.

1.2 For the purposes of this document, the Austek heat pump swimming pool heater is referred to as the “unit.”

1.3 Austek offers a trained and qualified national service network to repair or replace components at the location of the heat pump, subject to the terms of this warranty. Austek Service can also provide preventative maintenance and operational advice; however, it cannot give site-specific advice and would be recommended to speak to the original installer or dealer.

1.4 For more details about this warranty, please visit [www.Austekpoolheaters.com.au](http://www.Austekpoolheaters.com.au)

1.5 If a subsequent version of this warranty is published, the terms of that warranty will apply to units manufactured after the date specified in the subsequent version.

1.6 The application of this warranty is contingent upon payment for the unit being made in accordance with the Company's Standard Terms and Conditions.

## 1. TERMS OF THE AUSTEK WARRANTY AND EXCLUSIONS

2.1 The warranty period commences from the end user's date of purchase.

2.2 The decision to repair or replace a faulty component is at Austek's sole discretion.

2.3 If you require a call-out and the fault is not covered by the Austek warranty, you are responsible for our standard call-out charge. If you wish to have the relevant component repaired or replaced by Austek, that service will be at your cost.

2.4 Where a failed component is replaced under this warranty, the balance of the original warranty period remains effective. The replacement does not carry a new Austek warranty.

2.5 If the unit is installed in a position that does not allow safe or ready access, the cost of that access, including the cost of additional materials handling and/or safety equipment, will be the owner's responsibility. This includes the cost of dismantling or removing cupboards, doors, or walls, and any special equipment to bring the pool heater to floor or ground level or to a serviceable position.

2.6 This warranty only applies to the original and genuine Austek unit in its original installed location and any genuine Austek replacement parts.

2.7 The Austek warranty does not cover faults resulting from:

- a) Accidental damage to the unit or any component (e.g., acts of God such as floods, storms, fires, lightning strikes, and third-party acts or omissions).
- b) Misuse or abnormal use of the unit.
- c) Installation not in accordance with the Owner's Guide and Installation Instructions or with relevant statutory and local requirements in the State or Territory where the unit is installed.
- d) Connection of the unit in any way that does not comply with the guidelines outlined in the Owner's Guide and Installation Instructions.
- e) Repairs, attempts to repair, or modifications to the unit by anyone other than Austek Service or an Austek Accredited Service Agent.
- f) Faulty plumbing or faulty power supply.
- g) Failure to maintain the unit in accordance with the Owner's Guide and Installation Instructions.
- h) Transport damage where freight is arranged by others.
- i) Fair wear and tear from adverse conditions (e.g., corrosion).
- j) Cosmetic defects.

2.8 Subject to any statutory provisions to the contrary, this warranty excludes all claims for damage to furniture, carpet, walls, foundations, or any other consequential loss either directly or indirectly due to leakage from the unit, or from fittings and/or pipe work of metal, plastic, or other materials caused by water temperature, workmanship, or other modes of failure.

2.9 This warranty is void if the unit is installed by an installer not approved by Austek or by persons who are not qualified to do so in the opinion of Austek.

2.10 The warranty on the unit's internal heat exchanger covers failure due to water imbalance. It does not cover failure caused by hydraulic damage, such as excess pressure. The extended parts warranty covers the

cost of a replacement heat exchanger but excludes labour or associated costs or the cost of any subsequent damage.

2.11 This warranty does not cover the replacement or replenishment of refrigerant within the unit.

2.12 It is a condition of this warranty that the customer has correctly and precisely stipulated the capacity and performance required of the System and the conditions under which the System shall operate. Any performance figures given in the Quotation or mentioned or referred to before the contract are expectations based on tests but are not guaranteed. All such performance figures, whether analytical or financial, are estimates only, and the customer must independently satisfy themselves of their accuracy and completeness. Failure to perform as specified should be notified to us in writing, and we shall be given every reasonable opportunity to investigate the cause of the failure and recommend remedial action. If it is clearly established that the fault is due to an error in calculation by us or failure by our employees to carry out instructions, we will rectify the fault at no cost to the customer within a reasonable time period.

### 3. WHAT IS COVERED BY THE AUSTEK WARRANTY

3.1 Austek will repair or replace a faulty component of your unit if it fails to operate in accordance with its specifications in the opinion of Austek.

### 4. ENTITLEMENT TO MAKE A CLAIM UNDER THIS WARRANTY

4.1 To make a claim under this warranty, you need to:

- a) Be the owner of the unit or have the consent of the owner to act on their behalf.
- b) Contact Austek Service without undue delay after detection of the defect and within the applicable warranty period.

4.2 You are not entitled to make a claim under this warranty if your unit:

- a) Does not have its original serial numbers or rating labels.
- b) Is not installed in Australia.

### 5. HOW TO MAKE A CLAIM UNDER THIS WARRANTY

5.1 To make a claim under this warranty:

- a) Contact Austek at [info@austekpoolheaters.com.au](mailto:info@austekpoolheaters.com.au) and provide the owner's details, the address of the unit, a contact number, and the date of installation of the heater, or if that's unavailable, the date of manufacture, model, and serial number (from the rating label on the heater).
- b) Austek will arrange for the heater to be tested and assessed on-site.
- c) If Austek determines that you have a valid warranty claim, Austek will repair or replace the heater in accordance with this warranty.

5.2 Any expenses incurred in making a claim under this warranty will be borne by you.

### 6. THE AUSTRALIAN CONSUMER LAW

6.1 Our goods come with guarantees that cannot be excluded under the Australian Consumer Law.

You are entitled to a replacement or refund for a major failure and compensation for any other reasonably foreseeable loss or damage. You are also entitled to have the goods repaired or replaced if the goods fail to be of acceptable quality and the failure does not amount to a major failure.

6.2 The Austek warranty is in addition to any rights and remedies that you may have under the Australian Consumer Law.

#### Making a Claim

The following steps should be taken when making a warranty claim with Austek Pty Ltd.

1. Owners experiencing issues with their system are to contact Austek Pty Ltd service department's online portal and provide the requested information.

- 
2. A service agent will review the provided information and will contact you on the provided phone number to try and solve the issue.
  3. If the issue cannot be dealt with over the phone, owners will be supplied with details of a service agent in their area.
  4. Owners will need to contact and deal with service agents directly in relation to the booking and payments for works related to the service or repair of their Austek Pool Heat Pump.
  5. Owners can claim reimbursement for costs of works covered under the product warranty when completed by an approved Austek Service Agent. When making a claim, owners will need to provide the following documents:
    - o Proof that you are the original system owner – original invoice showing owner name and property address
    - o Copy of the invoice from an approved Austek-approved service agent
    - o For a major defect, a copy of the report for major defects from an approved Austek Service Agent

---

Please complete all the details below from the installer and store this card along with the purchase docket in a safe place.

Please take 2 or 3 photos of the installation and with this information and send them to [info@austekpoolheaters.com.au](mailto:info@austekpoolheaters.com.au)

---

#### Installation Details

- Make
- Model
- Serial
- Commissioning
- By-pass valve fitted?
- Temperature difference
- Notes
- Supplied by
- Date of Purchase
- Installed by
- Installer No (if applicable)
- Date of Install
- Owner's full name
- Address of Premises

- 
- Telephone number

## AUSTEK POOL HEATERS

[info@austekpoolheaters.com.au](mailto:info@austekpoolheaters.com.au)







