

SOLENOID VALVES FOR VALVE AUTOMATION

BULLETIN  
VAC-2015

# VERSA

Delivering Reliability Under Pressure for 65 Years

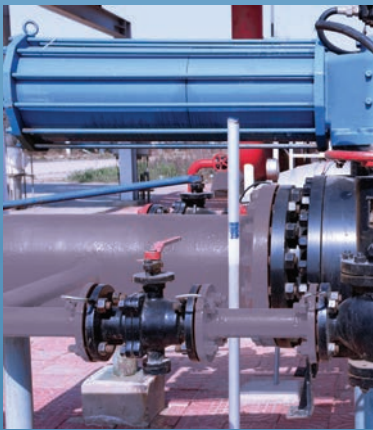

[www.versa-valves.com](http://www.versa-valves.com)  
e-mail: [sales@versa-valves.com](mailto:sales@versa-valves.com)

Versa Products Company, Inc., 22 Spring Valley Road, Paramus, New Jersey 07601 • TEL: 201/843-2400 Fax: 201/843-2931  
Versa BV., Prins Willem Alexanderlaan 1429, 7312 GB Apeldoorn, The Netherlands • TEL: +01131-55-3681900 FAX: +01131-55-3681909

## **QUALITY IS ABSOLUTE**

Quality has no degrees at Versa. There is no such thing as “pretty good” or “almost right”. Every product is designed and manufactured to conform to uniformly high standards.

These standards are assured by a quality management system which includes ISO 9001 certification and testing of all products prior to shipment.

No matter how tough the application or environmental demands, Versa offers you a choice of valves to meet the challenge. Advanced design, durable construction materials and rigid manufacturing standards provide valves you can rely on for years of trouble-free performance.

Be it a single valve or a pneumatic system, Versa’s commitment to quality is uncompromising. Count on it.

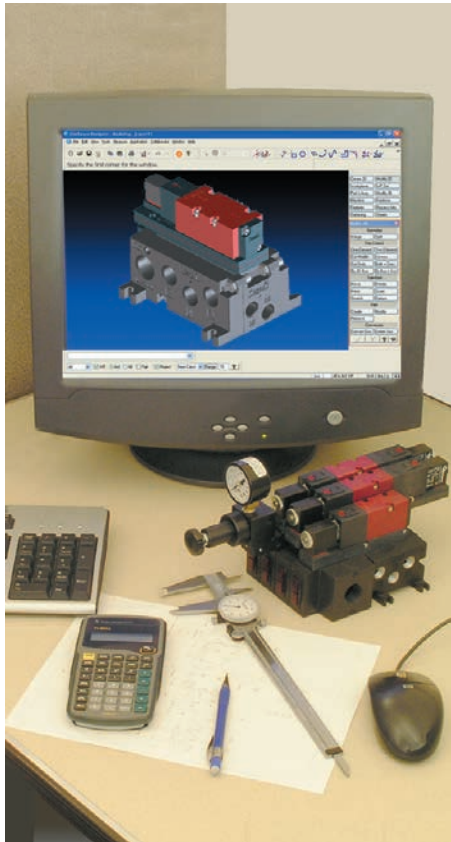

## **THE COMMITMENT CONTINUES**

Fluid Power is our business. It is our only business, so we have to be good at it. Since its beginning in 1949, Versa has maintained its commitment to quality products and satisfied customers.

Versa has succeeded in serving industry’s needs with a broad line of directional control devices. Our focus on product variety, technical expertise and company support remains constant. It all begins with a responsiveness to industry needs and ends with delivery of the valve or system you need—when you need it.

We view ourselves as problem solvers and that role requires more than making good products. It is what we do before and after that is equally important. From drawing board to user satisfaction, our commitment is continuous.



## **HOW WE PUT IT TOGETHER IS WHAT SETS US APART**

Versa is not the biggest manufacturer of directional control valves, so we try to be the best.

Design, manufacture, quality control, pricing, delivery – whatever the function – it must be geared to customer needs.

Many companies sell valves. At Versa, that is not enough. We sell satisfaction.

## **WORLDWIDE ACCESSIBILITY**

More than 500 fluid power representatives and over 100 stocking locations comprise Versa’s worldwide distribution system. They are supported by manufacturing and technical centers in the United States and The Netherlands.

The distributor network is the key to customer service and the source of continuous application feedback. Versa uses this input as part of its research and development program in an effort to respond to individual and industry needs.

Versa makes certain that our distributors’ sales and service personnel receive factory training on an ongoing basis. This includes basic theory, product indoctrination and seminars.

Our distributor family is a source of pride to Versa—but more important—it is a source of support and service to all of our customers.

Contact Versa for the distributor servicing your specific area.



Versa exercises diligence to assure that information contained in this catalog is correct, but does not accept responsibility for any errors or omissions. Versa also reserves the right to change or delete data or products at any time without prior notification. To be sure the data you require is correct, consult factory.

# CONTENTS GUIDE

## Direct Mount Actuator Valves

<b>NAMUR (Series C5) 4-way</b> .....	Page 4, 6 & 7
<b>NAMUR (Series E5) 3-way</b> .....	Page 5,- 7
<b>NAMUR (Series C316) 3-way &amp; 4 way</b> .....	Page 8 - 7

## Bodyported Valves

<b>Aluminum (Series C5 &amp; C7) 3-way &amp; 4 way</b> .....	Page 10 -11
<b>Brass (Series V) 3-way &amp; 4 way</b> .....	Page 12 -14
<b>Stainless Steel (Series E &amp; E5) 3-way</b> .....	Page 15
<b>Stainless Steel (Series C316) 3-way &amp; 4 way</b> ...	Page 16 - 17
<b>Stainless Steel (Series V316) 3-way &amp; 4 way</b> ...	Page 18 - 20

## Lockout Valves:

<b>Brass (Series V) or Stainless Steel (Series V316)</b> 3-way and 4-way .....	Page 21
---	---------

## Special Purpose Dual Solenoid Valves

<b>Brass (Series V) or Stainless Steel (Series V316)</b> 3-Way & 4-Way .....	Page 22 - 23
---	--------------

## Latching/Manual Reset Valves:

<b>Brass (Series V) or Stainless Steel (Series V316)</b> 3-way & 4-way .....	Page 24 - 25
---	--------------

## VMAP:

<b>Stainless Steel (Series V316)</b> Modular Air Package.....	Page 31
--	---------

## Technical Information:

Non-Hazardous Service Solenoids .....	Page 26 -27
Hazardous Service Solenoids .....	Page 28 -29
Miscellaneous Options .....	Page 29
Hazardous Location Combination Suffix Details...	Page 30

<b>Warranty</b> .....	Page 32
-----------------------	---------

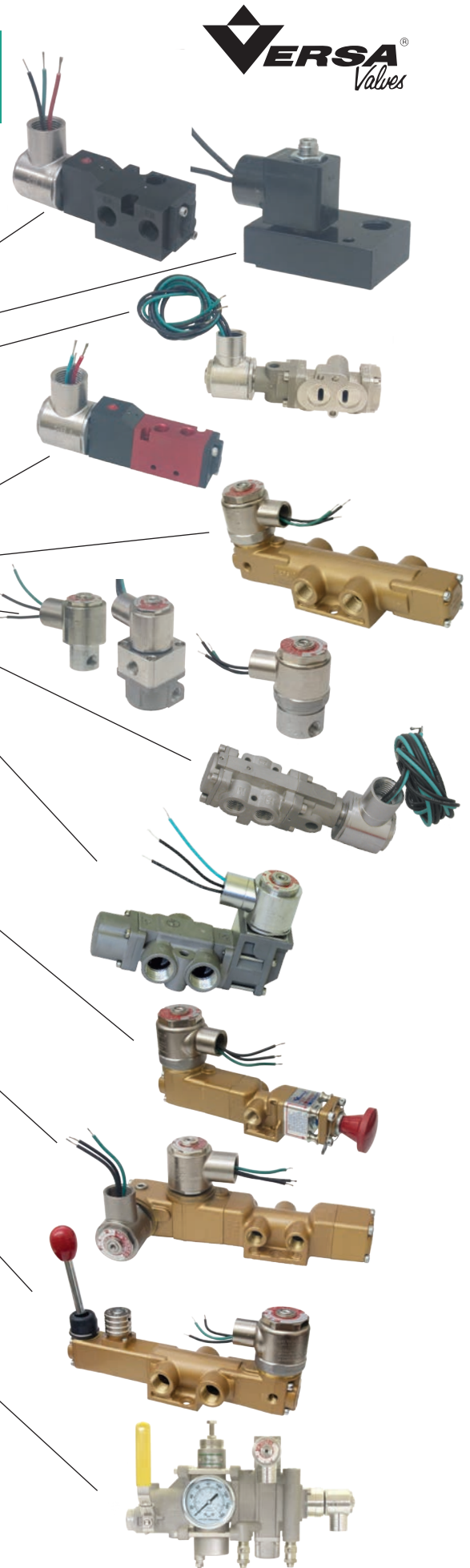

# DIRECT MOUNT ACTUATOR VALVES

ALUMINUM CONSTRUCTION

## SERIES C5 NAMUR

### 3-Way/4-Way Field Convertible Solenoid Valves

#### General Description

The Versa C5 NAMUR mount control valve is a high flow, 5-port, solenoid/pilot valve. It is designed to mount directly to any NAMUR actuator, thus reducing actuator response time and cost of tubing, fittings, brackets, and labor.

The 5-port design allows the C5 NAMUR to be ordered as either 4-way (for double acting actuators) or 3-way (for spring return or fail-safe actuators). The function of this valve is field convertible utilizing no special tools, gaskets, or sealants. Relocation of a port plug converts a 3-way to a 4-way, or a 4-way to a 3-way. When the 4-way valve is converted to 3-way function, the unused exhaust port becomes an actuator vent into which a filter/muffler can be installed to prevent contaminants from entering either the valve or the actuator.

Single solenoid models (for 2-position control), or double solenoid models (for 2 or 3-position control) are available. Actuator positioning is possible with the use of 3-position valves since all Versa C5 NAMUR valves are bubbletight. A complete selection of electrical connections, area classifications, and



power requirements makes the most exacting and demanding specifications or applications easy to satisfy. Manual overrides (guarded-push to operate) are standard on all C5 NAMUR valves. Consult factory for other manual overrides available as an option.

#### Materials

Valve Body and Plunger: anodized aluminum (for stainless steel direct mount valve, See page 8)  
 Actuating Caps: solenoid – anodized aluminum  
 spring cap – synthetic resin  
 Valve Seals: plunger and body – FKM (fluorocarbon)  
 pilot piston – NBR (nitrile)  
 valve/actuator mounting O rings – NBR (nitrile)  
 Pilot Piston: synthetic resin  
 Screws: stainless steel (except valve to actuator = carbon steel)  
 Port Plug: brass  
 Solenoid Parts: sleeve, plunger & spring – 304 & 430F stainless steel  
 coils—epoxy encapsulated with 3 spade terminals (std) or 2 or 3 wire lead (opt)  
 coil cover– (when applicable) option: –C50 = carbon steel, painted;  
 –LB–XN, –LB–XX, –PC, –PC–XN,  
 –PC–XX, –XN, –XX= carbon steel,  
 electroless nickel plated

#### Operating Pressures and Weights

Valve Type	Operating Pressure Range <sup>††</sup> Pneumatic	Approximate Weights	
		Ordinary Service	Hazardous Service
Single Solenoid/Spring Return (2-position)	15-115 psi (1-8 bar)	0.8 lbs. (363 g)	1.1 lbs. (500 g)
Double Solenoid/Detented (2-position)	10-115 psi (0.7-8 bar)	1.2 lbs. (545 g)	1.8 lbs. (816 g)
Double Solenoid/Spring Centered (3-position)	15-115 psi (1-8 bar)	1.2 lbs. (545 g)	1.8 lbs. (816 g)

†† Pressure ranges may change based on solenoid option. See page 6.

$$\text{MPa} = \frac{\text{bar}}{10}$$

For higher pressure applications, consult factory.

#### Porting Size

Inlet and exhaust – 1/4 NPT or G1/4  
 Cylinder ports – O ring seal per NAMUR standard

#### Installation, Filtration and Lubrication

Valves have no limitations on mounting orientation.  
 40 to 50 micron filtration and general purpose lubricating oil ISO, ASTM viscosity grade 32 recommended.  
 Ambient temperature range 5°F (15°C) to 125°F (50°C).

#### Flow Rates

$C_v = 0.75$  ( $K_v = 11$ ) average for all ports (48 SCFM at 100 psi; 82  $\text{Nm}^3/\text{h}$  at 7 bar).

For actuator speed rates see page 6.

#### Options Suffix

Manual Override: none Standard on basic valves,  
 guarded-push to operate.

For other solenoid options see page 6.

## C5 NAMUR Valve Product Number Selector

### Basic Valve Number\*

FUNCTION	PORT SIZE	Cv (Kv)	SINGLE SOLENOID/SPRING RETURN, 2 POSITION	DOUBLE SOLENOID/DETENT, 2 POSITION	DOUBLE SOLENOID/SPRING CENTERED, 3 POSITION	
					Blocked Center	Exhaust Ports Open
4-way 5/2 & 5/3	1/4 NPT G1/4	.75 (11)	CGS-4232-NB1 -†- (coil code)	CGG-4232-NB1 -†- (coil code)	CXX-4233-NB1 -†- (coil code)	CXX-4234-NB1 -†- (coil code)
		.75 (11)	CGS-4292-NB1 -†- (coil code)	CGG-4292-NB1 -†- (coil code)	CXX-4293-NB1 -†- (coil code)	CXX-4294-NB1 -†- (coil code)
3-way** 3/2 & 3/3	1/4 NPT G1/4	.75 (11)	CGS-3232-NB1 -†- (coil code)	CGG-3232-NB1 -†- (coil code)	CXX-3233-NB1 -†- (coil code)	CXX-3234-NB1 -†- (coil code)
		.75 (11)	CGS-3292-NB1 -†- (coil code)	CGG-3292-NB1 -†- (coil code)	CXX-3293-NB1 -†- (coil code)	CXX-3294-NB1 -†- (coil code)

\* All valves include O ring interface seals and #10-24 mounting screws.  
 For #10-32 screws change NB1 to NB2. For M5 screws change NB1 to NB3.

\*\* 3-way is the same valve as 4-way, but is provided with a relocated cylinder port plug. See note on page 7

For coil code see page 6.  
 †Add suffix option here, if required.

# SERIES E5 NAMUR

## 3-Way Solenoid Valves

### General Description

The Versa E5 NAMUR mount control valve is an inexpensive, simple and effective 3-way direct-acting solenoid valve. It is designed to mount directly to any actuator with NAMUR footprint thus reducing cost of tubing, fittings, brackets and labor.

It is most effective on spring return or fail-safe actuators where high speed open or close is not important, but where cost is a factor. A threaded actuator vent port is standard.

Available as a 3-way, 2-position, direct solenoid, spring return only, and with most of the Versa solenoid options. See page 6.

### Materials

Valve Body: anodized aluminum  
 Valve Seals: body/plunger –NBR (nitrile)  
 valve/actuator mounting O rings –NBR (nitrile)

Screws: (valve to actuator) = stainless steel)

Solenoid Parts: sleeve, plunger & spring – 304 & 430F stainless steel

coils—epoxy encapsulated with 3 spade terminals (std) or 2 or 3 wire lead (opt)  
 coil cover– (when applicable) option:–C50 = carbon steel, painted;  
 –LB–XN, –LB–XX, –PC, –PC–XN,  
 –PC–XX, –XN, –XX= carbon steel,  
 electroless nickel plated

### Operating Pressures and Weights

Valve Type	Operating Pressure Range Pneumatic	Approximate Weights	
		Ordinary Service	Hazardous Service
Single Solenoid/Spring Return (2-position)	0-150 psi (0-10.3 bar)	0.6 lbs (272 g)	0.9 lbs (408 g)

### Porting Size

Inlet and Vent: 1/4 NPT or G1/4  
 Exhaust: #10-32 (1/8 NPT or G1/8 available)  
 Cylinder ports: O ring seal for NAMUR standard  
 (For non-NAMUR actuators, consult factory)

### Installation, Filtration and Lubrication

Valves have no limitations on mounting orientation.  
 40 to 50 micron filtration and general purpose lubricating oil ISO, ASTM viscosity grade 32 recommended.  
 Ambient temperature range 5°F (15°C) to 125°F (50°C).

### Flow Rates

Cv = 0.08 (Kv = 1.2) average for all ports  
 (5 SCFM at 100 psi; 8.5 Nm<sup>3</sup>/h at 7 bar).  
 For actuator speed rates see page 6.

### Options

See page 6.

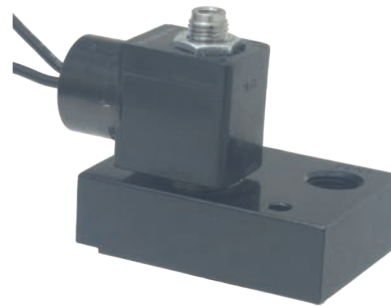

## E5 NAMUR Valve Product Number Selector

				Basic Valve Number*	
FUNCTION	PORT SIZE	Cv	Kv	SINGLE SOLENOID/SPRING RETURN 2-POSITION	
3-Way	1/4 NPT	.08	(1.2)	E5SM-3011-34-NB1 -†- (coil code)	
3/2	G1/4	.08	(1.2)	E5SM-3071-34-NB1 -†- (coil code)	

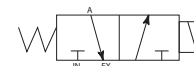

For coil code see page 6.  
 †Add suffix option here, if required.

\* All valves include O ring interface seals and #10-24 mounting screws.  
 For #10-32 screws change NB1 to NB2.  
 For M5 screws change NB1 to NB3.

# DIRECT MOUNT ACTUATOR VALVES

## SERIES C5 & E5 NAMUR Solenoid Options

	NAMUR OPTIONS		VOLTAGES & COIL CODES**		NOMINAL COIL POWER
	DESCRIPTION	SUFFIX DETAIL*	VALVE TYPE		
			C5	E5	
NON HAZARDOUS SERVICE	Spade Terminals (standard)	None			AC=8.5W DC=10.5W
	Strain Relief mini-DIN type connector, cord grip PG9 1/2 NPT conduit mini-DIN type connector 1/2 NPT conduit, watertight, NEMA 4	-HC -HCC -228L	110V50 (E110) 220V50 (E220) 240V50 (E240)	24V60 (A024) 12VDC (D012) 120V60 (A120) 24VDC (D024) 240V60 (A240) 48VDC (D048)	
	1/2 NPT conduit, general purpose, NEMA 1,2,3 1/2 NPT conduit, watertight, NEMA 4 & 4X	-C50 -PC			AC=6W DC=7W
HAZARDOUS SERVICE	<b>Hazardous Locations</b> , UL listed, CSA approved 1/2 NPT conduit, NEMA 7 & 9, -watertight, dusttight, NEMA 4, 4X, 7 & 9, <b>Flameproof (d)</b> - ATEX IECEx EEx II 2 G IIB + H <sub>2</sub> T3 T6* Ex d Ex d IIB T3 to T6 Gb M20 x 1.5 conduit entry, Basic standard with Flameproof Junction Box	-XX -PC-XX  -XN -AJB-PS-XN	110V50 (E110) 220V50 (E220) 240V50 (E240)	24V60 (A024) 12VDC (D012) 120V60 (A120) 24VDC (D024) 240V60 (A240) 48VDC (D048)	AC = 5.6W DC = 7.2W
	<b>Hazardous Locations</b> , UL listed, CSA approved low power, 1/2 NPT conduit, NEMA, 7 & 9, <b>Flameproof (d)</b> - ATEX IECEx EEx II 2 G IIB + H <sub>2</sub> T3 T6 Ex d Ex d IIB T3 to T6 Gb M20 x 1.5 conduit entry with Low power 1.8W coil	-LB-XX  -LB-XN	12V60 (A012) 24V60 (A024) 48V60 (A048) 120V60 (A120) 240V60 (A240)	6VDC (D006) 12VDC (D012) 24VDC (D024) 48VDC (D048) 120VDC (D120)	AC or DC =1.8W
	<b>Intrinsic Safe</b> , Factory Mutual/CSA approved mini DIN connector with strain relief PG9 cord grip with 1/2 NPT conduit entry	-HC-XISC -HCC-XISC	24VDC (D024) SYSTEM VOLTAGE	NOT AVAILABLE	DC=1.6 W MAX
	<b>Intrinsic Safe (ia)</b> - ATEX II 2 G EEx ia IIC T4, to T6** With PG9 cable gland, mini -DIN type connector with 1/2 NPT conduit entry	-HC-XISX6 -HCC-XISX6			
MISC	Silencer/Dust Excluder For Solenoid Exhaust (Not Available For -XISC)	L14			

\* Add option number to basic valve number as suffix

\*\* Add coil code # to end of valve number

\* Add option number to basic valve number as suffix.  
See pages 26/27, 28/29 and 31 for complete description.

\*\* The coil code is shown within the parenthesis following the voltage. Add desired coil code to end of valve number

## NAMUR Actuator Speed Chart

This chart represents approximate actuator operation times under average load conditions at 80 psi (5.5 bar). Due to differing designs of quarter-turn actuators, breakaway friction, loading, internal airflow, inlet piping, fittings and exhaust port options, the values shown are intended as an estimate. Faster or slower times may actually be achieved.

		Actuator Volume in <sup>3</sup> (cm <sup>3</sup> )										
		Valve Type	5 (82)	10 (164)	25 (410)	50 (820)	100 (1640)	150 (2460)	200 (3280)	400 (6560)	600 (9840)	1000 (16400)
ACTUATOR CYCLE TIME IN SECONDS	C5		.32	.36	.47	.63	.98	1.3	1.7	3.1	4.5	7.2
	E5		.46	.64	1.1	2.0	3.9	5.7	7.5	-	-	-
	C316		.19	.21	.25	.35	.55	.65	1.0	1.5	2.2	3.5

For double-acting actuators (open & close), use volume from selected actuator specifications and the chart for estimated speed. The times indicated are per shift. For spring return actuators, use open volume to obtain time

from chart. Actuator spring loading may affect shift time. Slower speeds (adjustable) can always be accomplished by using Versa's Bleed Control Valves in the control valve exhaust port.

# SERIES C5 & E5 NAMUR Dimensions

Shown as inch  
(mm)

Port markings shown are for valves with NPT threads. Port markings for valves with G threads are: (1) = IN; (2) = B; (3) = EB; (4) = A; (5) = EA. Option -PC is shown for reference.

## SERIES C5

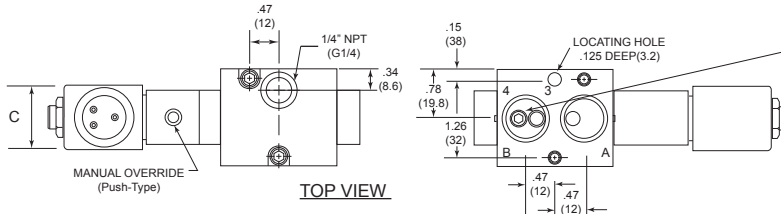

NOTE: THE FUNCTION OF THE VALVE IS FIELD CONVERTIBLE WHEN ORDERING A 4 WAY, CGS-4232-NB1 THE PLUG IS IN POSITION "4" (AS SHOWN) WHEN ORDERING A 3-WAY, CGS-3232-NB1 THE PLUG IS IN POSITION "3" EB BECOMES VENT WHEN USEN AS A 3-WAY

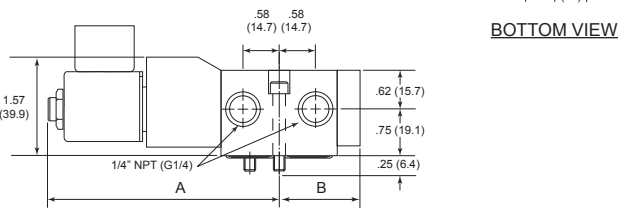

SIDE VIEW (CGS)

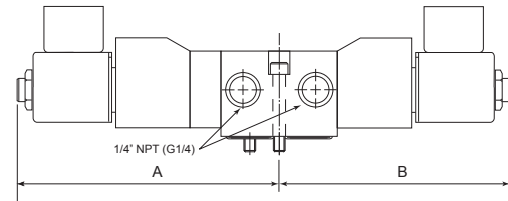

SIDE VIEW (CGG/CXX)

## SERIES E5

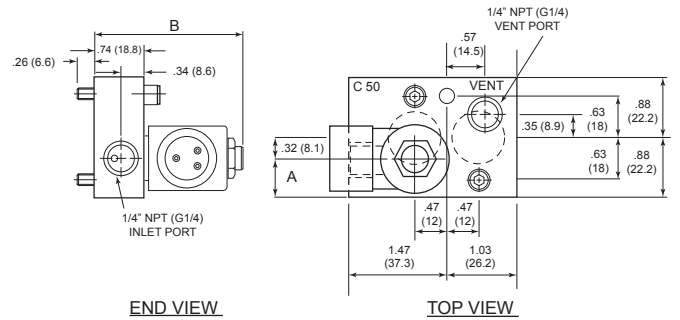

END VIEW

TOP VIEW

NOTES :  
Dimensions show 1/4NPT body markings, G1/4 body markings are: (1) = in; (4) = A; (2) = B; (5) = EA; (3) = EB.  
Options -PC is shown for reference.

E5 NAMUR DIMENSIONS: INCHES (mm)						
Valve Type	Solenoid Option					
	STANDARD, -228L		-C50, -PC		-XX, -XN	
	A	B	A	B	A	B
E5	0.44 (11.2)	2.31 (58.7)	0.52 (13.2)	2.31 (58.7)	.73 (18.4)	2.39 (60.7)

C5 NAMUR DIMENSIONS: INCHES (mm)												
Valve Type	Solenoid Options											
	Standard, -228L			C50, -PC			-XX, -XN			-XISC, -XISX6		
	A	B	C	A	B	C	A	B	C	A	B	C
CSG	3.71 (94.2)	1.31 (33.3)	.885 (22.5)	3.71 (94.2)	1.31 (33.3)	1.04 (26.4)	3.79 (96.3)	1.31 (33.3)	1.45 (36.8)	3.53 (89.7)	1.31 (33.3)	1.15 (29.2)
CGG/CXX	4.21 (106.9)	3.71 (94.2)	.885 (22.5)	4.21 (106.9)	3.71 (94.2)	1.04 (26.4)	4.29 (109.0)	3.79 (96.3)	1.45 (36.8)	4.03 (102.4)	3.53 (89.7)	1.15 (29.2)

# DIRECT MOUNT ACTUATOR VALVES

STAINLESS STEEL CONSTRUCTION

## SERIES C316 NAMUR

### Stainless Steel 3 or 4-Way Solenoid Valves

#### General Description

The Versa C316 Series stainless steel NAMUR mount actuator control valve is a high flow, bubbletight, 5 port solenoid valve. It is designed to mount directly to any NAMUR actuator, thus reducing actuator response time and space. Installed costs are also lower as the need for tubing, fittings, brackets and assembly labor are greatly reduced. All mounting screws and seals are included with the valve.

The 5-port design allows the C316 NAMUR valve to be ordered as either a 4-way for double acting actuators, or as a 3-way for spring return actuators. When the 3-way function is utilized, the unused exhaust port becomes an actuator vent where a filter/muffler can be installed to prevent contaminants from entering either the valve or the actuator. The 5-port design allows the user to independently control actuator speed in either open or close direction by utilizing speed or bleed controls. Single or double solenoid 2-position models are available. Single solenoid spring return models utilize an air assisted spring return feature, assuring a positive return. Double solenoid valves may be used in applications where a momentary signal is required or in a "fail in last shifted position" actuator application. Double solenoid models are equipped with a detent that maintains the valve in the last shifted position, even in high vibration applications. All solenoid actuators are solenoid/pilot type, which allows the use of smaller solenoids resulting in lower power consumption. This design assures a positive shift when the valve is energized and reduces the chance of coil burnout. Manual override for single or double solenoid valves is available as an option.



#### Materials

Valve Body, Actuating Caps & Internal Parts: 316L stainless steel

Valve Seals: FKM (fluorocarbon)

Screws: stainless steel

Solenoid Parts: 304, 430F & 302 stainless steel internal parts; coil/solenoid housing per solenoid option selected

#### Operating Pressure and Weights

Valve Type	*Operating Pressure Range Pneumatic	Approximate Weights		
		General Service	Hazardous Service	
			(-XX, -XN, -XIS_)	(-XMA_, -XIF_)
Single Solenoid-Spring Return	25 to 150 psi (1.8 to 10.3 bar)	1.3 lbs (590 gms)	1.6 lbs (725 gms)	2.5 lbs (1130 gms)
Double Solenoid	15 to 150 psi (1 to 10.3 bar)	1.9 lbs (860 gms)	2.6 lbs (1180 gms)	4.3 lbs (1950 gms)

\* For applications above 125 psi (8.6 bar) exhaust flow controls or mufflers are recommended.

#### Porting Size

Inlet and Exhaust: 1/4 NPT

Cylinder Ports: O ring mount per NAMUR standard

#### Flow Rate

Cv = 1.6 (Kv = 23.5)

#### Actuator Speed

See chart on page 6 for approximate operation times under load conditions at 80 psi (5.5 bar).

#### Installation, Filtration and Lubrication

Valves have no limitation on mounting orientation.

40 to 50 micron filtration is recommended

Lubrication not required.

Ambient and media temperature range -5°F to 200°F (-20° to 93°C)

Low Temperature available consult factory.

#### Solenoid Options

See page 9

### C316 NAMUR Valve Product Number Selector

Basic Valve Number*		
FUNCTION	SINGLE SOLENOID/SPRING RETURN, 2 POSITION	DOUBLE SOLENOID DETENT, 2 POSITION
4-way 5/2	CGS-4332-316-NE1 -†- (coil code) 	CGG-4332-316-NE1 -†- (coil code) 
3-way 3/2	CGS-3331-316-NE1 -†- (coil code) 	CGG-3331-316-NE1 -†- (coil code) 

\*All valves include O ring interface seals and #10-24 mounting screws. For #10-32 screws change NE1 to NE2. For M5 screws change NE1 to NE3.

† Add suffix option here if required.

See coil code page 9.

# SERIES C316 NAMUR Solenoid Options

Area Classification		Suffix Detail	Solenoid Housing Material	Common voltages (Coil Codes) All options available in all voltages, except where noted. Consult factory for other voltages.	NOMINAL COIL POWER AC/DC (watts)
GENERAL	<b>General Purpose</b> 1/2" NPT conduit, NEMA 1, 2, & 3* 1/2" NPT conduit, watertight, NEMA 4 & 4X** Cord grip PG9 mini-DIN type connector, NEMA 4 1/2" NPT conduit, mini-DIN type connector, NEMA 4 * For high temperature coil include -HT	None -PC -HC -HCC	Carbon Steel, Painted Carbon Steel, Electroless nickel plated Engineered polymer Engineered polymer		6.0/7.0 6.0/7.0 6.5/10.5 6.5/10.5
	<b>Hazardous Location UL/CSA (NEMA 7 &amp; 9)</b> Class I, Div 2 (A & B); Class I Div 1 (C & D); Class II Div 1 (E, F & G) 1/2" NPT conduit entry, Basic standard with Low power 1.8W coil with potted coil with Stainless housing coil housing <b>Flameproof (d) - ATEX IECEx</b> EEx II 2 G IIB + H <sub>2</sub> T3 T6* Ex d Ex d IIB T3 to T6 Gb M20 x 1.5 conduit entry, Basic standard with Low power 1.8W coil, T6 with potted coil with Stainless steel coil housing with Flameproof Junction Box <b>Flameproof (d) Increased Safety (e) - ATEX IECEx, CSA, INMETRO</b> EX II 2 G D Ex d e IIC T* Gb EX tb IIC T* °C Db Ex d IIC DIP A21 T6 T4 Class I Div I Grp B, C & D Class I Div II Grp E, F & G with M20 x 1.5 conduit entry with 1/2" NPT conduit entry <b>Encapsulated (m), Increased Safety (e) Tight Dust (tD) - ATEX IECEx</b> EEx II 2 G Ex e mb II T5 & T6 EEx II 2 D Ex d A21 IP66/IP67 T100°C, T85°C Ex e mb II T5, T6 Gb Ex d A21 IP66/IP67 T100°C, T85°C Db M20 x 1.5 Conduit entry with 6-12mm ø cable gland 1/2" NPT conduit entry with 9-16mm ø cable gland <b>Intrinsically Safe FM/CSA</b> Class I (Group A, B, C, D); Class II (Group E, F, G), CLASS III, DIV 1 ** With PG9 cable gland, mini-DIN type connector with 1/2" NPT conduit entry <b>Intrinsically Safe (ia) - ATEX</b> II 2 G EEx ia IIC T4, to T6** With PG9 cable gland, mini-DIN type connector with 1/2" NPT conduit entry <b>Intrinsically Safe (ia) - ATEX</b> II 2 G EEx ia IIC T4, to T6 with M20 x 1.5 conduit entry with 1/2" NPT conduit entry	-XX -LB-XX -PC-XX -ST-XX -XN -LB-XN -PC-XN -ST-XN -AJB-XN -XDBS † -XDBT † -XMAA -XMFA -XMAF -XMFF -HC-XISC -HCC-XISC -HC-XISX6 -HCC-XISX6 -XIFA -XIFF	Carbon Steel, Electroless nickel plated Carbon Steel, Electroless nickel plated Carbon Steel, Electroless nickel plated Stainless Steel Carbon Steel, Electroless nickel plated Carbon Steel, Electroless nickel plated Carbon Steel, Electroless nickel plated Stainless Steel -XN w/Aluminum Epoxy Coated Box Stainless Steel w/ Junction Box Stainless Steel w/ Junction Box Engineered polymer Engineered polymer Engineered polymer Engineered polymer Engineered polymer Engineered polymer Engineered polymer Engineered polymer	12VDC (D012) 24VDC (D024) 48VDC (D048) 120V60 (A120) 110V50 (E110) 240V60 (A240) 220V50 (E220)	5.6/7.2 1.8/1/8 5.6/7.2 5.6/7.2 5.6/7.2 5.6/7.2 0.85, 1.8 & 4 0.85, 1.8 & 4 NA/4.0 NA/4.0 NA/4.0 NA/4.0 NA/1.6 NA/1.6 NA/1.6 NA/1.6 NA/0.8 NA/0.8
MISC	Manual Override, un-guarded push and hold (not available with all solenoid options) Solenoid exhaust adapter, 1/8" NPT Silencer/Dust Excluder for Solenoid Exhaust (not available -XISC or -XISX6)	-ME -H2 -L14		Notes * For high temperature coil add , -HT (included in XMA_, XIF_) ** 24 Volt DC Only †For ordering information see "Miscellaneous" column page 27.	

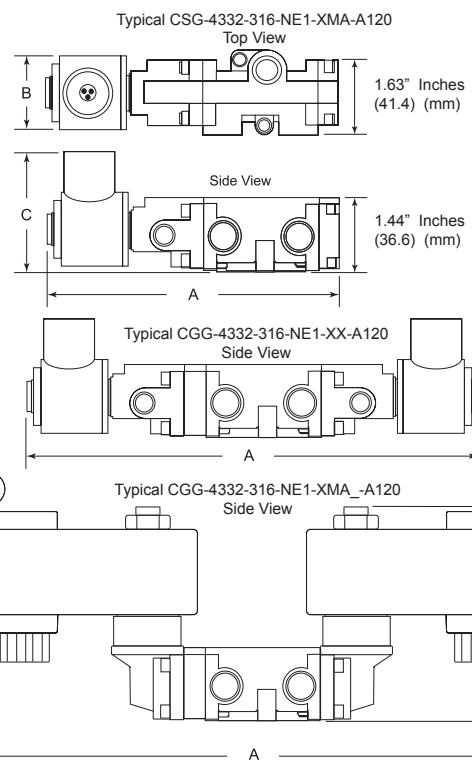

## Dimensions

C316 NAMUR DIMENSIONS		SOLENOID OPTIONS								
		GENERAL SERVICE			HAZARDOUS SERVICE (-XX, -XN, -XISC, -XISX6)			HAZARDOUS SERVICE (-XMA, -XIF)		
Valve Type		A	B	C	A	B	C	A	B	C
Single solenoid, spring return	Inches (mm)	5.62 (142.7)	1.44 (36.6)	2.33 (59.1)	5.67 (144)	1.44 (36.6)	2.33 (59.1)	6.59 (167.3)	2.56 (65)	4.27 (108.5)
Double solenoid	Inches (mm)	8.70 (221)	1.44 (36.6)	2.33 (59.1)	8.79 (223.2)	1.44 (36.6)	2.33 (59.1)	10.6 (269.2)	2.56 (65)	4.27 (108.5)

For warranty information and/or any additional information with regards to installation, operation and service warnings, please consult factory.



# Bodyported Series C5 & C7 Dimensions

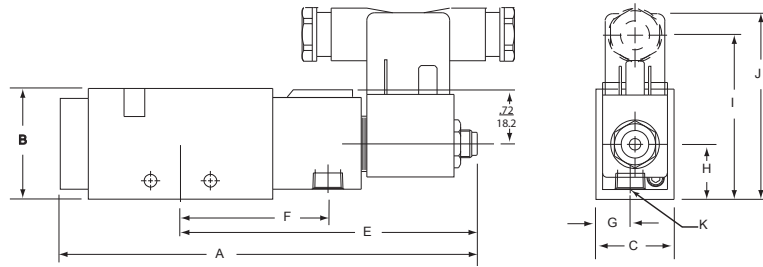

**5/2 SINGLE SOLENOID**

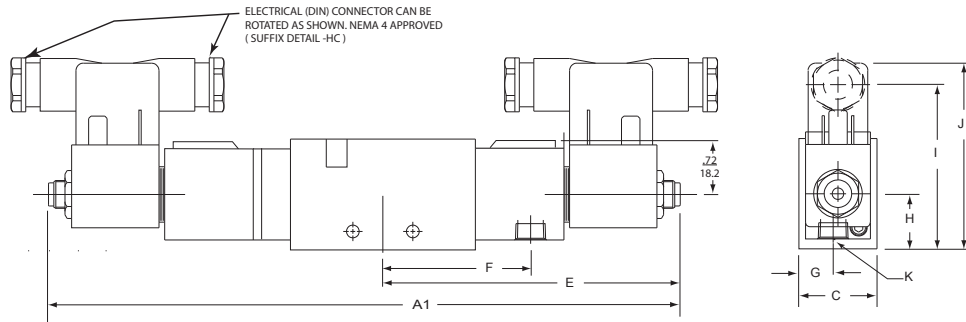

**5/2 & 5/3 DOUBLE SOLENOID**

**Basic Valve Dimensions**

		A	A1	B	C	E	F	G	H	J	K	L
C5	inch	5.03	7.92	1.25	0.88	3.71	1.69	0.38	0.63	2.11	1/8" NPT	2.47
	mm	127.7	201.2	31.8	22.4	94.2	42.8	9.5	15.9	53.5	G1/8	62.8
C7	inch	5.65	8.55	1.50	1.06	4.02	2.00	0.47	0.75	2.23	1/4" NPT	2.52
	mm	143.6	217.1	38.1	27.0	102.2	50.8	11.8	19.1	56.7	G1/4	64.2

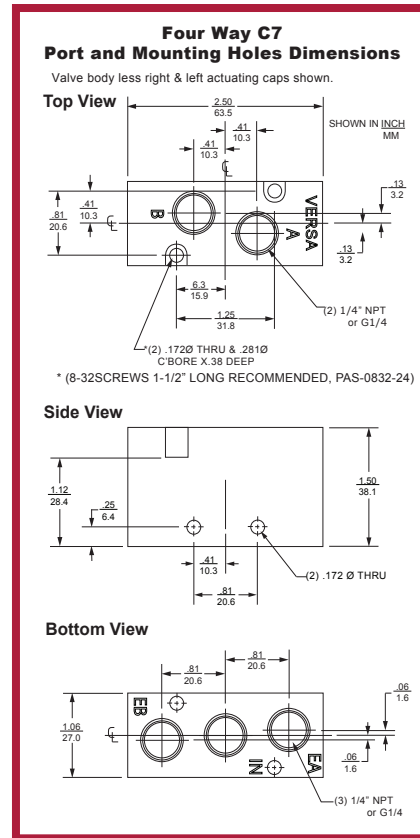
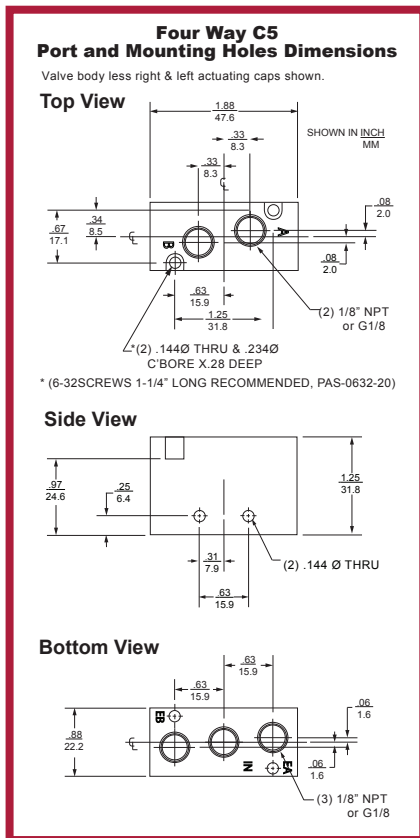

**NOTE:** VALVES SUPPLIED WITH G THREADS HAVE PORTS MARKED AS FOLLOWS: IN=1, A=2, EA=3, B=4, EB=5



# Series V Bodyported Valve Product Number Selector

## BASIC VALVE NUMBER

Function	Port Size (NPT)*	Flow		Single Solenoid/Spring Return 2-position	Double Solenoid/Momentary Contact 2-position	Double Solenoid/Spring Centered 3-position	
		C <sub>v</sub>	(Kv)			Blocked Center	Exhaust Ports Open
3-way, 3/2 Normally Closed	1/8"	1.4	(20.3)	VSG-3221-U-(coil code)	VGG-3221-U-(coil code)	VXX-3223-U-(coil code)	-----
	1/4"	1.8	(26.1)	VSG-3321-U-(coil code)	VGG-3321-U-(coil code)	VXX-3323-U-(coil code)	
	3/8"	3.4	(49.3)	VSG-3421-U-(coil code)	VGG-3421-U-(coil code)	VXX-3423-U-(coil code)	
	1/2"	4.0	(58.0)	VSG-3521-U-(coil code)	VGG-3521-U-(coil code)	VXX-3523-U-(coil code)	
	3/4"	9.7	(140.6)	VSG-3621-U-(coil code)	VGG-3621-U-(coil code)	VXX-3623-U-(coil code)	
3-way, 3/3 Three Position	1"	11.1	(161.0)	VSG-3721-U-(coil code)	VGG-3721-U-(coil code)	VXX-3723-U-(coil code)	
3-way, 3/2 Normally Open	1/8"	1.4	(20.3)	VGS-3222-U-(coil code)	SEE ABOVE	SEE ABOVE	-----
	1/4"	1.8	(26.1)	VGS-3322-U-(coil code)			
	3/8"	3.4	(49.3)	VGS-3422-U-(coil code)			
	1/2"	4.0	(58.0)	VGS-3522-U-(coil code)			
	3/4"	9.7	(140.6)	VGS-3622-U-(coil code)			
3-way, 3/3 Three Position	1"	11.1	(161.0)	VGS-3722-U-(coil code)			
4-way, 5/2 & 5/3	1/8"	1.4	(20.3)	VSG-4222-U-(coil code)	VGG-4222-U-(coil code)	VXX-4223-U-(coil code)	VXX-4224-U-(coil code)
	1/4"	1.8	(26.1)	VSG-4322-U-(coil code)	VGG-4322-U-(coil code)	VXX-4323-U-(coil code)	VXX-4324-U-(coil code)
	3/8"	3.4	(49.3)	VSG-4422-U-(coil code)	VGG-4422-U-(coil code)	VXX-4423-U-(coil code)	VXX-4424-U-(coil code)
	1/2"	4.0	(58.0)	VSG-4522-U-(coil code)	VGG-4522-U-(coil code)	VXX-4523-U-(coil code)	VXX-4524-U-(coil code)
	3/4"	9.7	(140.6)	VSG-4622-U-(coil code)	VGG-4622-U-(coil code)	VXX-4623-U-(coil code)	VXX-4624-U-(coil code)
5/2 & 5/3	1"	11.1	(161.0)	VSG-4722-U-(coil code)	VGG-4722-U-(coil code)	VXX-4723-U-(coil code)	VXX-4724-U-(coil code)

For coil code see page 27.

\* Valves with ISO 228 "G" threads have same Cv (Kv) flow factors as corresponding NPT port sizes. To indicate model number of valves with "G" thread, add suffix "-2B" to basic valve number shown. For example: VSG-3221-U becomes VSG-3221-U-2B.

### SERIES V BODYPORTED SOLENOID OPTIONS

(Consult page number indicated for complete description of desired option.)

Coil & Coil Housing - nonhazardous location

Suffix

- none: Std coil & housing, (page 26/28)
- HT: Class H coil, (page 27, 30)
- HC or -HCC: DIN style coil & connector, (page 28, 30)
- PC: Potted coil, (page 28, 30)

Manual Override

Suffix

- G, -M or -M5R: (page 29)

Seals

Suffix

- 155: FKM (fluorocarbon)

Voltage (coil code) -(page 27).

For other coil voltages consult factory.

Solenoid Operator - nonhazardous location

Suffix

- none: Std coil & housing, (page 26-27, 28)
- HC or -HCC: DIN style coil and connector, (page 26-27, 28)

Solenoid Operator - hazardous location

Suffix

- LB: Low power (1.8 W) operator, (page 26/30)
- PC
- XX
- XN
- AJB-PS-XN
- XDAS, T
- XIFA, E, F
- HC-XISC, -HCC-XISC
- HC-XISX6, -HCC-XISX6
- XMAA, E, F, G
- XMFA, E, F, G

(page 26/30)

Misc - nonhazardous & hazardous

Suffix: -E14 Silencer/Dust Excluder For Solenoid Exhaust

-D14 Water & Dust Excluder / Silencer

(not available for -XISC or -XISX6)

# BODYPORTED VALVES

BRASS CONSTRUCTION

## BODYPORTED SERIES V Dimensions†

### THREE-WAY

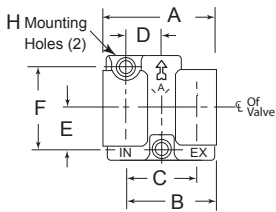

### BODY DETAIL

Basic Valve Dimensions		A		B		C		D		E		F		HØ	
NPT or G	in	mm	in	mm	in	mm	in	mm	in	mm	in	mm	in	mm	
1/8 - 1/4	2 <sup>3</sup> / <sub>16</sub>	56	1 <sup>3</sup> / <sub>4</sub>	44	1 <sup>5</sup> / <sub>16</sub>	33	2 <sup>1</sup> / <sub>32</sub>	17	5 <sup>1</sup> / <sub>64</sub>	20	1 <sup>19</sup> / <sub>32</sub>	40	.256	6.5	
3/8 - 1/2	3 <sup>3</sup> / <sub>4</sub>	95	2 <sup>7</sup> / <sub>8</sub>	73	2	51	1	25	1 <sup>1</sup> / <sub>8</sub>	29	2 <sup>1</sup> / <sub>4</sub>	57	.328	8	
3/4 - 1	5 <sup>1</sup> / <sub>2</sub>	140	4 <sup>1</sup> / <sub>4</sub>	108	3	76	1 <sup>1</sup> / <sub>2</sub>	38	1 <sup>9</sup> / <sub>16</sub>	40	3 <sup>1</sup> / <sub>8</sub>	79	.390	10	

### SINGLE SOLENOID

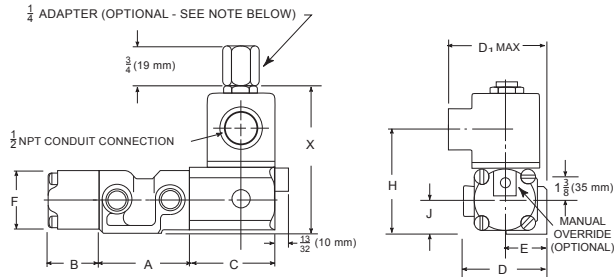

### DOUBLE SOLENOID

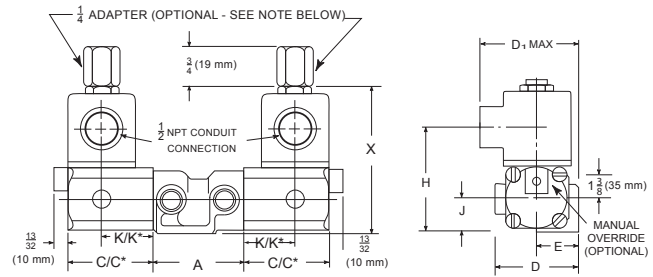

Basic Valve Dimensions		A		B		C		C*		D1		D		E		F		H		J		K		K*		X	
NPT or G	in	mm	in	mm	in	mm	in	mm	in	mm	in	mm	in	mm	in	mm	in	mm	in	mm	in	mm	in	mm	in	mm	
1/8 - 1/4	2 <sup>3</sup> / <sub>16</sub>	56	1 <sup>7</sup> / <sub>32</sub>	31	2 <sup>3</sup> / <sub>32</sub>	53	3	76	2 <sup>1</sup> / <sub>2</sub>	64	2	51	1	25	1 <sup>1</sup> / <sub>2</sub>	38	2 <sup>19</sup> / <sub>32</sub>	66	1 <sup>13</sup> / <sub>16</sub>	21	1 <sup>9</sup> / <sub>32</sub>	33	2 <sup>3</sup> / <sub>16</sub>	56	3 <sup>13</sup> / <sub>16</sub>	97	
3/8 - 1/2	3 <sup>3</sup> / <sub>4</sub>	95	1 <sup>7</sup> / <sub>32</sub>	31	2 <sup>3</sup> / <sub>32</sub>	53	3	76	2 <sup>7</sup> / <sub>8</sub>	73	2 <sup>3</sup> / <sub>4</sub>	70	1 <sup>3</sup> / <sub>8</sub>	35	1 <sup>11</sup> / <sub>16</sub>	43	2 <sup>21</sup> / <sub>32</sub>	67	7 <sup>7</sup> / <sub>8</sub>	22	1 <sup>9</sup> / <sub>32</sub>	33	2 <sup>3</sup> / <sub>16</sub>	56	3 <sup>7</sup> / <sub>8</sub>	98	
3/4 - 1	5 <sup>1</sup> / <sub>2</sub>	140	2 <sup>7</sup> / <sub>16</sub>	52	2	51	3 <sup>19</sup> / <sub>32</sub>	88	3 <sup>3</sup> / <sub>8</sub>	86	3 <sup>3</sup> / <sub>4</sub>	95	1 <sup>7</sup> / <sub>8</sub>	48	2 <sup>7</sup> / <sub>16</sub>	62	3 <sup>29</sup> / <sub>32</sub>	99	1 <sup>1</sup> / <sub>4</sub>	32	1	25	2 <sup>1</sup> / <sub>2</sub>	64	5 <sup>5</sup> / <sub>32</sub>	131	

\*Dimensions for Spring-Centering Valves. NOTE: Adapter is supplied when specified by adding suffix "-H" to product number

### FOUR-WAY

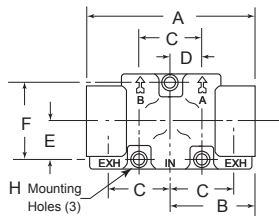

### BODY DETAIL

Basic Valve Dimensions		A		B		C		D		E		F		HØ	
NPT or G	in	mm	in	mm	in	mm	in	mm	in	mm	in	mm	in	mm	
1/8 - 1/4	3 <sup>1</sup> / <sub>2</sub>	89	1 <sup>3</sup> / <sub>4</sub>	44	1 <sup>5</sup> / <sub>16</sub>	33	2 <sup>1</sup> / <sub>32</sub>	17	5 <sup>1</sup> / <sub>64</sub>	20	1 <sup>19</sup> / <sub>32</sub>	40	.256	6.5	
3/8 - 1/2	5 <sup>3</sup> / <sub>4</sub>	146	2 <sup>7</sup> / <sub>8</sub>	73	2	51	1	25	1 <sup>1</sup> / <sub>8</sub>	29	2 <sup>1</sup> / <sub>4</sub>	57	.328	8	
3/4 - 1	8 <sup>1</sup> / <sub>2</sub>	216	4 <sup>1</sup> / <sub>4</sub>	108	3	76	1 <sup>1</sup> / <sub>2</sub>	38	1 <sup>9</sup> / <sub>16</sub>	40	3 <sup>1</sup> / <sub>8</sub>	79	.390	10	

### SINGLE SOLENOID

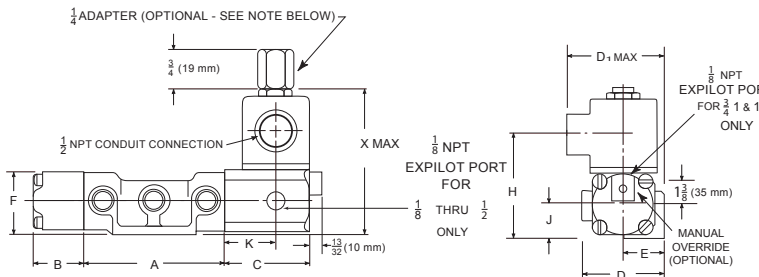

### DOUBLE SOLENOID

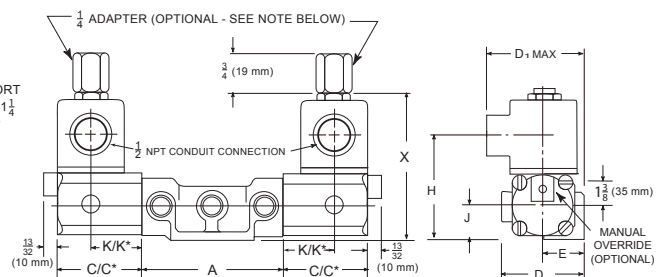

Basic Valve Dimensions		A		B		C		C*		D1		D		E		F		H		J		K		K*		X	
NPT or G	in	mm	in	mm	in	mm	in	mm	in	mm	in	mm	in	mm	in	mm	in	mm	in	mm	in	mm	in	mm	in	mm	
1/8 - 1/4	3 <sup>1</sup> / <sub>2</sub>	89	1 <sup>7</sup> / <sub>32</sub>	31	2 <sup>3</sup> / <sub>32</sub>	53	3	76	2 <sup>1</sup> / <sub>2</sub>	64	2	51	1	25	1 <sup>1</sup> / <sub>2</sub>	38	2 <sup>19</sup> / <sub>32</sub>	66	1 <sup>13</sup> / <sub>16</sub>	21	1 <sup>9</sup> / <sub>32</sub>	33	2 <sup>3</sup> / <sub>16</sub>	56	3 <sup>13</sup> / <sub>16</sub>	97	
3/8 - 1/2	5 <sup>3</sup> / <sub>4</sub>	146	1 <sup>7</sup> / <sub>32</sub>	31	2 <sup>3</sup> / <sub>32</sub>	53	3	76	2 <sup>7</sup> / <sub>8</sub>	73	2 <sup>3</sup> / <sub>4</sub>	70	1 <sup>3</sup> / <sub>8</sub>	35	1 <sup>11</sup> / <sub>16</sub>	43	2 <sup>21</sup> / <sub>32</sub>	67	7 <sup>7</sup> / <sub>8</sub>	22	1 <sup>9</sup> / <sub>32</sub>	33	2 <sup>3</sup> / <sub>16</sub>	56	3 <sup>7</sup> / <sub>8</sub>	98	
3/4 - 1	8 <sup>1</sup> / <sub>2</sub>	216	2 <sup>7</sup> / <sub>16</sub>	52	2	51	3 <sup>19</sup> / <sub>32</sub>	88	3 <sup>3</sup> / <sub>8</sub>	86	3 <sup>3</sup> / <sub>4</sub>	95	1 <sup>7</sup> / <sub>8</sub>	48	2 <sup>7</sup> / <sub>16</sub>	62	3 <sup>29</sup> / <sub>32</sub>	99	1 <sup>1</sup> / <sub>4</sub>	32	1	25	2 <sup>1</sup> / <sub>2</sub>	64	5 <sup>5</sup> / <sub>32</sub>	131	

\*Dimensions for Spring-Centering Valves. NOTE: Adapter is supplied when specified by adding suffix "-H" to product number

†Dimensions shown are for basic valve as listed on previous page. Some options may change the dimensions, for which consult factory.

# 3-WAY DIRECT SOLENOID VALVES

### General Description

Two valve series, Series E and Series E5, comprise the direct actuated, 3 port/2 position valves. The main difference between the two series is physical size and weight, Series E being the greater of the two. Both series offer high reliability at low cost. Stainless steel construction provides the compatibility for use with many aggressive media and environments.

A variation of the valve type provides electrical quick exhaust valves. These valves function the same as a 3-way valve, but a larger capacity exhaust and rapid response to slight pressure differential during the de-energized portion of the cycle, results in a more rapid evacuation of the controlled device than would be expected with a standard 3-way valve.

### Materials

Valve body, 430F stainless steel  
 Valve seals: Nitrile (Buna N)  
 Solenoid parts: sleeve, plunger & spring— 304, 430F and 302 stainless steel  
 coils—epoxy molded  
 coil cover (when applicable)—zinc chromate coated steel

### Installation, Filtration and Lubrication

Valves have no limitations on mounting orientation.  
 40 to 50 micron filtration and general purpose lubricating oil ISO, ASTM viscosity grade 32 recommended.  
 Ambient temperature range 0°F (-18°C) to 180°F (82°C).

### 3-WAY DIRECT SOLENOID VALVE PRODUCT NUMBER SELECTOR

### BASIC VALVE NUMBER Single Solenoid/Spring Return, 2 Position

Function	Maximum Operating Pressure Differential†	Series			Flow Cv (Kv)	
		1/8" NPT	1/4" NPT	Series E5 1/8" NPT	Inlet	Exhaust
3-Way, 3/2 Normally Closed Exhaust to Atmosphere (For Piped Exhaust add -H to ESM and -H2 to E5SM valve number)	150 psi (10.0 bar)	ESM-3201-34-*	ESM-3301-34-*	E5SM-3201-34-*	.06 (.87)	.106 (1.5)
	100 psi (6.9 bar)	ESM-3201-44-*	ESM-3301-44-*	E5SM-3201-44-*	.106 (1.5)	.106 (1.5)
	75 psi (5.2 bar)	ESM-3201-66-*	ESM-3301-66-*	-----	.21 (3.1)	.21 (3.1)
	60 psi (4.1 bar)	-----	-----	E5SM-3201-64	.21 (3.1)	.106 (1.5)
	50 psi (3.4 bar)	ESM-3201-86-*	ESM-3301-86-*	-----	.26 (3.8)	.21 (3.1)
	30 psi (2.1 bar)	-----	-----	E5SM-3201-84-*	.26 (3.8)	.106 (1.5)
20 psi (1.4 bar)	ESM-3201-126-*	ESM-3301-126-*	-----	.56 (8.1)	.21 (3.1)	
Vacuum (AC only)	ESM-3201-166-*	ESM-3301-166-*	-----	.79 (11.5)	.21 (3.1)	
3-Way, 3/2 Normally Open Piped Exhaust	150 psi (10.0 bar)	ESM-3202-43-H-*	ESM-3302-43-H-*	-----	.06 (.87)	.106 (1.5)
	125 psi (8.6 bar)	-----	-----	E5SM-3202-33-H2-*	.06 (.87)	.06 (8.7)
	100 psi (6.9 bar)	ESM-3202-44-H-*	ESM-3302-44-H-*	-----	.106 (1.5)	.106 (1.5)
	100 psi (6.9 bar)	ESM-3202-84-H-*	ESM-3302-84-H-*	-----	.106 (1.5)	.26 (3.8)
	100 psi AC only (6.9 bar)	-----	-----	E5SM-3202-44-H2-*	.106 (1.5)	.106 (1.5)
	75 psi (5.2 bar)	ESM-3202-66-H-*	ESM-3302-66-H-*	-----	.21 (3.1)	.21 (3.1)
75 psi (5.2 bar)	ESM-3202-86-H-*	ESM-3302-86-H-*	-----	.21 (3.1)	.26 (3.8)	
75 psi DC only (5.2 bar)	-----	-----	E5SM-3202-44-H2-*	106 (1.5)	.106 (1.5)	
3-Way, 3/2 Normally Closed QUICK EXHAUST	Operating Pressure†	1/4" NPT Inlet & Outlet 3/4" NPT Exhaust		1/4" NPT Inlet & Outlet 3/8" NPT Exhaust		
	5-150 psi (0.3-10 bar)	EQE-50403-316-*		-----		.06 (.87) 8.8 (128)
	5-150 psi (0.3-10 bar)	-----		E5QE-30303-316-*		.055 (.80) 3.3 (48)
	5-100 psi (0.3-6.9 bar)	EQE-50604-316-*		-----		.106 (1.5) 8.8 (128)
5-100 psi (0.3-6.9 bar)	-----		E5QE-30404-316-*		.075 (1.1) 3.3 (48)	

† MPa =  $\frac{\text{bar}}{10}$  \* Add coil code to valve number (page 27).

### 3-WAY DIRECT SOLENOID OPTIONS (Consult page number indicated for complete description of desired option.)

Series E Suffix	<b>SOLENOID OPERATOR (nonhazardous location)</b>	Series E5 Suffix
-HC or _HCC	DIN style coil & connector, (page 26/27, 28)	-HC or -HCC
-PC	Potted coil, (page 26/27, 28)	-PC
-----	<b>SOLENOID OPERATOR - (hazardous location)</b>	
-XDBS* or T* -XX -XX	Flameproof (page 26/27 & 29)	-LB-XX; -LB-XN -XX -XN -AJB-PS-XN -PC-XX
-PS-XX		
-XMAA, E, F or G -XMFA, E, F or G	Encapsulation (page 26/27 & 29)	-----
-XIFA, F		-HC-XISC, -HCC-XISC -HC-XISX6, -HCC-XISX6
	<b>MISCELLANEOUS</b>	
-3	FKM (fluorocarbon) seals	-3
-HT	Class H coil (page 29, 30)	-HT
-M-,M5R,-MAE	Manual Override (page 29)	-----
-E14	Silencer/Dust Excluder for Solenoid Exhaust	-L14

### DIMENSIONS inches FOR BASIC VALVE mm

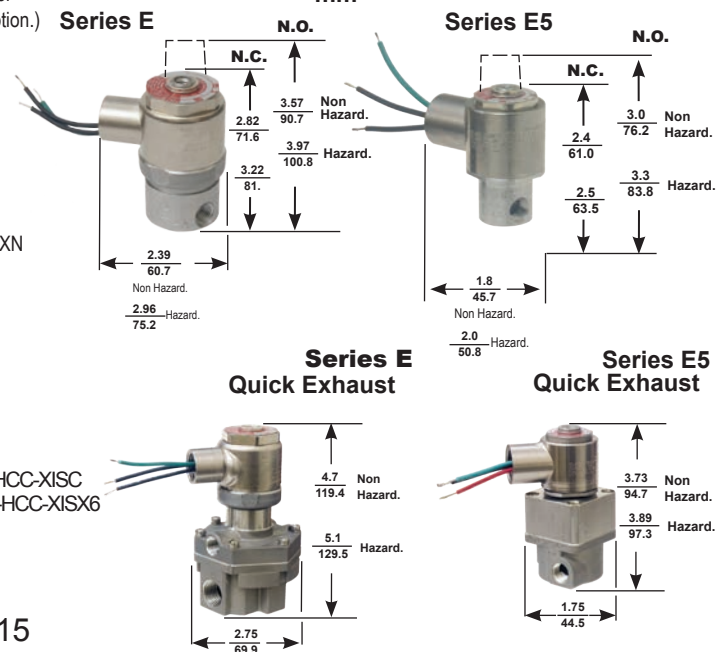

# BODYPORTED VALVES

STAINLESS STEEL CONSTRUCTION

## SERIES C316 Bodyported 3-Way & 4-Way Solenoid Valves

### General Description

Versa Series C316 stainless steel valve is a high flow, 3 or 5 port solenoid valve that utilizes a fluorocarbon elastomer seal packed plunger that provides bubbletight performance with long, trouble-free product life. The design also provides the highest flow in the smallest package. Stainless steel bodies, actuating caps and internal parts allow use in the most aggressive environments.

The C316 Series is available as 4-Way, for double acting devices, or 3-Way for spring return devices. The 3-Way function can be specified as either normally open or normally closed. All solenoid actuators are solenoid/pilot type, which allows the use of small solenoids resulting in low power consumption. Solenoid/pilots also provide a positive shifting force that assures the valve shifts, thus reducing the chance of coil burnout. Single solenoid-spring return models utilize an air assisted return feature assuring a positive return. Double solenoid models are equipped with a detent that maintains the valve in the last shifted position, even in high vibration environments. A complete selection of electrical connections, power requirements and area classifications makes the Versa C316 the valve of choice for demanding applications.

A Latching Reset option for single solenoid-spring return 3-Way & 4-Way valves is available for the C316 Series. With the loss of solenoid signal or pressure, the valve shifts closed and latches. The valve cannot be re-shifted until manually reset.

### Materials

Valve body, actuating caps & internal parts: 316L stainless steel  
 Valve seals: FKM (fluorocarbon)  
 Screws: stainless steel  
 Solenoid internal parts: 304, 430F & 302 stainless steel  
 Coil/solenoid housing: per solenoid option selected

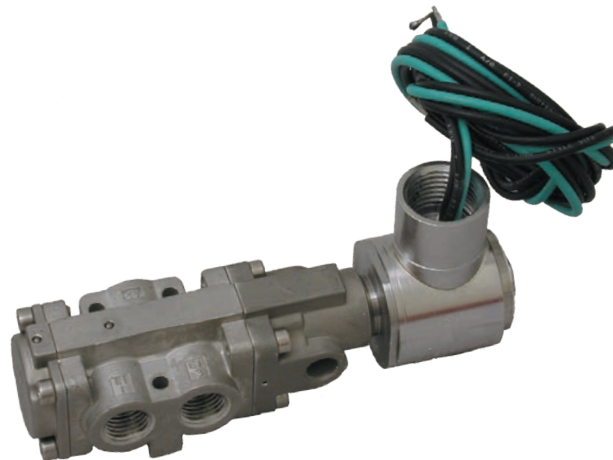

### Operating Pressures & Weights

Valve Type	Operating Pressure Range Pneumatic	General Service	Hazardous Service (-XX, -XN, -XIS)	Hazardous Service (-XMA, -XIF)
Single Solenoid-Spring Return	25 to 150 psi (1.8 to 10.3 bar)	1.3 lbs (590 gms)*	1.6 lbs (725 gms)*	2.5 lbs (1130 gms)*
Single Solenoid-Latching 3-Way	25 to 150 psi (1.8 to 10.3 bar)	1.6 lbs (725 gms)*	1.9 lbs (860 gms)*	2.8 lbs (1270 gms)*
Double Solenoid-Detented	15 to 150 psi (1.0 to 10.3 bar)	1.9 lbs (860 gms)*	2.6 lbs (1180 gms)*	4.3 lbs (1950 gms)*

\*Weights shown are for 3-Way valves. For 4-Way add 0.1 lbs (45 gms).

### Porting Sizes

Inlet cylinder & exhaust: 1/4 NPT

### Installation, Filtration and Lubrication

Valves have no limit on mounting orientation.

40 to 50 micron filtration is recommended

Lubrication not required

Ambient & media temperature range -5°F to 200°F (-20°C to 93°C)

### Flow Rate

Cv = 2.0 (Kv = 29.3)

### Options

See page 17

### Series C316 BODYPORTED VALVE Product Number Selector

Basic Valve Number			
FUNCTION	SINGLE SOLENOID/SPRING RETURN, 2 POSITION	DOUBLE SOLENOID DETENT, 2 POSITION	LATCHING, SINGLE SOLENOID SPRING RETURN
4-Way 5/2	CSG-4322-316-†-(coil code) 	CGG-4322-316-†-(coil code) 	CAG-4322-316-356BN-†-(coil code) 
3-Way NC 3/2	CSG-3321-316-†-(coil code) 	CGG-3321-316-†-(coil code) 	CAG-3321-316-356BN-†-(coil code) 
3-Way NO 3/2	CGS-3322-316-†-(coil code) 	CGG-3321-316-†-(coil code) 	CGA-3322-316-356BN-†-(coil code) 

† Add suffix option here as required. See coil code below.

# Series C316 Bodyported Solenoid Options

		Suffix Detail	Solenoid Housing Material	Voltages (Coil Codes) All options available in all voltages, except where noted. Consult factory for other voltages.	NOMINAL COIL POWER AC/DC (watts)
GENERAL	<b>General Purpose</b>	None -PC -HC -HCC	Carbon Steel, Painted Carbon Steel, Electroless nickel plated Engineered polymer Engineered polymer		6.0/7.0 6.0/7.0 6.5/10.5 6.5/10.5
	<p>1/2" NPT conduit, NEMA 1, 2, &amp; 3*</p> <p>1/2" NPT conduit, watertight, NEMA 4 &amp; 4X**</p> <p>Cord grip PG9 mini-DIN type connector, NEMA 4</p> <p>1/2" NPT conduit, mini-DIN type connector, NEMA 4</p> <p>* For high temperature coil include -HT</p>				
HAZARDOUS	<b>Hazardous Location UL/CSA (NEMA 7 &amp; 9)</b>	-XX -LB-XX -PC-XX -ST-XX	Carbon Steel, Electroless nickel plated Carbon Steel, Electroless nickel plated Carbon Steel, Electroless nickel plated Stainless Steel		5.6/7.2 1.8/1/8 5.6/7.2 5.6/7.2
	<p>Class I, Div 2 (A &amp; B); Class I Div 1 (C &amp; D); Class II Div 1 (E, F &amp; G)</p> <p>1/2" NPT conduit entry, Basic standard with Low power 1.8W coil, T6 with potted coil with Stainless housing coil housing</p> <p><b>Flameproof (d) - ATEX IECEX</b></p> <p>EEx II 2 G IIB + H<sub>2</sub> T3 T6*</p> <p>Ex d Ex d IIB T3 to T6 Gb</p> <p>M20 x 1.5 conduit entry, Basic standard with Low power 1.8W coil, T6 with potted coil with Stainless steel coil housing with Flameproof Junction Box</p> <p><b>Flameproof (d) Increased Safety (e) - ATEX IECEX, CSA, INMETRO</b></p> <p>EX II 2 G D, Ex d e IIC T* Gb EX tb IIC T* °C Db EXd IIC DIP A21 T6 T4 Class I Div I Grp B, C &amp; D Class I Div II Grp E, F &amp; G</p> <p>with M20 x 1.5 conduit entry with 1/2" NPT conduit entry</p> <p><b>Encapsulated (m), Increased Safety (e) Tight Dust (tD) - ATEX IECEX</b></p> <p>EEx II 2 G Ex e mb II T5 &amp; T6 EEx II 2 D Ex d A21 IP66/IP67 T100°C, T85°C Ex e mb II T5, T6 Gb Ex d A21 IP66/IP67 T100°C, T85°C Db</p> <p>M20 x 1.5 Conduit entry† with 6-12mm ø cable gland† 1/2" NPT conduit entry† with 9-16mm ø cable gland†</p>	-XN -LB-XN -PC-XN -ST-XN -AJB-XN	Carbon Steel, Electroless nickel plated Carbon Steel, Electroless nickel plated Carbon Steel, Electroless nickel plated Stainless Steel -XN w/Aluminum Epoxy Coated Box	<p>12VDC (D012) 24VDC (D024) 48VDC (D048)</p> <p>120V60 (A120) 110V50 (E110) 220V50 (E220) 240V60 (A240)</p>	5.6/7.2 1.8/1/8 5.6/7.2 5.6/7.2
LOCATION	<b>Intrinsically Safe FM/CSA</b>	-XDBS† -XDBT†	Stainless Steel w/ Junction Box Stainless Steel w/ Junction Box		0.85, 1.8 & 4 0.85, 1.8 & 4
	<p>Class I (Group A, B, C, D); Class II (Group E, F, G), CLASS III, DIV 1 **</p> <p>With PG9 cable gland, mini-DIN type connector with 1/2" NPT conduit entry</p> <p>Intrinsically Safe (ia) - ATEX</p> <p>II 2 G EEx ia IIC T4, to T6**</p> <p>With PG9 cable gland, mini-DIN type connector with 1/2" NPT conduit entry</p> <p>Intrinsically Safe (ia) - ATEX</p> <p>II 2 G EEx ia IIC T4, to T6</p> <p>with M20 x 1.5 conduit entry with 1/2" NPT conduit entry</p>	-XMAA -XMFA -XMAF -XMFF	Engineered polymer Engineered polymer Engineered polymer Engineered polymer		NA/4.0 NA/4.0 NA/4.0 NA/4.0
MISC	<b>Intrinsically Safe FM/CSA</b>	-HC-XISC -HCC-XISC	Engineered polymer Engineered polymer		NA/1.6 NA/1.6
	<p>Manual Override, un-guarded push and hold (not available with all solenoid options)</p> <p>Solenoid exhaust adapter, 1/8 NPT</p> <p>Silencer/Dust Excluder for Solenoid Exhaust (not available -XISC or -XISX6)</p>	-HC-XISX6 -HCC-XISX6	Engineered polymer Engineered polymer		NA/1.6 NA/1.6
		-XIFA -XIFF	Engineered polymer Engineered polymer		NA/0.8 NA/0.8

**Notes**  
 \* For high temperature coil add , -HT (included in XMA\_, XIF\_)  
 \*\* 24 Volt DC Only  
 †For ordering information see "Miscellaneous" column page 27.

## Dimensions

VALVE TYPE	SOLENOID OPTIONS									
		GENERAL SERVICE			HAZARDOUS SERVICE (-XX, -XN, -XISC, -XISX6)			HAZARDOUS SERVICE (-XMA_, -XIF_)		
		A	B	C	A	B	C	A	B	C
3-Way Single Solenoid, Spring Return †	Inches (mm)	5.31 (135.0)	1.04 (26.4)	2.13 (54.2)	5.41 (137.5)	1.44 (36.6)	2.30 (58.5)	6.31 (160.3)	2.56 (65)	4.13 (104.8)
4-Way Single Solenoid, Spring Return †	Inches (mm)	5.81 (147.7)	1.04 (26.4)	2.13 (54.2)	5.91 (150.2)	1.44 (36.6)	2.30 (58.5)	6.81 (173.0)	2.56 (65)	4.13 (104.8)
3-Way Double Solenoid, Detented †	Inches (mm)	8.33 (211.6)	1.04 (26.4)	2.13 (54.2)	8.53 (216.8)	1.44 (36.6)	2.30 (58.5)	10.33 (262.4)	2.56 (65)	4.13 (104.8)
4-Way Double Solenoid, Detented †	Inches (mm)	8.83 (221.3)	1.04 (26.4)	2.13 (54.2)	9.03 (229.5)	1.44 (36.6)	2.30 (58.5)	10.83 (275.0)	2.56 (65)	4.13 (104.8)
3-Way Double Solenoid, Latching*	Inches (mm)	6.41 (162.9)	1.04 (26.4)	2.34 (59.4)	6.51 (165.5)	1.44 (36.6)	2.34 (59.4)	7.41 (188.2)	2.56 (65)	4.13 (104.8)

\* Add 0.5" (12.7 mm) to "A" dimension for 4-Way Latch Valve. † For dimensions -XDA\_ & XDB\_ consult factory

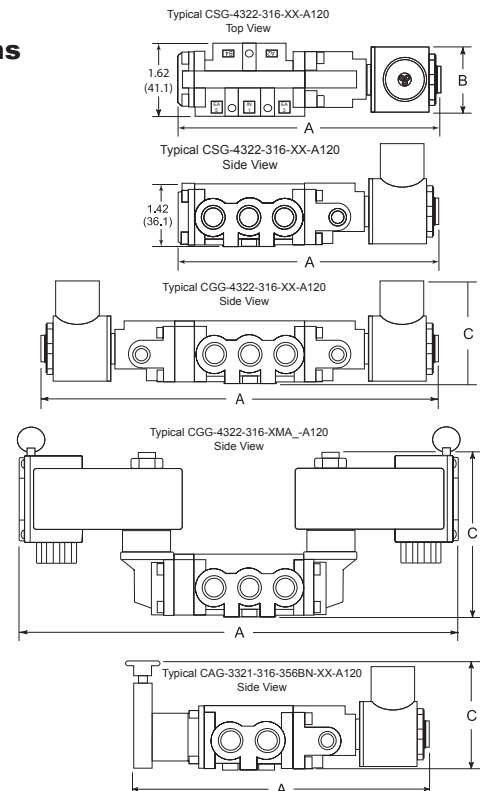

# BODYPORTED VALVES

STAINLESS STEEL CONSTRUCTION

## SERIES V316 Bodyported 3-Way and 4-Way Solenoid Valves

### General Description

Versa Series V316 valves are available in 1/4", 3/8", or 1/2" and 1" NPT port sizes. Three-way designs are provided with 3 ports; four-way valve 5 ports. Each is available for 2-position or 3-position service.

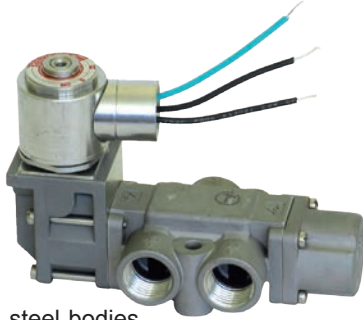

Investment cast 316 stainless steel bodies and actuating caps, coupled with 316 stainless steel internals makes this valve series compatible for use with aggressive media and environments.

Each valve is solenoid/pilot actuated, which enables the use of physically small solenoids and resultant low power consumption, and also assures a large positive shifting force without fear of coil burnout. A complete selection of electrical connections, area classifications, and power requirements makes the most exacting and demanding specifications or applications easy to satisfy.

### Materials

Valve Body, actuating caps, internal parts: 316 stainless steel  
Valve Seals: FKM (fluorocarbon)

Screws: stainless steel

Solenoid Parts: sleeve, plunger & spring – 304, 430F and 302 stainless steel

coils—epoxy molded

coil cover (when applicable) – electroless nickel plated steel

### Porting Sizes

Inlet, outlet, & exhaust: 1/4" NPT, 3/8" NPT, 1/2" or 1" NPT

### Flow Rates (average for all ports)

1/4" NPT:  $C_v = 1.8$  ( $K_v = 26$ )

3/8" NPT:  $C_v = 2.0$  ( $K_v = 29$ )

1/2" NPT:  $C_v = 5.5$  ( $K_v = 80$ )

1" NPT:  $C_v = 11.1$  ( $K_v = 161$ )

### Operating Pressures and Weights

Valve Type	Port Size	Operating Pressure Range <sup>†</sup> Pneumatic	Approximate Weights							
			Ordinary Service				Hazardous Service <sup>††</sup>			
			3-way		4-way		3-way		4-way	
			lbs.	kg	lbs.	kg	lbs.	kg	lbs.	kg
Single Solenoid/spring return (2-position)	1/4" & 3/8" & 1/2" NPT	40 - 175 psi (2.8 - 12 bar)	2.5 3.4	1.2 1.6	2.8 3.2	1.3 1.5	2.7 3.6	1.2 1.6	3.2 3.6	1.5 1.6
	1" NPT	50 - 175 psi (3.5 - 12 bar)	8.4	3.8	—	—	8.6	3.9	—	—
Double Solenoid/momentary contact (2-position)	1/4" & 3/8" & 1/2" NPT	20 - 175 psi (1.4-12 bar)	3.4 4.3	1.6 2.0	3.9 4.3	1.8 2.0	3.8 4.7	1.7 2.1	4.3 4.7	2.0 2.1
	1" NPT	20 - 175 psi (1.4 - 12 bar)	9.2	4.2	—	—	9.6	4.4	—	—
Double Solenoid/spring centered (3-position)	1/4" & 3/8" NPT	40-175 psi (2.8-12 bar)	3.5	1.6	4.0	1.8	3.9	1.8	4.4	2.0
	1/2" NPT		5.0	2.3	5.0	2.3	5.4	2.5	5.4	2.5

<sup>†</sup> Pressure range may change based on solenoid options. See page 27.

$$\text{MPa} = \frac{\text{bar}}{10}$$

<sup>††</sup> Weights shown for hazardous service are for -XX type. For other suffix options consult factory.

### Installation, Filtration and Lubrication

Valves have no limitations on mounting orientation.  
40 to 50 micron filtration and general purpose lubricating oil ISO, ASTM viscosity grade 32 recommended.  
Ambient temperature range -10°F (-23°C) to 200°F (95°C).

## Series V316 Bodyported Valve Product Number Selector

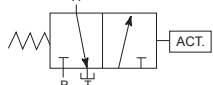
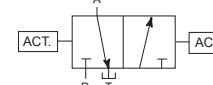
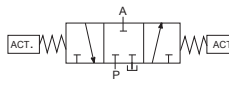
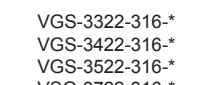
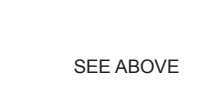
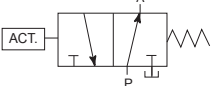
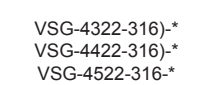
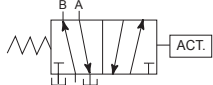
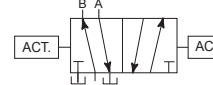
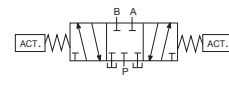
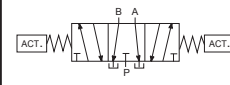
BASIC VALVE NUMBER							
Function	Port Size (NPT)*	Flow		Single Solenoid/Spring Return, 2-position	Double Solenoid/Momentary Contact 2-position	Double Solenoid/Spring Centered 3-position	
		Cv	(Kv)			Blocked Center	Exhaust Ports Open
3-Way, 3/2 Normally Closed	1/4"	1.8	(26)	VSG-3321-316-* VSG-3421-316-* VSG-3521-316-* VSG-3721-316-* 	VGG-3321-316-* VGG-3421-316-* VGG-3521-316-* VGG-3721-316-* 		-----
	3/8"	2.0	(29)				
3-Way, 3/3 Three Position	1/2"	5.5	(80)			VXX-3323-316-* VXX-3423-316-* VXX-3523-316-*	-----
	1"	11.1	(161)				
	1/4"	1.8	(26)				
3-Way, 3/2 Normally Open	3/8"	2.0	(29)	VGS-3322-316-* VGS-3422-316-* VGS-3522-316-* VSG-3722-316-* 	SEE ABOVE	-----	-----
	1/2"	5.5	(80)				
	1"	11.1	(161)				
3-Way, 3/3 Three Position	1/4"	1.8	(26)		-----	SEE ABOVE	-----
	3/8"	2.0	(29)				
	1/2"	5.5	(80)				
4-Way, 5/2 & 5/3	1/4"	1.8	(26)	VSG-4322-316-* VSG-4422-316-* VSG-4522-316-* 	VGG-4322-316-* VGG-4422-316-* VGG-4522-316-* 	VXX-4323-316-* VXX-4423-316-* VXX-4523-316-* 	VXX-4324-316-* VXX-4424-316-* VXX-4524-316-* 
	3/8"	2.0	(29)				
	1/2"	5.5	(80)				

\* Add coil code to valve number (page 27).

### SERIES V316 BODYPORTED SOLENOID OPTIONS

(Consult page number indicated for complete description of desired option)

Coil & Coil Housing nonhazardous location

Suffix

- none: Std coil & housing, (page 26/27, 28)
- HT: Class H coil, (page 29, 30)
- HC or -HCC: DIN style coil & connector, (page 26/27, 30)
- PC: Potted coil, (Page 30)

Solenoid Operator nonhazardous location

Suffix

- none: Std coil & housing, (page 26/27, 28)
- HC or -HCC: DIN style coil and connector, (page 26/28)

Manual Override

Suffix

- ME: Manual override (page 29)

Solenoid Operator - hazardous location

Suffix

- ST: Stainless steel coil cover (Page 30)
- LB-XX; -LB-XN Low power (1.8 W) operator, (page 26/30)
- XX
- PC-XX; -PC-XN
- XN
- AJB-PS-XN
- XDAS, T
- XIFA, F
- HC-XISC, -HCC-XISC
- HC-XISX6, -HCC-XISX6
- XMAA, E, F, G
- XMFA, E, F, G

Misc

Suffix

- L14: Silencer/Dust Excluder for Solenoid Exhaust (not available for -XISC or -XISX6)
- D14: Water & Dust Excluder / Silencer

(page 26/30)

Voltage (coil code) - Nonhazardous location operators - (page 27)  
 Hazardous Location operators - (Page 26/29)  
 For other coil voltages consult factor.

# BODYPORTED VALVES

STAINLESS STEEL CONSTRUCTION

## BODYPORTED SERIES V316 Dimensions†

### THREE-WAY

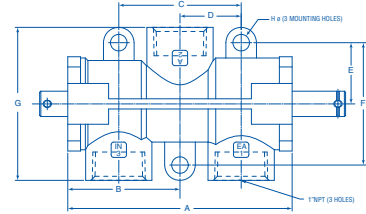
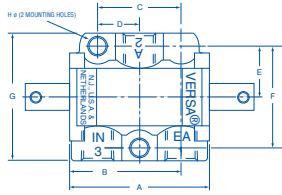

#### BODY DETAIL

SIZE	A		B		C		D		E		F		G		H Ø	
	in	mm	in	mm	in	mm	in	mm	in	mm	in	mm	in	mm	in	mm
1/4" - 3/8"	2.19	56	1.75	45	1.31	33	0.66	17	.80	20	1.59	40	2	51	0.27	6.7
1/2"	2.84	95	2.08	52.8	1.31	33	0.66	17	.80	20	1.59	40	2.5	63.5	0.27	6.7
1"	5.5	140	3.25	82.6	3.0	76	1.5	38.1	1.5	40	3.0	6.2	3.38	85.7	0.4	1.2

### SINGLE SOLENOID

### DOUBLE SOLENOID

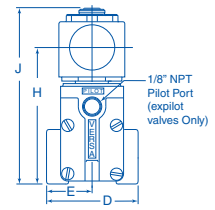
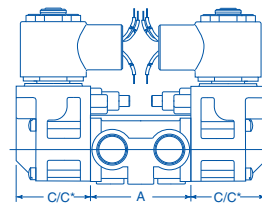
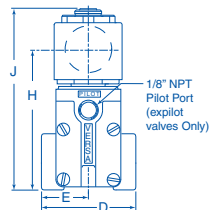
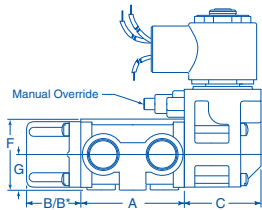

BASIC VALVE DIMENSIONS

SIZE	A		B		B*		C		C*		D		E		F		G		H		J	
	in	mm	in	mm	in	mm	in	mm	in	mm	in	mm	in	mm	in	mm	in	mm	in	mm	in	mm
1/4" - 3/8"	2.19	55.6	1.15	29.2	1.76	45.1	1.62	41.3	2.54	64.6	2	51	1.0	25.4	3.89	97.4	0.75	19.1	3.83	97.4	2.98	75.7
1/2"	2.84	72.1	1.15	29.2	1.76	45.1	1.62	41.3	2.54	64.6	2.5	63.5	1.25	31.8	3.89	97.4	0.75	19.1	3.83	97.4	2.98	75.7
1"	5.5	139.7	2.01	151	—	—	2.01	151	—	—	3.75	95.3	1.88	47.6	5.17	131.3	4.29	109	5.17	131.3	4.29	109

\*Dimensions for Spring-Centering Valves. NOTE: Adapter is supplied when specified by adding suffix "-H2" to product number.

### FOUR-WAY

#### BODY DETAIL

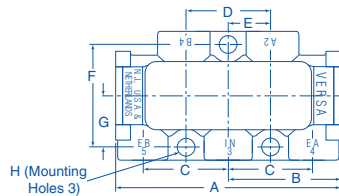

SIZE	A		B		C		D		E		F		G	
	in	mm	in	mm	in	mm	in	mm	in	mm	in	mm	in	mm
1/4" - 3/8"	3.5	89	1.75	44.5	1.31	33.3	1.32	33.5	0.66	16.7	1.56	39.6	0.80	20.2
1/2"	4.0	101.6	2.0	51	1.31	33.3	1.32	33.5	0.66	16.7	1.56	39.6	0.80	20.2

### SINGLE SOLENOID

### DOUBLE SOLENOID

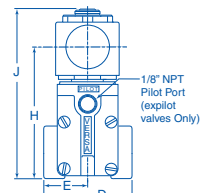
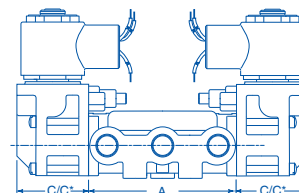
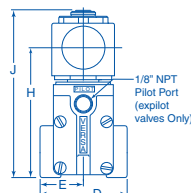
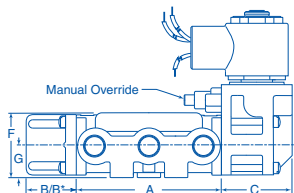

SIZE	A		B		B*		C		C*		D		E		F		G		H		J	
	in	mm	in	mm	in	mm	in	mm	in	mm	in	mm	in	mm	in	mm	in	mm	in	mm	in	mm
1/4" - 3/8"	3.50	88.9	1.15	29.2	1.84	47	1.62	41.3	2.54	64.6	2	51	1.0	25.4	1.56	39.6	0.75	19	2.98	75.7	3.83	97.4
1/2"	4.0	101.6	1.15	29.2	1.84	47	1.62	41.3	2.54	64.6	2.5	63.5	1.25	31.8	1.56	39.6	0.75	19	2.98	75.7	3.83	97.4

\*Dimensions for Spring-Centering Valves. NOTE: Adapter is supplied when specified by adding suffix "-H2" to product number.

†Dimensions shown are for basic valve as listed on previous page. Some options may change the dimensions, for which consult factory.

# LOCKOUT VALVES



BRASS OR STAINLESS STEEL CONSTRUCTION

## 3-Way NC Solenoid Operated/Spring Return Lockout Valves

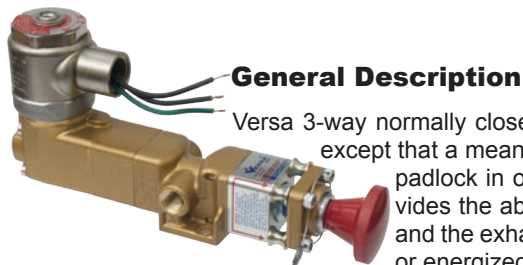

### General Description

Versa 3-way normally closed Lockout Valves function the same as a solenoid operated-spring return valve, except that a means is provided to allow the valve to be physically locked with a padlock or hasp with padlock in order to prevent accidental actuation. Two types of lockout are available: one provides the ability for locking the valve in the de-energized position whereby the inlet is blocked and the exhaust is open; the other type provides the ability for locking in either the de-energized or energized position.

### Types Available

	Series V	Series V316
<b>Media:</b>	Pneumatic Service	Pneumatic Service
<b>Pressure:</b> (minimum depends on valve size)	40 or 50 to 175 psi (2.8 or 3.5 - 12 bar)	40 to 175 psi (2.8 - 12 bar)
<b>Construction Materials:</b>	Forged & machined brass; NBR (nitrile) O ring seals	Investment cast & machined 316 stainless steel; FKM (fluorocarbon) seals
<b>Functional Type:</b>	3-way normally closed	3-way normally closed
<b>Body Style:</b>	Bodyported	Bodyported
<b>Port Sizes &amp; Flow:</b>	1/8"NPT or G1/8 (C <sub>v</sub> = 1.4, K <sub>v</sub> =20.3) 1/4"NPT or G1/4 (C <sub>v</sub> = 1.8, K <sub>v</sub> =26.1) 3/8"NPT or G3/8 (C <sub>v</sub> = 3.4, K <sub>v</sub> =49.3) 1/2"NPT or G1/2 (C <sub>v</sub> = 4.0, K <sub>v</sub> =58.0) 3/4"NPT (C <sub>v</sub> = 9.7, K <sub>v</sub> =140.6) 1"NPT (C <sub>v</sub> = 11.1, K <sub>v</sub> =161.0)	1/4"NPT (C <sub>v</sub> = 1.8, K <sub>v</sub> = 26) 3/8"NPT (C <sub>v</sub> = 2.0, K <sub>v</sub> = 29) 1/2"NPT (C <sub>v</sub> = 5.5, K <sub>v</sub> = 80)
<b>Actuation:</b>	Solenoid/pilot-spring return for either Ordinary Service or Hazardous Service	Solenoid/pilot-spring return for either Ordinary Service or Hazardous Service.

## Lockout Valves Product Number Selector

		Series V		Series V316		OPERATING PRESSURE	
FUNCTION	PORT SIZE	FLOW		LOCKOUT IN EXHAUST POSITION	LOCKOUT IN EITHER POSITION		
		C <sub>v</sub>	(kv)				
3-Way NC	1/8" NPT**	1.4	(20.3)	VIA-3221-138-LOVB-*	VIA-3221-138-LOVE-*	40-175 psi (2.8-12 bar)	
	1/4" NPT**	1.8	(26.1)	VIA-3321-138-LOVB-*	VIA-3321-138-LOVE-*		
	1/4" NPT	1.8	(26)		VIA-3321-316-138-LOVB-*		VIA-3321-316-138-LOVE-*
	3/8" NPT**	3.4	(49.3)	VIA-3421-138-LOVB-*	VIA-3421-138-LOVE-*		
	3/8" NPT	2.0	(29)		VIA-3421-316-138-LOVB-*		VIA-3421-316-138-LOVE-*
	1/2" NPT**	4.0	(58)	VIA-3521-138-LOVB-*	VIA-3521-138-LOVE-*		
	1/2" NPT	5.5	(80)		VIA-3521-316-138-LOVB-*	VIA-3521-316-138-LOVE-*	
	3/4" NPT	9.7	(140.6)	VIA-3621-138-LOVB-*	VIA-3621-138-LOVE-*	50-175 psi (3.5-12 bar)	
1" NPT	11.1	(161)	VIA-3721-138-LOVB-*	VIA-3721-138-LOVE-*			

\* Add coil code to valve number (ordinary page 27; hazardous page 26/29).

\*\* Valves with ISO 228 "G" threads are designated by utilizing Suffix "-2B" in model number

### Options

Options available for Series V Lockout Valve are the same as listed on page 13.

Options available for Series V316 Lockout Valve are the same as listed on page 19.

### Installation, Filtration and Lubrication

Valves have no limitations on mounting orientation.  
40 to 50 micron filtration and general purpose lubricating oil ISO, ASTM viscosity grade 32 recommended.  
Ambient temperature range -10°F (-23°C) to 200°F (95°C).

# SPECIAL PURPOSE DUAL SOLENOID VALVES

BRASS OR STAINLESS STEEL CONSTRUCTION

## Push Pull Solenoid Suffix-PPG

### General Description

A dual solenoid valve with a hand lever. The design concept is to provide the functionality of a, dual coil, 2-position valve with the addition of manual control or any other actuator. The valve operates as standard 2-position requiring only momentary electrical contact to shift valve. Various manual actuators are available. The lever shown is a -"L" type which can be manually set in either offset position when the solenoid valve is de-energized.

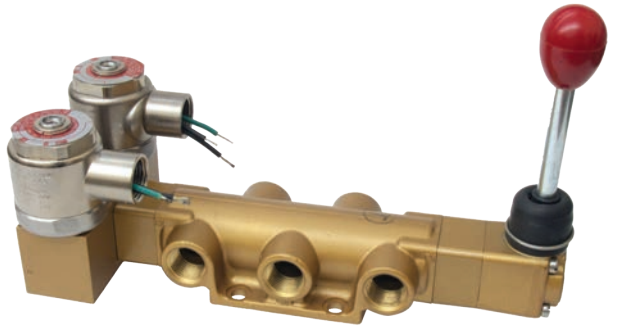

## Redundant Solenoid 2oo2, Suffix -RS

### General Description

When parallel electronic control circuits are utilized in a system, if a complete control circuit fails or requires maintenance, the parallel circuit will keep the system running. In a parallel circuit Versa's Redundant Valve functions the same as a solenoid operated-spring return valve, except that it has two solenoids (one for each of the parallel circuits) rather than one solenoid. Either or both of these solenoids will shift and maintain the controlled device in the shifted position. Both solenoids must be de-energized to return the controlled device to the un-shifted position. The use of one Redundant Valve can replace multiple valves and components to accomplish the same function. This function can be considered as a (2oo2).

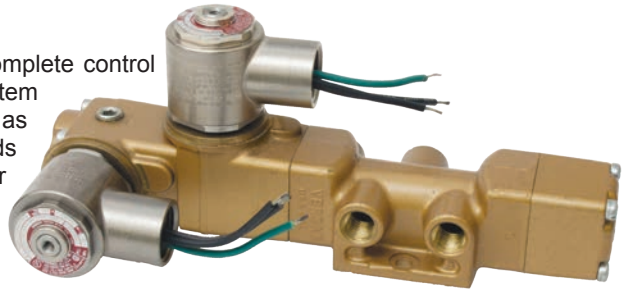

## Shut off Valve 1oo2, Suffix -SOV

### General Description

While the *Shut off Valve* looks similar to the *Redundant Solenoid Valve* (shown above) the internal pilot circuit is different. The -SOV option provides a series pilot control circuit that requires both coils, a primary and a secondary, to be energized in order for the valve to shift. Conversely if the electrical signal to either coil is removed the valve will return to the de-energized position. This function can be considered as a (1oo2). Where various control devices (e.g., temperature, pressure switches) could be wired in series with each coil. The actuation of any one of these devices, attached to either coil, would interrupt the signal to the coil and cause the valve to shift to the de-energized position.

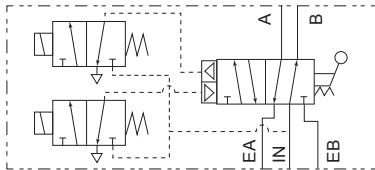
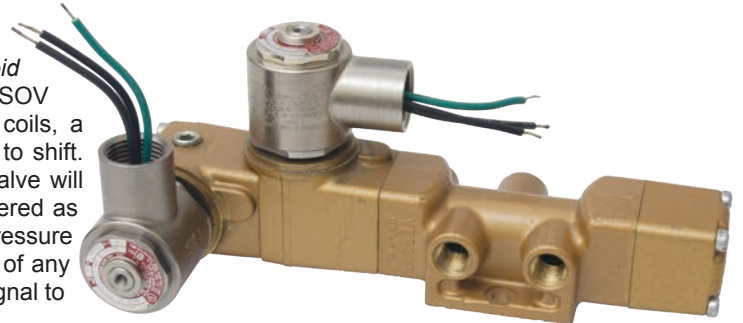

-PPG Flow Schematic

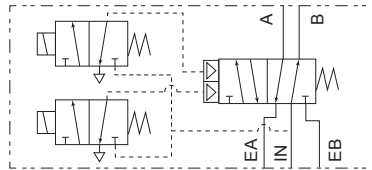

-RS Flow Schematic

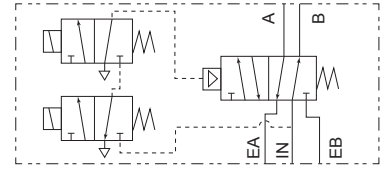

-SOV Flow Schematic

### Types Available

### SERIES V

### SERIES 316

Types Available	SERIES V	SERIES 316
<b>Media:</b>	Pneumatic Service	Pneumatic Service
<b>Pressure:</b>	50 to 175 psi (3.5 to 12 bar)†	40 to 175 psi (2.8 to 12 bar)†
<b>Construction Material:</b>	Forged & machined brass; NBR (nitrile) O ring seals	Investment cast & machined 316 stainless steel, FKM (fluorocarbon) seals
<b>Functional Types:</b>	3-way, normally closed 4-way, 2 position	3-way, normally closed 4-way, 2 position
<b>Port Sizes &amp; Flow:</b>	1/8" NPT or G1/8 (Cv=1.4,Kv=20.3) 1/4" NPT or G1/4 (Cv=1.8,Kv=26.1) 3/8" NPT or G3/8 (Cv=3.4,Kv=49.3) 1/2" NPT or G1/2 (Cv=4.0,Kv=58.0)	1/4" NPT (Cv=1.8,Kv=26) 3/8" NPT (Cv=2.0,Kv=29) 1/2" NPT (Cv=5.5,Kv=80)
<b>Actuation:</b>	Solenoid/pilot-spring return (2 solenoids per valve), for either ordinary or hazardous service.	Solenoid/pilot-spring return (2 solenoids per valve), for either ordinary or hazardous service.

# SPECIAL PURPOSE DUAL SOLENOID VALVES

## How to specify SPECIAL PURPOSE DUAL SOLENOID VALVES

**V SA - 3 5 2 1 - 316 - RS (OPTIONS)**

V = V Series brass or stainless steel.  
See page 12 for Series V,  
page 18 for Series V316.

LA = -PPG with Lever  
IA = -PPG with Button  
AA = -PPG with Latch, see page 25

SA = -RS -SOV with Spring Return  
AA = -RS -SOV with Latch, see page 25

3 = Three-way  
4 = Four-way

2 = 1/8"NPT (Series V\*\*) or V316)  
3 = 1/4"NPT (Series V\*\* or V316)  
4 = 3/8"NPT (Series V\*\* or V316)  
5 = 1/2"NPT (Series V\*\* or V316)

2 = Threaded sideports-INPilot solenoid: no auxiliary pilot required.

1 = 3-way NC  
2 = 3-way NO, 4-way/2-position  
3 = 4-way/3-position (blocked center)  
4 = 4-way/3-position (exhaust ports open in center)

Add "316" for stainless steel valves. Leave blank for brass

SPECIAL PURPOSE DUAL SOLENOID VALVES SUFFIX  
-RS  
-SOV  
-PPG

**OPTIONS** (Refer to pages 26 -29, 31 for specific certifications, standards & classifications, approvals, protective codes and voltage codes.)

\*\* Valves with ISO 228 "G" Threads are designated by utilizing suffix "-2B" in model number.

Installation, Filtration And Lubrication Valves have no limitations on mounting orientation. 40 to 50 micron filtration and general purpose lubricating oil ISO, ASTM viscosity grade 32 recommended. Ambient temperature range -10°F (-23°C) to 200°F (95°C).

## Dimensions

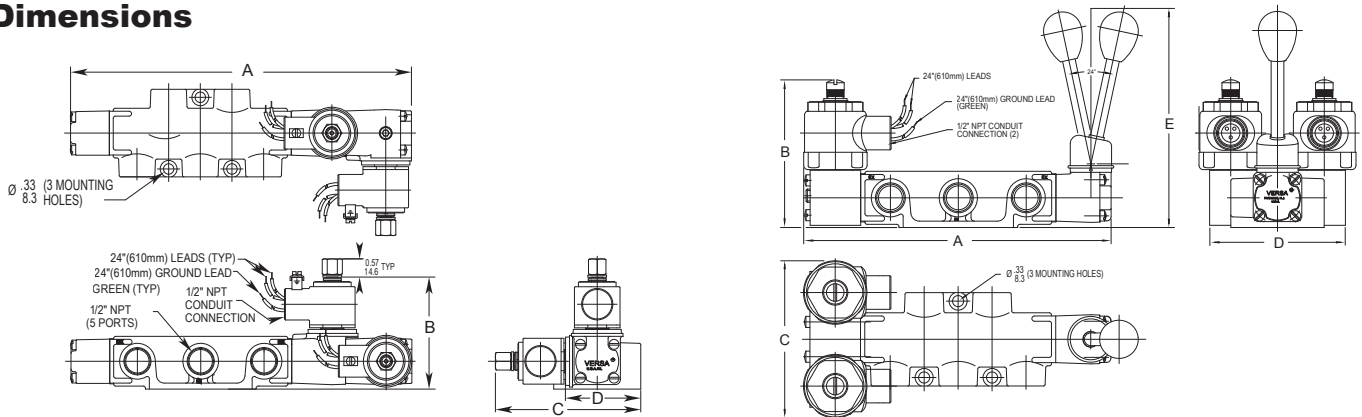

		SIZE	A	B†	C†	D
R S A	3	1/8 & 1/4	in 7.2	3.45	3.66	2
			mm 183	88	93	51
	4	3/8 & 1/2	in 8.78	3.43	4.18	2.76
			mm 223	87.2	106.1	70
S O V	3	1/8 & 1/4	in 8.50	3.45	3.66	2
			mm 216	88	93	51
	4	3/8 & 1/2	in 10.75	3.50	4.02	2.76
			mm 273	89	102	70

		SIZE	A	B†	C†	D	E
P P G	3	1/8 &	5.49	3.80	1.30	2.0	6.37
		1/4	139	96.6	96.6	50.8	162
		3/8 &	7.05	4.35	4.62	2.75	6.45
	4	1/2	179	110.4	117.4	69.9	163.9
		1/8 &	6.81	3.80	4.62	2.0	6.37
		1/4	173	96.6	117.4	50.8	161.9
A	3/8 &	9.05	4.35	4.62	2.75	6.45	
	1/2	230	110.4	117.4	69.9	163.9	

† Dimensions listed are for -XX type hazardous service solenoids. For dimensions with other hazardous service solenoids that can be applied, consult factory. Dimensions for standard non-hazardous service solenoids will be slightly less than those listed.

# LATCHING/MANUAL RESET VALVES

BRASS OR STAINLESS STEEL CONSTRUCTION

## General Description

Latching valves are particularly suited to applications where it is desirable or mandatory to manually reset or restart a system. A typical application could involve the emergency shutdown of automatically monitored process operations. Loss or interruption of the control signal to the valve actuator causes the valve to shift, latch and shut-down a process step. When the signal is restored the valve remains in the latched position until the operator manually unlatches it and allows the process step to resume. Positive latching in such an application is vitally important since many process operations are sequential and one step must not be started until the one ahead of it has started.

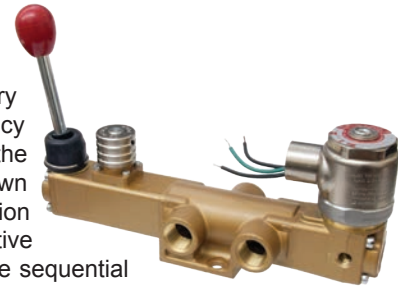

This example is only one of many which can be accommodated through the use of Versa's Latching Valves. A wide range of functional types, port sizes, actuators, and latching arrangements provide the engineer with a complete choice of valving to suit his particular needs.

Types Available	Series V	Series V316
Media	Pneumatic; others, consult factory.	Pneumatic and various other gases, including corrosives.
Pressure: (minimum depends on size and type)	20 or 55 to 175 psi (1.4 or 3.8 to 12 bar)	20 or 55 to 175 psi (1.4 or 3.8 to 12 bar)
Construction Materials	Forged & machined brass; NBR (nitrile) O ring seals	Investment cast & machined 316 stainless steel; FKM (fluorocarbon) seals
Functional Type	3-way normally closed 3-way normally open 3-way 3-position 4-way 2 & 3 position	3-way normally closed 3-way normally open 3-way 3-position 4-way 2 & 3 position
Body Style	Bodyported	Bodyported
Port Sizes & Flow	1/8" NPT or G1/8 (Cv = 1.4, Kv = 20.3) 1/4" NPT or G1/4 (Cv = 1.8, Kv = 26.1) 3/8" NPT or G3/8 (Cv = 3.4, Kv = 49.3) 1/2" NPT or G1/2 (Cv = 4.0, Kv = 58.0) 3/4" NPT (Cv = 9.7, Kv = 140.6) 1" NPT (Cv = 11.1, Kv = 161.0)	1/4" NPT (Cv = 1.8, Kv = 26) 3/8" NPT (Cv = 2.0, Kv = 29) 1/2" NPT (Cv = 5.5, Kv = 80)
Actuation	Solenoid/pilot for either ordinary service or hazardous service.	Solenoid/pilot for either ordinary service or hazardous service.

## LATCHES IN ACTUATED POSITION

Suffix "-181B"

Latches automatically when plunger shifts on signal. Unlatching allows plunger to be returned by hand.

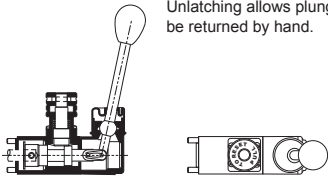

## Latching/Reset Devices For Series V or V316 Valves

The Latching Device actuator consists of the latch, with or without an integral spring for returning the valve plunger, and an inline hand operator where needed to manually shift the valve.

The specific Latching Device may be attached to any Series "V" valve body size or style up to 1" NPT or any Series V316 valve body up to 1/2" NPT, as indicated for the type of latching/reset device required. The actuator on the opposite end of the valve body would be a solenoid/pilot device.

## LATCHES IN UN-ACTUATED POSITION

Suffix "-181D"

Unlatching allows plunger to shift on signal. If signal is lost, spring shifts plunger automatically and valve latches. When signal is restored, plunger will not shift until manually unlatched. Hand lever is provided for manual operation. (If hand lever is not required see suffix -3358 below.)

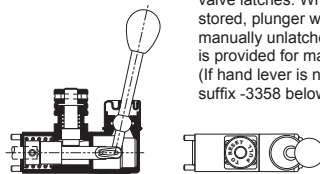

## LATCHES IN EITHER POSITION

Suffix "-181AA"

(2 position latch) Valve may be manually latched in either offset position or left unlatched. Acts as spring return valve when not latched. Hand lever is provided for hand operation.

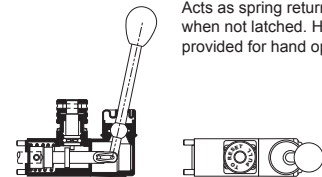

Suffix "-181C"

Latches automatically when plunger shifts on signal. Unlatching allows spring to reset plunger automatically. Hand lever provided for manual operation. (If hand lever is not required see suffix -3358A below.)

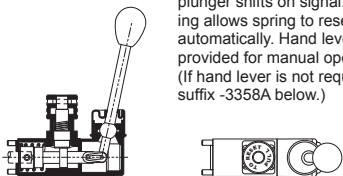

Suffix "-3358"

Unlatching allows plunger to shift on signal. Spring returns plunger automatically and valve latches. (If hand lever is required for manual actuation see suffix -181D above.)

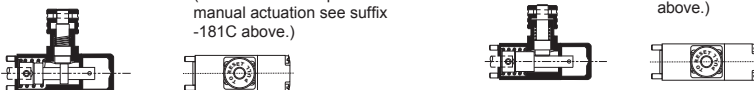

Suffix "-3358A"

Latches automatically when plunger shifts on signal. Unlatching allows spring to reset plunger automatically. (If hand lever is required for manual actuation see suffix -181C above.)



## How to specify LATCHING/RESET VALVES

**V AG - 3 5 2 1 - 181B - (OPTIONS)**

V = Pneumatic service: nominal 20 to 175 psi (1.4 - 12 bar); pressure range may vary depending upon specific valve type. See page 12 for Series V, page 18 for Series V316.

AG=Solenoid/pilot operated for 3-way NC or 4-way  
GA=Solenoid/pilot operated for 3-way NO

3 = Three-way  
4 = Four-way

2 = 1/8"NPT (Series V\*)  
3 = 1/4"NPT (Series V\* or V316)  
4 = 3/8"NPT (Series V\* or V316)  
5 = 1/2"NPT (Series V\* or V316)  
6 = 3/4"NPT (Series V)  
7 = 1"NPT (Series V)

2 = Threaded sideports-INPilot solenoid: no auxiliary pilot required.

1 = 3-way NC  
2 = 3-way NO, 4-way/2-position  
3 = 4-way/3-position (blocked center)  
4 = 4-way/3-position (exhaust ports open in center)

	Series V	Series V316
Locking Reset Device	181AA	316-181AAE
	181AB	316-181ABE
(refer to page 22 for specific device required)	181B	316-181B
	181C	316-181C
	181D	316-181D
	3358	316-3358
	3358A	316-3358A

OPTIONS	Series V	Series V316	
Electrical Connection/Coil Cover	-HC -HCC	-HC -HCC	
Seals	-11 -155		
Solenoids for Hazardous Service	-XX -3567	-XX -LB,XX	
	-XN -AJB-PS-XN -XDAS, T -LB,-XN	-XN -AJB-PS-XN -XDAS, T -LB,XN	Flameproof
	-XMAA, E, F, G -XMFA, E, F, G	-XMAA, E, F, G -XMFA, E, F, G	Encapsulation
	-HC-XISC -HCC-XISC -HC-XISX6 -HCC-XISX6 -XIFA, F	-HC-XISC -HCC-XISC -HC-XISX6 -HCC-XISX6 -XIFA, F	Intrinsically safe
Options for Special Conditions	-3 -PS -HT -G,-M,-M5R -TR50-ST -E14	---- -PC -HT -ME -ST -L14	Fluorocarbon NEMA 4 High Temperature Overrides Stainless Steel Dust Excluders

**OPTIONS** (Refer to pages 26 to 31 for specific certifications, standards & classifications, approvals, and protective codes.)

Voltage (coil code) See page 27



\*Valves with ISO 228 "G" Threads are designated by utilizing suffix "-2B" in model number.

**Installation, Filtration And Lubrication** Valves have no limitations on mounting orientation. 40 to 50 micron filtration and general purpose lubricating oil ISO, ASTM viscosity grade 32 recommended. Ambient temperature range -10°F (-23°C) to 200°F (95°C).



# SOLENOID PILOT – ELECTRICAL OPERATOR SPECIFICATIONS

Solenoid/Pilot actuated valves are available with a variety of different solenoids for both nonhazardous and hazardous locations. Basic details of actuators for hazardous locations are listed below. Details for nonhazardous location actuators are listed on pages 26-27. For additional data consult factory. Product numbers and other details may be found on the appropriate pages for each specific valve type and series



## NONHAZARDOUS LOCATION SOLENOIDS (Inline or upright style)

	Suffix Identification	Protection Classification	Area Classification and (Gas Grouping)	Certification-(Conformance)	Ingress Protection
	None or -U	General Purpose	Indoor & Outdoor	CSA	NEMA 1,2,3
	-HC -HCC (Shown)	General Purpose	Indoor & Outdoor	CSA	NEMA 4; IP65

## HAZARDOUS LOCATION SOLENOIDS

	Suffix Identification	Protection Classification	Area Classification and (Gas Grouping)	Certification-(Conformance)	Ingress Protection
	-XX	Hazardous Locations	CLASS I, DIV. 1 (C & D) CLASS I, DIV. 2 (A & B) CLASS II, DIV. 1 (E, F & G)	UL - CSA	NEMA 7 & 9
	-LB-XX				
	-XN	(d) Flameproof	Ex d IIB+H2 T3 to T6 Gb II 2 G Ex d IIB+H2 T3 to T6	IECEX	P66 & IP68
	-LB-XN			ATEX	
	-XDBS* -XDBT*	(d) Flameproof (e) Increased Safety	EX II 2 G D Ex d e IIC T* Gb EX tb IIIC T* °C Db  Class I Div I Grp B, C & D Class I Div II Grp E, F & G EX d IIC DIP A21 T6 T4	ATEX ATEX - IECEX -INMETRO  CSA	IP66, IP67, & IP68  NEMA 4, 4X 6P

\*For ordering information see "Miscellaneous" column page 27

	-XMAA -XMAE -XMAF	(mb) Encapsulation (e) Increased Safety (tD) Tight Dust	Ex e mb II T5, T6 Gb Ex tD A21 T100°C, T85°C Db  II 2 G Ex e mb II T5, T6 II 2D Ex tD A21 T100°C, T85°C	IECEX	IP66 & IP67
	-XMFA -XMFE -XMFF			ATEX	
	-XIFA -XIFE -XIFF	(ia) Intrinsic Safe	Ex (ia) IIC T4...T6 Gb Ex (ia) IIIC T130°C, T80°C Db  II 2 G Ex ia IIC T4...T6 II 2 D Ex iaD 21 T130°C, T80°C	IECEX	IP66 & IP67
	-XISX6			ATEX	
	-XISC	Intrinsic Safe	Class I, Groups (A, B, C & D) Class II, Groups (E, F, & G) Class III	Factory Mutual CSA	IP65

\*For XDAS or XDAT consult factory

**PRODUCT NUMBER COIL CODES:** Complete product numbers require, when applicable, a coil code that represents the desired coil current, frequency and voltage. The coil code takes the form shown below, with ratings and voltage substituted as required.

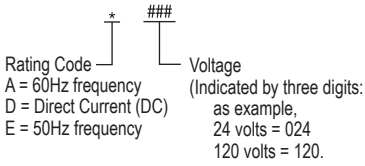





Voltage (Power)	Electrical Characteristics	Miscellaneous
All usual 50 Hz & 60 Hz AC (7.3W) All usual DC (9.5W)	Class F epoxy molded coil (155°C). Continuous duty, 2 leads 24" (60 cm).	Steel cover with 1/2 NPT conduit entry.
24V60, 120V60, 240V60 (8.5W) 24V50, 110V50, 220V50 (8.5W) 12VDC, 24VDC, 48VDC (10.5W)	Class F epoxy molded coil (155°C), with 3 spade terminals and mini DIN socket with PG9 cable gland. Continuous duty.	



Voltage (Power)	Electrical Characteristics	Miscellaneous																													
All usual 50 Hz & 60 Hz AC (5.6W) All usual DC (7.2W)	Class F epoxy molded coil (155°C). continuous duty. 3 leads 24" (60 cm).	Plated steel coil housing with 1/2 NPT conduit entry. For stainless steel (182FM) coil housing add: (-ST)																													
12V60, 24V60, 48V60, 120V60, 240V60 (1.8W) 6VDC, 12VDC, 24VDC, 48VDC (1.8W)		Plated steel coil housing with 1/2 NPT conduit entry. For stainless steel (182FM) coil housing add: (-ST) Maximum pilot pressure 120 psi (8 bar). 1.8W nominal power.																													
All usual 50 Hz & 60 Hz AC (5.6W) All usual DC (7.2W)	Class F epoxy molded coil (155°C). continuous duty. 3 leads 24" (60 cm).	Plated steel coil housing with M20 x 1.5 conduit entry. Ground terminal on cover. For stainless steel (182FM) coil housing add: (-ST)																													
12V60, 24V60, 48V60, 120V60, 240V60 (1.8W) 6VDC, 12VDC, 24VDC, 48VDC (1.8W)		Steel chromate coated coil housing with M20 x 1.5 conduit entry. Ground terminal on cover. For stainless steel (182FM) coil housing add: (-ST) Maximum pilot pressure 120 psi (8 bar) 1.8W nominal power.																													
24VDC (D024) 120V60 (A120) 110V50 (E110) 230V50 (E230)  1.8 Watt standard, for lower watt contact factory.	Epoxy molded coils rated for continuous duty, Class H – 180°C.	<table border="1"> <thead> <tr> <th rowspan="2">Suffix Detail Ordering Code</th> <th colspan="2">M 20 Connection</th> <th colspan="2">1/2" Connection</th> </tr> <tr> <th>No Diode</th> <th>Diode</th> <th>No Diode</th> <th>Diode</th> </tr> </thead> <tbody> <tr> <td>Standard (vent to atmosphere)</td> <td>XDBS1</td> <td>XDBS5</td> <td>XDBT1</td> <td>XDBT5</td> </tr> <tr> <td>1/8" Adapter (-H2E)</td> <td>XDBS2</td> <td>XDBS6</td> <td>XDBT2</td> <td>XDBT6</td> </tr> <tr> <td>1/4" Adapter (-H2)</td> <td>XDBS3</td> <td>XDBS7</td> <td>XDBT3</td> <td>XDBT7</td> </tr> <tr> <td>Dust Nut (-L14)</td> <td>XDBS4</td> <td>XDBS8</td> <td>XDBT4</td> <td>XDBT8</td> </tr> </tbody> </table>	Suffix Detail Ordering Code	M 20 Connection		1/2" Connection		No Diode	Diode	No Diode	Diode	Standard (vent to atmosphere)	XDBS1	XDBS5	XDBT1	XDBT5	1/8" Adapter (-H2E)	XDBS2	XDBS6	XDBT2	XDBT6	1/4" Adapter (-H2)	XDBS3	XDBS7	XDBT3	XDBT7	Dust Nut (-L14)	XDBS4	XDBS8	XDBT4	XDBT8
Suffix Detail Ordering Code	M 20 Connection			1/2" Connection																											
	No Diode	Diode	No Diode	Diode																											
Standard (vent to atmosphere)	XDBS1	XDBS5	XDBT1	XDBT5																											
1/8" Adapter (-H2E)	XDBS2	XDBS6	XDBT2	XDBT6																											
1/4" Adapter (-H2)	XDBS3	XDBS7	XDBT3	XDBT7																											
Dust Nut (-L14)	XDBS4	XDBS8	XDBT4	XDBT8																											
24VDC (4W) (Consult factory for other voltage options)	Continuous duty coil & rectifier, including surge suppression, potted within housing.	Thick wall epoxy coil housing with integral junction box. Internal ground terminal. M20 x 1.5 conduit entry: (-XMAA), (-XMFA), Cable gland for 6-12 mm ø cable: (-XMAE), (-XMFE) 1/2 NPT conduit entry with adapter: (-XMAF), (-XMFF)																													
24VDC (10W inrush, 2.6W holding) (Consult factory for other voltages)	Continuous duty coil & power controller potted within housing.																														
24VDC (0.8W) (Consult factory for other voltages)	Continuous duty Coil and power controller potted within housing.	Requires the use of an approved safety barrier or isolator. Thick wall epoxy coil housing and integral junction box. Internal ground terminal. M20 x 1.5 conduit entry: (-XIFA) Cable gland for 6-12 mm ø cable: (-XIFE) 1/2 NPT conduit entry with adapter: (-XIFF)																													
24VDC system voltage prior to barrier (1.6 watt max.)	Class F epoxy molded coil (155°C). Continuous duty.	Requires the use of an approved barrier or isolator. Maximum operating system voltage before barrier 28VDC. Maximum pilot pressure 115 psi (8 bar). 3 spade terminals & DIN connector with PG9 cable gland: (-HC) 1/2 NPT conduit entry: (-HCC)																													

# OPTIONS AVAILABILITY CHART





## Solenoid Options - Nonhazardous Location

		VALVE SERIES								
		NAMUR C5	NAMUR E5	NAMUR C316	C5/C7	E	E5	V	C316	V316
	1/2" NPT Conduit entry, NEMA 1,2,3	-C50	-C50	std	-C50	std	std	std	std	std
	1/2" NPT Conduit entry, Potted coil NEMA 4 & 4X, 11, 12, 13.	-PC	-PC	-PC	-PC	-PC	-PC	-PC	-PC	-PC
	1/2" NPT Conduit Integrally Molded Coil & Conduit Entry, NEMA 4/IP65.	-228L	-228L	n/a	-228L	n/a	n/a	n/a	n/a	n/a
	3 Spade Terminals, for use with mini DIN connector	std	std	n/a	std	n/a	n/a	n/a	n/a	n/a
	Mini DIN Connector with PG9 cord grip, NEMA 4.	-HC	-HC	-HC	-HC	-HC	-HC	-HC	-HC	-HC
	Mini DIN Connector with 1/2" NPT conduit entry, NEMA 4.	-HCC	-HCC	-HCC	-HCC	-HCC	-HCC	-HCC	-HCC	-HCC

## Solenoid Options - hazardous Location



		VALVE SERIES								
		NAMUR C5	NAMUR E5	NAMUR 316	C5/C7	E	E5	V	C316	V316
	1/2" NPT Conduit entry, NEMA 7 & 9, UL & CSA.	-XX	-XX	-XX	-XX	-XX	-XX	-XX	-XX	-XX
	M20 x 1.5 Conduit entry, (d) Flameproof, IP66, T4, ATEX	-XN	-XN	-XN	-XN	n/a	-XN	-XN	-XN	-XN
	Stainless steel (182 FM) coil cover for -XX Hazardous Location Options:	-XX	-XX	-XX	-XX	n/a	-XX	-TR50-XX	-XX	-XX
		-ST	-ST	-ST	-ST	n/a	-ST	-ST	-ST	-ST
	Potted Coil (female threaded conduit connection) for Hazardous Location options, NEMA 4X, 11, 12, 13:	-XX	-XX	-XX	-XX	n/a	-XX	-TR50-XX	-XX	-XX
		-XN	-XN	-XN	-XN	n/a	-XN	-XN	-XN	-XN
	Potted Coil (male threaded conduit connection) for -XX Hazardous Location options, NEMA 4X, 11, 12, 13.	n/a	n/a	n/a	n/a	-PS	n/a	-PS	n/a	n/a
	LOW WATT (1.8W) Solenoid: For -XX Hazardous Location option; NEMA 7 & 9, UL & CSA.	LB-XX	LB-XX	LB-XX	LB-XX	n/a	LB-XX	3567	LB-XX	LB-XX
	For -XN Hazardous Location option; T6, ATEX.	LB-XN	LB-XN	LB-XN	LB-XN	n/a	LB-XN	LB-XN	LB-XN	LB-XN

## Solenoid Options - Hazardous Location Cont.

		VALVES SERIES								
		NAMUR		NAMUR	C5/C7	E	E5	V	C316	V316
		C5	E5	C316						
 <p>(e) Increased Safety (d) Flameproof <b>ATEX:</b> EX II 2 G D Ex d e IIC T* Gb  <b>IEC/EX:</b> EX tb IIIC T* °C Db EXd IIC DIP A21 T6 T4  <b>CSA:</b> CI Div I Grp B, C &amp; D CI Div II Grp E, F &amp; G</p>		n/a	n/a	-XDBS*	n/a	-XDBS*	n/a	-XDBS*	-XDBS*	-XDBS*
		n/a	n/a	-XDBT*	n/a	-XDBT*	n/a	-XDBT*	-XDBT*	-XDBT*
 <p>(e) Increased Safety (m) Encapsulated (tD) Dust Tight <b>IECEx</b> Ex e Ex mb, Ex tD Ex e mb II T5, T6 Gb Ex tD A21 T100°C, 85°C  <b>ATEX</b> EEx II 2 G Ex e mb II T5, T6 Ex tD A21 T100°C, 85°C</p>		n/a	n/a	-XMAA	n/a	-XMAA	n/a	n/a	-XMAA	-XMAA
		n/a	n/a	-XMAE	n/a	-XMAE	n/a	-XMAE	--	-XMAE
		n/a	n/a	-XMAF	n/a	-XMAF	n/a	-XMAF	-XMAF	-XMAF
		n/a	n/a	--	n/a	-XMAG	n/a	-XMAG	--	-XMAG
 <p>(ia) Intrinsic Safe <b>ATEX</b> EEx II 2 G EEx ia IIC T4, T5</p>		n/a	n/a	-XMFA	n/a	XMFA	n/a	-XMFA	-XMFA	-XMFA
		n/a	n/a	--	n/a	-XMFE	n/a	-XMFE	n/a	-XMFE
		n/a	n/a	-XMFF	n/a	-XMFF	n/a	-XMFF	-XMFF	-XMFF
		n/a	n/a	--	n/a	-XMFG	n/a	-XMFG	--	-XMFG
 <p>Factory Mutual &amp; CSA Class I, Groups (A, B, C, D) Class II, Groups (E, F &amp; G) Class III, Division 1</p>		-HC-XISC	n/a	-HC-XISC	-HC-XISC	n/a	-HC-XISC	-HC-XISC	-HC-XISC	-HC-XISC
		-HCC-XISC	n/a	-HCC-XISC	-HCC-XISC	n/a	-HCC-XISC	-HCC-XISC	-HCC-XISC	-HCC-XISC
<p>(ia) Intrinsic Safe <b>ATEX</b> EEx II 2 G EEx ia IIC T4, T5</p>		n/a	n/a	-HC-XISX6	-HC-XISX6	n/a	-HC-XISX6	-HC-XISX6	-HC-XISX6	-HC-XISX6
		n/a	n/a	-HCC-XISX6	-HCC-XISX6	n/a	-HCC-XISX6	-HCC-XISX6	-HCC-XISX6	-HCC-XISX6

\* For ordering information see "Miscellaneous" column page 27.  
For -XDAS and -XDAT consult factory for specifications.

## Miscellaneous Options

		VALVE SERIES								
		NAMUR C5	NAMUR E5	NAMUR C316	C5/C7	E	E5	V	C316	V316
<p><b>Manual Override</b> (Manually pressurizes pilot of solenoid/ pilot actuator)</p>  <p>-CML: Unguarded locking type; push to operate and turn to lock. -G: Guarded manual override -MAE: Unguarded, manual override -ME: Unguarded type; push &amp; hold to operate. -M5R: Unguarded locking manual override with a knurled knob, push to actuate and turn to lock.</p>		—	—	-ME	—	-MAE	—	-M	-ME	-ME
		-CML	—	—	-CML	-M5R	—	-M5R	—	—
		G	—	—	G	-M	—	-G	—	—
<p><b>Low Temperature Service</b></p> <p>-EP: Ethylene-Propylene Seals -44: Low Temperature.</p>		—	-EP	—	—	-EP	-EP	-EP	—	-EP
		-44	-44	-44	-44	-44	-44	-44	-44	-44
<p><b>Coil Options</b></p>  <p>-L14: Silencer/Dust Excluder -D14: Water &amp; Dust Excluder / Silencer</p>		-L14	-L14	-L14	-L14	-E14	-L14	-E14	-L14	-L14
		-D14	-D14	-D14	-D14	D14	-D14	-D14	-D14	-D14
<p><b>Natural Gas Service</b></p> <p>-NGS: The standard V-316 Series product is rated for air and gas service including natural gas. Versa recommends suffix detail -NGS for enhanced performance -NGST: For low temperature applications.</p>		—	—	std	-NGS	std	std	-NGS	std	-NGS
		—	—	-NGST	-NGST	std	std	-NGST	-NGST	-NGST
<p><b>Stainless Steel Tag</b></p> <p>P- 2002-16-NV28A: Stainless Steel Tag part number Two configurations: 1) Two lines of text, up to 20 characters. 2) Two lines, one line is text, the second is sequential numbering, 20 characters per line. Consult factory for ordering details.</p> 		Yes	Yes	Yes	Yes	—	—	Yes	Yes	Yes

# MISCELLANEOUS INFORMATION

## Hazardous Location Combination Suffix Details

### Cross Reference Chart

Suffix Reference	
Suffix	Description
-XX	North American solenoid
-XN	ATEX solenoid
-XDB	World Solenoid
-HT	Class H coil
-ST	Stainless solenoid housing
-PC	Potted coil
-LB	1.8 watt solenoid
-LA	0.85 watt solenoid
-VJBT	Add on Junction Box
-D14	Solenoid vent, water proof nut
-PS	Potted coil, male conduit
-CD	72" wire leads
-LX	1.8 watt solenoid
-H2E	1/8" npt solenoid vent
-HE	1/4" npt solenoid vent
-L14	solenoid vent dust nut
-303D	Integral diode

North American (-XX) (Cont.)	
Combination Suffix	Included Suffix
-XXH4	-XX, -D14, -HT, -PC, -ST
-XXJ	-XX, -LB, -PC, -ST
-XXJ4	-XX, -D14, -LB, -PC, -ST
-XXK	-XX, -HT, -LB, -PC, -ST
-XXK4	-XX, -D14, -HT, -LB, -PC, -ST
-XXL	-XX, -PC
-XXL4	-XX, -D14, -PC
-XXM	-XX, -HT, -PC
-XXM4	-XX, -D14, -HT, -PC
-XXN	-XX, -LB, -PC
-XXN4	-XX, -D14, -LB, -PC
-XXP	-XX, -HT, -LB, -PC
-XXP4	-XX, -D14, -HT, -LB, -PC
-XXQ	-XX, -HT, -LB
-XXQ4	-XX, -D14, -HT, -LB
-XXR	-XX, -LB
-XXR4	-XX, -D14, -LB
-XXS	-XX, -LA, -ST
-XXS4	-XX, -D14, -LA, -ST
-XXU	-XX, -HT, -LB, -ST
-XXU4	-XX, -D14, -HT, -LB, -ST
-XXV	-XX, -LA
-XXV4	-XX, -D14, -LA
-XXW	-XX, -CD, -HT, -H2, -PC, -ST
-XXW4	-XX, -D14, -CD, -HT, -PC, -ST

ATEX (XN) (Cont.)	
Combination Suffix	Included Suffix
-XNL	-XN, -PC
-XNM	-XN, -HT, -PC
-XNN	-XN, -LB, -PC
-XNP	-XN, -HT, -LB, -PC
-XNQ	-XN, -HT, -LB
-XNR	-XN, -LB
-XNS	-XN, -LA, -ST
-XNU	-XN, -HT, -LB, -ST
-XNV	-XN, -LA
-XNX	-XN, -LB, -PS
-XNWS	-XN, -VJBT, -LB, -PS
-XXK4	-XX, -D14, -HT, -LB, -PC, -ST

North American (-XX)	
Combination Suffix	Included Suffix
-XXA	-XX, -HT
-XXA4	-XX, -D14, -HT
-XXB	-XX, -PS
-XXB4	-XX, -D14, -PS
-XXC	-XX, -HT, -PS
-XXC4	-XX, -D14, -HT, -PS
-XXD	-XX, -ST
-XXD4	-XX, -D14, -ST
-XXE	-XX, -PC, -ST
-XXE4	-XX, -D14, -PC, -ST
-XXF	-XX, -HT, -ST
-XXF4	-XX, -D14, -HT, -ST
-XXG	-XX, -LB, -ST
-XXG4	-XX, -D14, -LB, -ST
-XXH	-XX, -HT, -PC, -ST

ATEX (XN)	
Combination Suffix	Included Suffix
-XNA	-XN, -HT
-XND	-XN, -ST
-XNE	-XN, -PC, -ST
-XNF	-XN, -HT, -ST
-XNG	-XN, -LB, -ST
-XNH	-XN, -HT, -PC, -ST
-XNJ	-XN, -LB, -PC, -ST
-XNK	-XN, -HT, -LB, -PC, -ST

World Solenoid (XDB)	
Combination Suffix	Included Suffix
-XDBS1	-XDBS, -HT, -LX
-XDBS2	-XDBS, -HT, -LX, -H2E
-XDBS3	-XDBS, -HT, -LX, -HE
-XDBS4	-XDBS, -HT, -LX, -L14
-XDBS5	-XDBS, -HT, -LX, -303D
-XDBS6	-XDBS, -HT, -LX, -H2E, -303D
-XDBS7	-XDBS, -HT, -LX, -HE, -303D
-XDBS8	-XDBS, -HT, -LX, -L14, -303D
-XDBS9	-XDBS, -HT, -LX, -D14
-XDBS10	-XDBS, -HT, -LX, -D14, -303D
-XDBT1	-XDBT, -HT, -LX
-XDBT2	-XDBT, -HT, -LX, -H2E
-XDBT3	-XDBT, -HT, -LX, -HE
-XDBT4	-XDBT, -HT, -LX, -L14
-XDBT5	-XDBT, -HT, -LX, -303D
-XDBT6	-XDBT, -HT, -LX, -H2E, -303D
-XDBT7	-XDBT, -HT, -LX, -HE, -303D
-XDBT8	-XDBT, -HT, -LX, -L14, -303D
-XDBT9	-XDBT, -HT, -LX, -D14
-XDBT10	-XDBT, -HT, -LX, -D14, -303D

# Modular Air Package



Based on the V316 Series

## General Description

The Versa Modular Air Package is a compact air management system, based on V316 Series components, that will provide a full range of pneumatic accessories and functions to meet the needs of most control systems in the actuator control industry. Major components are shutoff and check valves, filter/regulators, speed controls and directional control valves.

## Design Benefits

Versa's VMAP simplifies the design process by combining all the components of a common circuit into one integrated assembly. Whether a standard shutoff circuit or an intricate control system, VMAP has the features to meet the requirements of any control project. VMAP will reduce engineering, components, vendors, costs, weight and save time.

**TROUBLE FREE.** Designed with integral assembly flanges combined with all O ring interface sealing and standard fasteners. Long leak free service life is accomplished. No custom or flat gaskets to leak or brackets to fail.

**TECHNOLOGY.** Utilizing the latest in computer aided design and finite element software flow is maximized yielding the highest flow in the smallest of packages.

**CUSTOM CIRCUITRY** is achieved through modular design by simply combining various components to create the desired circuit

**RELIABILITY.** The reliability of the Versa V-316 Series combined with industry approved materials yields a proven product. SIL (Safety Integral Levels) exceeding most application requirements.

**EFFICIENCY.** VMAP's modular design effectively groups common automation and controls components together in user approved groupings to combine features and reduce size and weight.

**PROVEN.** VMAP is based on Versa's field proven V-316 Series product. Over 30 years of acceptance in providing bubble tight sealing though Versa's packed plunger technology.

**FLEXIBILITY.** Many standard and custom circuits are easily created using the VMAP modular concept.

**INNOVATIVE.** Through the use of investment casting technology main components are integrated saving space while reducing potential leakage points.

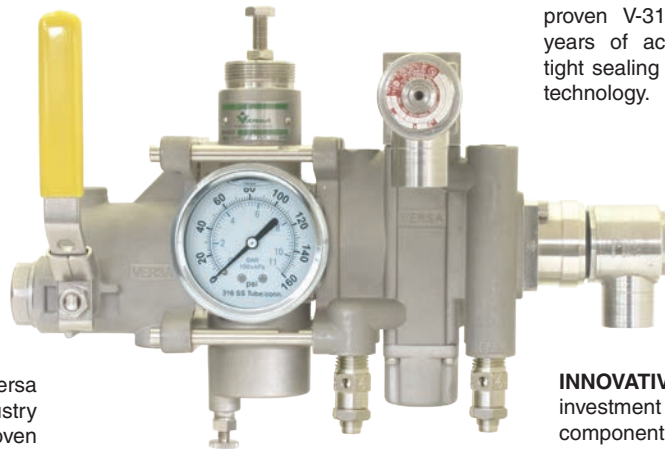

## ENGINEERING BENEFITS

- Standard or custom circuits available utilizing VMAP's modular components.
- Convenience of one purchase order and one vendor.
- No need for developing Bill or Materials for fittings, tubing and bracketing.
- No need for designing complete layout of many different system components.
- No need for designing brackets for many individual components.

## FIELD BENEFITS

- Repairability ease; by removing a few screws and the various modules can be disassembled and inspected, no tubing or fittings to remove
- Field configurability of function after installation; add more valves as the requirements of the process change.
- 10 year warranty

## INSTALLATION BENEFITS

- Reducing fittings, tubing and related labor costs
- Reduction in size and weight
- One component to mount.

## Current Technology

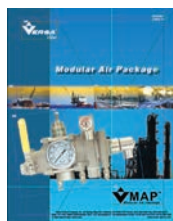

See VMAP Bulletin online at Versa Website

**NEW**



VMAP and Panel shown at scale

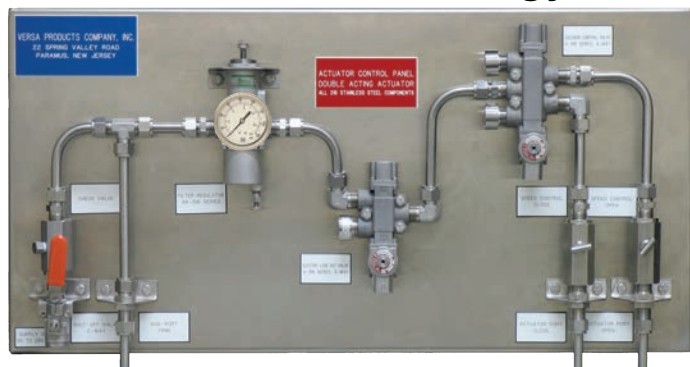

## WARNINGS REGARDING THE DESIGN APPLICATION, INSTALLATION AND SERVICE OF VERSA PRODUCTS

The warnings below must be read and reviewed before designing a system utilizing, installing, servicing, or removing a Versa product. Improper use, installation or servicing of a Versa product could create a hazard to personnel and property.

### DESIGN APPLICATION WARNINGS

Versa products are intended for use where compressed air or industrial hydraulic fluids are present. For use with media other than specified or for non-industrial applications or other applications not within published specifications, consult Versa.

Versa products are not inherently dangerous. They are only a component of a larger system. The system in which a Versa product is used must include adequate safeguards to prevent injury or damage in the event of system or product failure, whether this failure be of switches, regulators, cylinders, valves or any other system component. System designers must provide adequate warnings for each system in which a Versa product is utilized. These warnings, including those set forth herein, should be provided by the designer to those who will come in contact with the system.

Where questions exist regarding the applicability of a Versa product to a given use, inquiries should be addressed directly to the manufacturer. Confirmation should be obtained directly from the manufacturer regarding any questioned application prior to proceeding.

### INSTALLATION, OPERATION AND SERVICE WARNINGS

Do not install or service any Versa product on a system or machine without first depressurizing the system and turning off any air, fluid, or electricity to the system or machine. All applicable

electrical, mechanical, and safety codes, as well as applicable governmental regulations and laws must be complied with when installing or servicing a Versa product.

Versa products should only be installed or serviced by qualified, knowledgeable personnel who understand how these specific products are to be installed and operated. The individual must be familiar with the particular specifications, including specifications for temperature, pressure, lubrication, environment and filtration for the Versa product which is being installed or serviced. Specifications may be obtained upon request directly from Versa. If damages should occur to a Versa product, do not operate the system containing the Versa product. Consult Versa for technical information.

### LIMITED WARRANTY DISCLAIMER AND LIMITATION OF REMEDIES

Products sold by Versa are warranted to be free from defective material and workmanship for a period of ten years from the date of manufacture, provided said items are used in accordance with Versa specifications. Versa's liability pursuant to that warranty is limited to the replacement of the Versa product proved to be defective provided the allegedly defective product is returned to Versa or its authorized distributor.

Versa provides no other warranties, expressed or implied, except as stated above. There are no implied warranties of merchantability or fitness for a particular purpose. Versa's liability for breach of warranty as herein stated is the only and exclusive remedy and in no event shall Versa be responsible or liable for incidental or consequential damages.

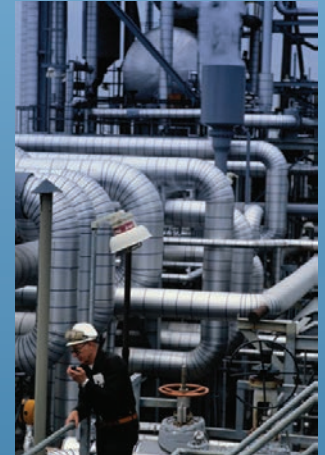

[www.versa-valves.com](http://www.versa-valves.com)

e-mail: [sales@versa-valves.com](mailto:sales@versa-valves.com)